



Australian Government

Department of Resources,  
Energy and Tourism

Geoscience Australia

[abare.gov.au](http://abare.gov.au)

# Australian Energy Resource Assessment



**Department of Resources, Energy and Tourism**

Minister for Resources and Energy: The Hon. Martin Ferguson, AM MP  
Secretary: Mr John Pierce

**Geoscience Australia**

A/g Chief Executive Officer: Dr Chris Pigram

**Australian Bureau of Agricultural and Resource Economics (ABARE)**

Executive Director: Phillip Glyde

© Commonwealth of Australia, 2010

This work is copyright. Apart from any fair dealings for the purpose of study, research, criticism, or review, as permitted under the Copyright Act 1968, no part may be reproduced by any process without written permission. Copyright is the joint responsibility of the Chief Executive Officer, Geoscience Australia and the Executive Director, ABARE. Requests and enquiries should be directed to the Chief Executive Officer, Geoscience Australia, GPO Box 378, Canberra ACT 2601 and the Executive Director, ABARE, GPO Box 1563, Canberra ACT 2601.

Geoscience Australia and ABARE have tried to make the information in this product as accurate as possible. However, it does not guarantee that the information is totally accurate or complete. Therefore, you should not solely rely on this information when making a commercial decision.

ISBN 978-1-921672-59-0 (hard copy)

ISBN 978-1-921672-58-3 (web)

GeoCat # 70142

Bibliographic reference: Geoscience Australia and ABARE, 2010, Australian Energy Resource Assessment, Canberra



**Australian Government**

**Department of Resources,  
Energy and Tourism**

**Geoscience Australia**

**abare.gov.au**

# *Australian* **Energy Resource Assessment**

**Department of Resources, Energy and Tourism**

GPO Box 9839

Canberra ACT 2601

[www.ret.gov.au](http://www.ret.gov.au)

**Geoscience Australia**

GPO Box 378

Canberra ACT 2601

[www.ga.gov.au](http://www.ga.gov.au)

**Australian Bureau of Agricultural  
and Resource Economics**

GPO Box 1563

Canberra ACT 2601

[www.abare.gov.au](http://www.abare.gov.au)

## Acknowledgments

This assessment and report was commissioned by the Australian Government Department of Resources, Energy and Tourism (RET) and jointly undertaken by Geoscience Australia and ABARE.

This report is the result of input from many individuals and agencies.

### *Assessment Team Leader*

Lynton Jaques

### *Authors*

**Geoscience Australia:** Lynton Jaques, Marita Bradshaw, Leesa Carson, Anthony Budd, Michael Huleatt, David Hutchinson, Ian Lambert, Steve LePoidevin, Aden McKay, Yanis Mieztis, Ron Sait, and Ron Zhu; and Michael Hughes (formerly of Geoscience Australia).

**ABARE:** Allison Ball, Clara Cuevas-Cubria, Alan Copeland, Lindsay Hogan, Michael Lampard, Apsara Maliyasena, Robert New, Kate Penney, and Rebecca Petchey; and Suwin Sandu, Suthida Warr and Rebecca McCallum (formerly of ABARE).

### *Other contributors*

A number of colleagues at Geoscience Australia, ABARE and the Department of Resources, Energy and Tourism (RET) have contributed to the preparation of this report.

Strategic guidance and support was provided by: Drew Clarke and Tania Constable (RET), Neil Williams and Chris Pigram (Geoscience Australia), Terry Sheales and Jane Melanie (ABARE).

The following people provided data or information, advice and/or reviews of draft chapters or sections:

**Geoscience Australia:** David Arnold, Andrew Barnicoat, Andrew Barrett, Tom Bernecker, Chris Boreham, Peter Harris, Andrew Heap, Bill McKay, Clinton Foster, Ed Gerner, Bruce Goleby, Riko Hashimoto, Subhash Jaireth, Aleks Kalinowski, John Kennard, Robert Langford, Gabriel Nelson, Peter Southgate, Phil Symonds, Jennie Totterdell, Helena Twells and George Webb.

**ABARE:** Lisa Elliston, Arif Syed and Andrew Schultz.

**RET:** Offshore Resources, Minerals, Fuels and Uranium, International, Resources Development and Taxation, and Low Emissions Coal and CO<sub>2</sub> Branches of the Resources Division; Energy Futures, Environment, National Energy Market Branch,

Clean Energy Initiative, and Industrial Energy Efficiency Branches of the Energy and Environment Division; Energy White Paper Secretariat.

### *Design and production*

Lindy Gratton (Geoscience Australia)

### *Graphics*

Silvio Mezzomo, Chris Evenden (Geoscience Australia), Tim Johns (formerly of Geoscience Australia)

### *Technical editing*

Denis Hally-Burton, Dean Hoatson, Elizabeth Fredericks (Geoscience Australia)

### *Other acknowledgements*

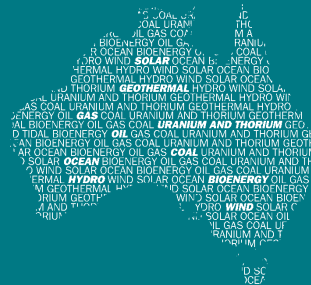
A number of individuals and organisations have kindly provided invaluable information and advice on this report. This is very much appreciated and thanks are extended particularly to:

- The Energy White Paper High Level Consultative Committee; Australian Coal Association; Australian Geothermal Energy Association Inc; Australian Petroleum Production and Exploration Association; Clean Energy Council; Australian Uranium Association; Queensland Government Department of Mines and Energy; and NSW Government Department of Industry and Investment;
- Individuals: Dr Michael Connarty (Hydro Tasmania), Dr Peter Coppin (CSIRO Marine and Atmospheric Research), Simon Eldridge (Queensland Energy Resources Ltd), Dr Agu Kantsler (Woodside), Andy Lloyd (Rio Tinto Australia), Dr Peter McCabe (CSIRO Petroleum Resources), Dr Deborah O'Connell (CSIRO Sustainable Ecosystems), Luke Osborne (Windlab Systems Pty Ltd), Dr Trevor Powell, Ray Prowse (Centre for Sustainable Energy Systems, Australian National University), Richard Schodde (MinEx Consulting Pty Ltd), Dr Jim Smitham (CSIRO Energy Technology), Dr Igor Skyrabin (Centre for Sustainable Energy Systems, Australian National University), Wes Stein (CSIRO Energy Technology), and John Titchen (formerly Hydro Tasmania).

Many agencies and individuals have given permission to use information from previous publications and reports and to reproduce images. While this is acknowledged at the appropriate location in the text, appreciation of each contribution is also extended here.



# Foreword



The Australian Energy Resource Assessment sets a new standard for supplying information across all energy sectors and understanding Australia's energy future.

Australia's energy resources are the envy of the world. We have an abundance of both fossil and renewable fuels, many with potential we are only now beginning to realise. Our energy resources power our homes, cars and industry, and deliver considerable economic benefits. The energy sector employs people in every state and territory and assists in the building of communities in remote areas.

Australia is in a unique position to support economic growth and growing global demand for energy. Nearly 20 cents in every dollar that Australia earns from overseas comes from energy resources and there is potential for much more. With new LNG projects getting up and running, by 2020 Australia can be the world's second largest LNG exporter behind Qatar. Exports of coal and uranium are also expected to grow strongly over the next two decades. Domestically the use of our vast renewable energy resources will increase.

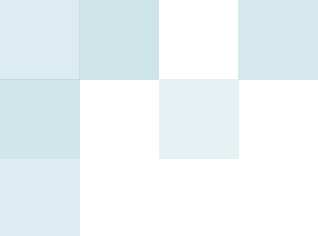
The Australian Energy Resource Assessment is a national prospectus for energy resources. It provides information crucial to those seeking to invest in Australian energy exploration and development, and describes in detail our known resources, and the potential for undeveloped resources both now and over the next two decades. It also increases understanding of our renewable resources which will assist investors seeking to develop these resources. As our energy use is constantly evolving, the Australian Energy Resource Assessment will also support informed decisions on future energy options.



By stimulating investment in the exploration and development of our energy resources we will ensure our economic prosperity, strengthen communities and develop skills for Australian workers. In a century when energy may come to be the defining global issue, we are committed to maintaining energy security for ourselves and contributing to the energy security of our trading partners.

The Australian Energy Resource Assessment is part of our vision for the future. A future where all Australians benefit from Australia's energy resources.

**Martin Ferguson AM MP**  
**Minister for Resources and Energy**



# Preface



The secure supply of affordable, reliable, environmentally sustainable energy is essential to Australia's future economic growth and prosperity. Australia's future energy supply will need to have lower greenhouse gas emissions in order to meet the challenges posed by climate change driven by rising levels of carbon dioxide in the Earth's atmosphere. This requires a higher level of understanding of Australia's energy resources and the factors likely to affect their development and use.

Geoscience Australia and ABARE were commissioned by the Australian Government Department of Resources, Energy and Tourism to undertake a comprehensive and integrated scientific and economic assessment of Australia's energy resources. The assessment aims to inform future industry investment analysis and decision making and government policy development. It is the first time such an assessment has been undertaken.

**Geoscience Australia** is the Australian Government's geoscience agency which provides geoscientific information and knowledge to enable government and the community to make informed decisions about the exploitation of resources, the management of the environment, and the safety of critical infrastructure.

The **Australian Bureau of Agricultural and Resource Economics (ABARE)** is the Australian Government's economic research agency which provides independent economic research, analysis and forecasting on issues relating to Australia's agricultural, fishing, forestry, and energy and minerals industries.

The assessment brings together public information from a range of domestic and international sources, as well as the latest information held by Geoscience Australia and ABARE. For each of these resources, information and analysis is provided on current and potential resource size, distribution and characteristics, and the Australian and world markets. It also contains market projections to 2030 and analysis of prices, costs, government policies, technological developments, environmental considerations and other key factors likely to affect the development and utilisation of the resource.

In particular, **renewable energy resources** – energy resources that are replaced naturally on a time scale similar to their use – are expected to play an

increasingly important role in Australia's energy mix in the next two decades, especially in electricity generation. Renewable energy resources are diverse. They include geothermal; hydro; wind; solar; ocean; and bioenergy sources.

**Non-renewable energy resources** will also continue to play an important role in Australia and overseas. These resources are dominated by the fossil fuels, which include: crude oil, condensate, liquefied petroleum gas and shale oil; conventional gas, coal seam gas, tight gas and shale gas; and black and brown coal, as well as the nuclear energy fuels uranium and thorium (potential). The stock of non-renewable energy resources is ultimately finite, but there is still good potential for discovering new economic reservoirs to replace the resources that are mined or produced, and so ensure future indigenous supply.

The assessment covers the following resources:

- crude oil, condensate, liquefied petroleum gas, and shale oil;
- conventional gas, coal seam gas, tight gas, shale gas, and gas hydrates;
- black and brown coal;
- uranium and thorium;
- geothermal;
- hydro;
- wind;
- solar;
- ocean (wave, tidal, and ocean thermal); and
- bioenergy,

and is structured as follows.

**Chapter 1** presents a summary of the assessment and identifies key findings.

**Chapter 2** is an overview of Australia's energy resource base and market. It provides a holistic assessment of our combined energy resources, energy-related infrastructure, and Australian energy consumption, production and trade, as well as our place in the world energy market. It also assesses the key factors likely to affect the development and utilisation of Australia's energy resources in the next two decades, including economic and population growth, energy prices, cost competitiveness of energy sources, government policies, technological developments and environmental considerations.

**Chapters 3 to 12** contain detailed individual assessments for each of Australia's key energy

resources. Each resource assessment follows a similar structure. The first part is a summary of the key information in the chapter. The second part includes background with definitions, the structure of the industry and the world market. The third part covers detailed information on the resources, such as economic and total demonstrated resources, location and characteristics. It also provides information on the Australian market for that resource, including production, consumption, recent growth, and any trade that occurs. The fourth part contains an outlook to 2030, which is a critical part of the assessment. It includes an assessment of the key factors that will affect the resource over that 20-year timeframe, including prices, cost of development, government policies, technological developments, infrastructure and environmental considerations. It also includes analysis of potential resources not yet identified, as well as projections of production, consumption, and any trade to 2029–30. These projections incorporate the Renewable Energy Target of 20 per cent of electricity supply by 2020 and a 5 per cent carbon emissions reduction below 2000 levels by 2020.

These assessments are supported by a number of Appendices. The Terms of Reference for the assessment are given in **Appendix A**. **Appendix B** contains a list of abbreviations used in this report and **Appendix C** provides a glossary of energy-related terms. An authoritative and rigorous form of resource classification, particularly for non-renewable resources, is central to ensuring that investment decisions can be made with confidence. **Appendix D** provides an explanation of how the non-renewable resources are classified and quantified, based largely on the McKelvey resource classification system. Renewable energy resources are commonly transient and not always

available, and hence not readily classified using the McKelvey system. Renewable resources are often reported in terms of output or installed capacity. Estimates of renewable resource potential are based on maps that show the energy (or power) potentially or theoretically available at the site and detailed studies of the annual and diurnal variation in the energy to determine the capacity factor (the average actual energy output compared with the theoretical maximum possible output if the energy was continuously and fully available for use).

In this assessment, energy resources, production, consumption and trade have generally been converted to a common energy unit – petajoules (PJ) – to enable direct comparison of different energy sources. Mineral and petroleum resources are also presented in volume or mass units commonly used in industry.

The energy content of the different energy sources varies significantly. Fuels such as oil, natural gas, LNG and LPG generally have a high energy content, whereas brown coal and biomass generally have a low energy content for an equivalent weight. The energy content in this context is the gross energy content of the fuel – that is, the total amount of heat that will be released by combustion. Average energy contents and conversion factors are given in **Appendix E**. The values are indicative only because the quality of any fuel varies according to factors such as location and air pressure, grade of the resource, and so on.

Australia’s petroleum and mineral resources have been formed by geological processes acting within a time scale of millions of years. The geological time scale and the timing of major energy forming events in Australia is given in **Appendix F**.



# Contents



<b>Acknowledgments</b>	<b>ii</b>
<b>Foreword</b>	<b>iii</b>
<b>Preface</b>	<b>v</b>
<b>Chapter 1: Executive Summary</b>	<b>1</b>
1.1 Summary	1
1.2 Introduction	2
1.3 Australia in the world energy market	2
1.4 Australia's energy resources and market	3
1.5 Outlook for Australia's energy resources and market to 2030	5
<b>Chapter 2: Australia's Energy Resources and Market</b>	<b>9</b>
2.1 Summary	9
2.1.1 Australia in the world energy market	9
2.1.2 Australia's energy resources and infrastructure	10
2.1.3 Australia's energy market to 2030	11
2.2 Australia in the world energy market	12
2.2.1 Current world market snapshot	13
2.2.2 World energy market outlook to 2030	14
2.3 Australia's energy resources and infrastructure	18
2.3.1 Australia's energy resource base	18
2.3.2 Distribution, ownership and administration of energy resources	22
2.3.3 Energy infrastructure	23
2.4 Australia's energy market to 2030	26
2.4.1 Energy market drivers	26
2.4.2 Overview of Australian energy production, consumption and trade	33
2.4.3 Outlook for Australia's energy market	35
2.5 References	40
<b>Chapter 3: Oil</b>	<b>41</b>
3.1 Summary	41
3.1.1 World oil resources and market	41
3.1.2 Australia's oil resources	41
3.1.3 Australia's oil market	42
3.2 Background information and world market	43
3.2.1 Definitions	43
3.2.2 Oil supply chain	44
3.2.3 World oil market	47
3.3 Australia's oil resources and market	51
3.3.1 Crude oil resources	51

3.3.2	Condensate resources	52
3.3.3	LPG resources	55
3.3.4	Shale oil resources	56
3.3.5	Total oil resources	59
3.3.6	Oil market	60
3.4	Outlook to 2030 for Australia's resources and market	64
3.4.1	Key factors influencing the outlook	64
3.4.2	Outlook for oil resources	74
3.4.3	Outlook for oil market	78
3.5	References	81
<b>Chapter 4: Gas</b>		<b>83</b>
4.1	Summary	83
4.1.1	World gas resources and market	83
4.1.2	Australia's gas resources	83
4.1.3	Key factors in utilising Australia's gas resources	85
4.1.4	Australia's gas market	85
4.1.5	Outlook to 2030 for the Australian gas market	85
4.2	Background information and world market	86
4.2.1	Definitions	86
4.2.2	Gas supply chain	87
4.2.3	World gas market	90
4.3	Australia's gas resources and market	95
4.3.1	Conventional gas resources	95
4.3.2	Coal seam gas (CSG) resources	96
4.3.3	Tight gas, shale gas and gas hydrates resources	98
4.3.4	Total gas resources	99
4.3.5	Gas market	100
4.4	Outlook to 2030 for Australia's resources and market	106
4.4.1	Key factors influencing the outlook	106
4.4.2	Conventional gas resource outlook	116
4.4.3	Unconventional gas resource outlook	119
4.4.4	Total gas resource outlook	120
4.4.5	Outlook for gas market	120
4.5	References	129
<b>Chapter 5: Coal</b>		<b>131</b>
5.1	Summary	131
5.1.1	World coal resources and market	131
5.1.2	Australia's coal resources	131
5.1.3	Key factors in utilising Australia's coal resources	132
5.1.4	Australia's coal market	133
5.2	Background information and world market	134
5.2.1	Definitions	134
5.2.2	Coal supply chain	135
5.2.3	World coal market	137
5.3	Australia's coal resources and market	141
5.3.1	Coal resources	141
5.3.2	Coal market	146

5.4	Outlook to 2030 for Australia's resources and market	149
5.4.1	Key factors influencing the outlook	149
5.4.2	Outlook for coal market	163
5.5	References	170
<b>Chapter 6: Uranium and Thorium</b>		<b>171</b>
6.1	Summary	171
6.1.1	World uranium and thorium resources and market	171
6.1.2	Australia's uranium and thorium resources	171
6.1.3	Key factors in utilising Australia's uranium and thorium resources	172
6.1.4	Australia's uranium and thorium market	172
6.2	Uranium	173
6.2.1	Background information and world market	173
	Definitions	173
	Uranium supply chain	173
	World uranium market	175
6.2.2	Australia's uranium resources and market	180
	Uranium resources	180
	Uranium market	181
6.2.3	Outlook to 2030 for Australia's resources and market	185
	Key factors influencing the outlook	185
	Outlook for uranium resources	190
	Outlook for uranium market	193
6.3	Thorium	196
6.3.1	Background information and world market	196
	Definitions	196
	Thorium supply chain	196
	World thorium market	196
6.3.2	Australia's thorium resources and market	198
	Thorium resources	198
	Thorium market	199
6.3.3	Outlook to 2030 for Australia's resources and market	199
	Key factors influencing the outlook	199
6.4	References	201
<b>Chapter 7: Geothermal Energy</b>		<b>203</b>
7.1	Summary	203
7.1.1	World geothermal resources and market	203
7.1.2	Australia's geothermal resources	203
7.1.3	Key factors in utilising Australia's geothermal resources	204
7.1.4	Australia's geothermal energy market	205
7.2	Background information and world market	205
7.2.1	Definitions	205
7.2.2	Geothermal energy supply chain	207
7.2.3	World geothermal energy market	208
7.3	Australia's geothermal resources and market	212
7.3.1	Geothermal resources	212
7.3.2	Geothermal energy market	216

7.4	Outlook to 2030 for Australia's geothermal resources and market	218
7.4.1	Key factors influencing the future development of Australia's geothermal energy resources	218
7.4.2	Outlook for geothermal energy market	222
7.5	References	223

## **Chapter 8: Hydro Energy** **225**

8.1	Summary	225
8.1.1	World hydro energy resources and market	225
8.1.2	Australia's hydro energy resources	225
8.1.3	Key factors in utilising Australia's hydro energy resources	225
8.1.4	Australia's hydroelectricity market	225
8.2	Background information and world market	226
8.2.1	Definitions	226
8.2.2	Hydroelectricity supply chain	228
8.2.3	World hydroelectricity market	228
8.3	Australia's hydro energy resources and market	232
8.3.1	Hydro energy resources	232
8.3.2	Hydroelectricity market	233
8.4	Outlook to 2030 for Australia's hydro energy resources and market	235
8.4.1	Key factors influencing the outlook	235
8.4.2	Outlook for hydroelectricity market	237
8.5	References	237

## **Chapter 9: Wind Energy** **239**

9.1	Summary	239
9.1.1	World wind energy resources and market	239
9.1.2	Australia's wind energy resources	239
9.1.3	Key factors in utilising Australia's wind energy resources	239
9.1.4	Australia's wind energy market	240
9.2	Background information and world market	241
9.2.1	Definitions	241
9.2.2	Wind energy supply chain	241
9.2.3	World wind energy market	242
9.3	Australia's wind energy resources and market	246
9.3.1	Wind energy resources	246
9.3.2	Wind energy market	247
9.4	Outlook to 2030 for Australia's wind energy resources and market	248
9.4.1	Key factors influencing the future development of Australia's wind resources	248
9.4.2	Outlook for wind energy market	255
9.5	References	260

## **Chapter 10: Solar Energy** **261**

10.1	Summary	261
10.1.1	World solar energy resources and market	261
10.1.2	Australia's solar energy resources	261
10.1.3	Key factors in utilising Australia's solar resources	261
10.1.4	Australia's solar energy market	262



10.2	Background information and world market	262
10.2.1	Definitions	262
10.2.2	Solar energy supply chain	264
10.2.3	World solar energy market	264
10.3	Australia's solar energy resources and market	268
10.3.1	Solar resources	268
10.3.2	Solar energy market	271
10.4	Outlook to 2030 for Australia's resources and market	274
10.4.1	Key factors influencing the future development of Australia's solar energy resources	275
10.4.2	Outlook for solar energy market	277
10.5	References	283
<b>Chapter 11: Ocean Energy</b>		<b>285</b>
11.1	Summary	285
11.1.1	World ocean energy resources and market	285
11.1.2	Australia's ocean energy resources	285
11.1.3	Key factors in utilising Australia's ocean energy resources	285
11.1.4	Australia's ocean energy market	286
11.2	Background information and world market	286
11.2.1	Definitions	286
11.2.2	Ocean energy supply chain	288
11.2.3	World ocean energy market	288
11.3	Australia's ocean energy resources and market	291
11.3.1	Ocean energy resources	291
11.3.2	Ocean energy market	298
11.4	Outlook to 2030 for Australia's ocean energy resources and market	298
11.4.1	Key factors influencing the future development of Australia's ocean resources	299
11.4.2	Outlook for ocean energy resources	303
11.4.3	Outlook for ocean energy market	303
11.5	References	308
<b>Chapter 12: Bioenergy</b>		<b>309</b>
12.1	Summary	309
12.1.1	World bioenergy resources and market	309
12.1.2	Australia's bioenergy resources	309
12.1.3	Key factors in utilising Australia's bioenergy resources	309
12.1.4	Australia's bioenergy market	310
12.2	Background information and world market	310
12.2.1	Definitions	310
12.2.2	Bioenergy supply chain	311
12.2.3	World bioenergy market	312
12.3	Australia's bioenergy resources and market	316
12.3.1	Bioenergy resources	316
12.3.2	Bioenergy market	319
12.4	Outlook to 2030 for Australia's resources and market	322
12.4.1	Key factors influencing the outlook	322
12.4.2	Outlook for bioenergy resources	328
12.4.3	Outlook for bioenergy market	331
12.5	References	333



## Appendices

335

**Appendix A:** Australian Energy Resource Assessment Terms of Reference

335

**Appendix B:** Abbreviations and Acronyms

336

**Appendix C:** Glossary

337

**Appendix D:** Resource Classification

339

**Appendix E:** Energy Measurement and Conversion Factors

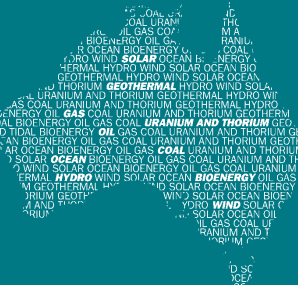
341

**Appendix F:** Geological Time Scale and Formation of Australia's Major Energy Resources

344

# Chapter 1

## Executive Summary



### 1.1 Summary

#### KEY MESSAGES

- This national assessment of Australia's energy resources examines Australia's identified and potential energy resources ranging from fossil fuels and uranium to renewables. It reviews and assesses the factors likely to influence the use of Australia's energy resources to 2030 including the technologies being developed to extract energy more efficiently and cleanly from existing and new energy sources.
- Australia has an abundance and diversity of energy resources. Australia has more than one third of the world's known economic uranium resources, very large coal (black and brown) resources that underpin exports and low-cost domestic electricity production, and substantial conventional gas and coal seam gas resources. This globally significant resource base is capable of meeting both domestic and increased export demand for coal and gas, and uranium exports, over the next 20 years and beyond. There is good potential for further growth of the resource base through new discoveries. Identified resources of crude oil, condensate and liquefied petroleum gas (LPG) are more limited and Australia is increasingly reliant on imports for transport fuels.
- Australia has a rich diversity of renewable energy resources (wind, solar, geothermal, hydro, wave, tidal, bioenergy). Except for hydro where the available resource is already mostly developed and wind energy where use is growing strongly, these resources are largely undeveloped and could contribute significantly more to Australia's future energy supply.
- Greater use of many energy sources with lower greenhouse gas emissions (especially renewable energy sources) is currently limited by the immaturity of technologies and the cost of electricity production. Advances in technology supported by industry and government actions are expected to result in commercial electricity production by 2030 from sources that are currently only at the demonstration stage.
- Australia's energy usage in 2030 is expected to differ significantly from that of today under the influence of the 20 per cent Renewable Energy Target and other government policies such as the proposed emissions reduction target. In addition the Government has established the Clean Energy Initiative which includes the Carbon Capture and Storage and Solar Flagship Programs, and the Australian Centre for Renewable Energy.
- Australia's long-term energy projections show total energy production nearly doubling due to strong export demand, primary energy consumption rising by 35 per cent, and electricity demand increasing by nearly 50 per cent by 2030. Whilst coal is expected to continue to dominate Australia's electricity generation, a shift to lower-emissions fuels is expected to result in a significant reduction in coal's share and increases in gas and renewable energy, particularly wind.
- Australia's energy infrastructure is concentrated in areas where energy consumption is highest and major fossil fuel energy resources are located. Greater use of new energy resources, particularly renewable energy sources, will require expansion of Australia's energy infrastructure, including augmentation of the electricity transmission grid.

## 1.2 Introduction

Australia's abundance of energy is a key contributor to Australia's economic prosperity. The Australian energy sector directly accounts for 5 per cent of gross industry value-added; 20 per cent of total export value; supports a large range of manufacturing industries; and provides significant employment and infrastructure. The demand for energy is increasing as Australia's economy and population grow.

A secure supply of adequate, clean, reliable energy at an affordable price is vital for Australia's economic growth and prosperity. To date Australia's energy needs have been largely met by fossil fuels. Australia's abundant and low-cost coal resources are used to generate three-quarters of domestic electricity and underpin some of the cheapest electricity in the world. Australia's transport system is heavily dependent on oil, some of which is imported.

Australia's economy, and the energy sector in particular, is undergoing transformational change to reduce greenhouse gas emissions and help mitigate the impacts of global climate change. The energy sector currently accounts for more than half of Australia's net carbon dioxide (CO<sub>2</sub>) emissions. The move to a lower emissions economy requires a shift from the current heavy dependence on fossil fuels to a greater use of energy sources and technologies that reduce carbon emissions, such as renewable energy and carbon capture and storage. At present renewable energy sources account for only modest proportions of Australia's primary energy consumption (around 5 per cent) and electricity generation (7 per cent), although their use has been increasing strongly in recent years. Recent and proposed developments in Australia's energy policy seek to significantly boost the role that renewable energy plays in the next two decades.

The objective of this report by Geoscience Australia and the Australian Bureau of Agricultural and Resource Economics (ABARE) is to provide a comprehensive and integrated assessment of Australia's energy resources to assist industry investment decision-making and development of government policy on energy resources. Included in the outlook to 2030 is an assessment of Australia's identified and potential energy resources; a review of the technologies being developed to extract energy more efficiently and cleanly from both existing and emerging energy sources; and consideration of other factors such as the global energy market that are likely to influence the development and use of Australia's energy resources in the next 20 years.

The assessment is made against a background of significant change and uncertainty about future

energy demand and use, both in Australia and globally. World economies – including Australia and its major trading partners – are still recovering from the economic downturn associated with the global financial crisis in 2008–09. Preliminary International Energy Agency (IEA) data suggest that world energy demand dipped by up to 2 per cent in 2009, the first decline in energy consumption since 1981.

The rate of growth of future global energy demand is uncertain and will strongly depend on global policies and actions to reduce CO<sub>2</sub> levels in the Earth's atmosphere. Without such actions, global energy demand is expected to continue to grow robustly over the next twenty years, dominated by fossil fuels. The adoption of emissions reduction policies could be expected to constrain growth in energy demand and raise the price of fossil fuels, increasing the attractiveness of lower carbon technologies, especially renewable energy.

As the global economy recovers and energy demand grows, the response by governments in Australia and globally to climate change will largely determine future energy demand. This in turn will impact on demand for Australia's energy resources both as exports to the world markets and the nature of Australia's domestic energy consumption.

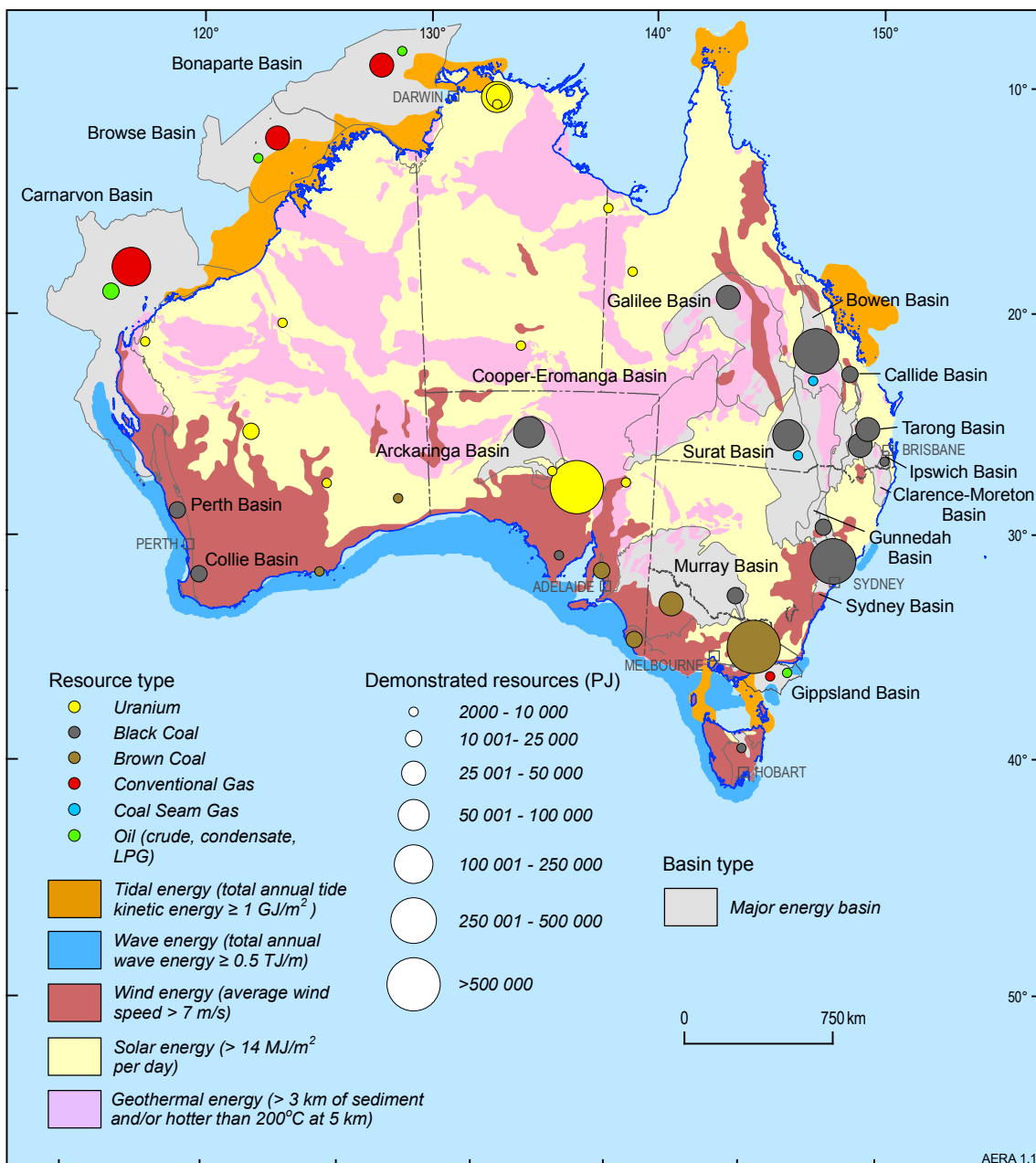
## 1.3 Australia in the world energy market

- Australia is richly endowed with natural energy resources and holds an estimated 38 per cent of uranium resources, 9 per cent of coal resources, and 2 per cent of natural gas resources in the world.
- Australia produces about 2.4 per cent of world energy and is a major supplier of energy to world markets, exporting more than three-quarters of its energy output. In 2008–09 Australia's energy exports reached nearly 14 000 PJ, worth \$77.9 billion.
- Australia is currently the world's largest exporter of coal and coal exports accounted for more than half of exports on an energy content basis. Australia is one of the world's largest exporters of uranium, and is ranked sixth in terms of liquefied natural gas (LNG) exports. In contrast, Australia has only about 0.3 per cent of world oil reserves. Net imports of liquid fuels account for nearly half of consumption.
- Australia is the world's twentieth largest consumer of energy, and fifteenth in terms of per capita energy use.

- Australia’s energy market differs from that of many other OECD countries and world energy markets. Coal plays a much larger role in Australia’s primary fuel mix, reflecting Australia’s large, low-cost resources located near demand centres and close to the eastern seaboard. The penetration of gas in Australia is similar to that of the OECD and world average, as is that of wind and solar. On the other hand, Australia has less hydro energy resources, makes less use of bioenergy than some countries, and does not use nuclear power.

### 1.4 Australia’s energy resources and market

- Australia’s energy production was 17 360 PJ in 2007–08. The main energy sources produced, on an energy content basis, were coal (54 per cent), uranium (27 per cent) and gas (11 per cent). Renewable energy accounts for nearly 2 per cent of total production.
- Primary energy consumption was 5772 PJ in 2007–08. Coal accounted for around 40 per cent of this, followed by oil (34 per cent) and gas



**Figure 1.1** Australia’s major energy resources, excluding hydro and bioenergy

**Note:** Total resources are in many cases significantly larger than the remaining demonstrated resources which do not include inferred and potential (yet to be discovered) resources.

**Source:** Geoscience Australia

(22 per cent). Renewable energy accounts for 5 per cent of primary energy consumption, most of which is bioenergy. Wind and solar account for only 0.3 per cent of primary energy consumption.

- Total electricity production was around 925 PJ (257 TWh) in 2007–08. Coal accounts for about three-quarters of Australia's electricity generation, followed by gas (16 per cent). Renewable energy sources account for an estimated 7 per cent of electricity generation, most of which is hydro.
- Australia has abundant, high quality fossil fuel resources, notably coal (black and brown) and gas (conventional, coal seam gas and potentially tight gas) resources which are widely distributed across the country (table 1.1; figure 1.1). Resources of oil (crude oil, condensate, and LPG) are more limited (especially crude oil resources), and Australia relies increasingly on imports to meet demand for transport fuels. With the exception of crude oil, Australia's fossil fuel resources are expected to last for many more decades, even with increased levels of production.
- Coal is Australia's largest energy resource. About 70 per cent of Australia's large, low-cost economic demonstrated resources (EDR) of black coal (883 400 PJ, 39 Gt) are located in the Sydney and Bowen basins but the total identified coal resource is much larger (about 2.5 million PJ, 114 Gt) and more broadly distributed and includes major undeveloped resources in additional areas such as the Gunnedah, Arckaringa, Surat and Galilee basins in Queensland, South Australia and New South Wales. Australia's EDR of black coal are sufficient for about 90 years at 2008 production levels. Australia is the world's largest exporter of metallurgical coal and the second largest exporter of thermal coal, with total coal exports worth \$54.7 billion in 2008–09.
- Brown coal resources are similarly large and concentrated in the Gippsland Basin (Victoria) where they are used for electricity generation. There are also substantial undeveloped resources in the Murray Basin. Australia's EDR of brown coal are sufficient for nearly 500 years at 2008 production levels.
- Australia has the world's largest uranium resources with reasonably assured resources of uranium recoverable at less than US\$80/kg (equivalent to EDR) estimated to be 651 280 PJ (1163 kt U), equivalent to about 140 years at 2008 production levels. High levels of exploration are expected to add to the resource base. Australia is one the world's leading exporters of uranium and has a number of proposed new mines to meet increasing world demand. Australia

also has a major share of the world's thorium resources, a potential future nuclear fuel.

- Gas is Australia's third largest energy resource. Australia's has significant conventional gas resources lying mostly offshore in the Carnarvon, Browse and Bonaparte basins off the north-west coast of Western Australia with smaller resources in south-east (Gippsland Basin) and central Australia. These support growing domestic demand in the three gas markets as well as LNG exports (15.4 Mt, \$10.1 billion in 2008–09) from Western Australia and the Northern Territory. Current demonstrated (economic and sub-economic) resources of conventional gas stand at 180 400 PJ (164 tcf). EDR are adequate for 63 years at current rates of production. These figures do not include the gas resources in recent discoveries which are not yet fully defined, the resources likely to be added by reserves growth nor resources from potential new discoveries. Significant additional export capacity is also under construction and proposed.
- Australia also has significant unconventional gas resources, especially coal seam gas (CSG) resources associated with the major coal basins of eastern Australia. CSG resources and production have grown strongly and CSG is playing an increasingly important role in eastern gas markets. CSG EDR are estimated to be 16 590 PJ (15 tcf) but total demonstrated resources exceed 46 590 PJ with more likely to be available from the even larger estimated potential in-ground CSG resources. Plans have been announced for CSG-based LNG projects in Queensland.
- Australia's oil resources are in decline with remaining crude oil resources estimated to be 8414 PJ (1431 million barrels, mmbbl) and located mostly in the Carnarvon and Gippsland basins. Australia's total liquid petroleum resources are boosted to 30 794 PJ by the condensate (16 170 PJ, 2750 mmbbl) and LPG (6210 PJ, 1475 mmbbl) resources associated with major, largely undeveloped gas fields in the Carnarvon, Browse and Bonaparte basins off the north-west coast of Australia. Australia's oil resources could be extended by new discoveries in deep water basins (both proven and untested) and further growth at existing fields. Without significant new discoveries of crude oil, or development of condensate and LPG resources associated with offshore gas resources, or other alternatives, Australia is likely to be increasingly dependent on imports for transport fuels.
- Australia also has significant demonstrated shale oil resources of around 84 600 PJ (14 387 mmbbl) that are currently not utilised



because of economic and environmental constraints.

- Australia's potential renewable resource base is also very large, and includes wind, solar, bioenergy, geothermal, wave and tide as well as hydro resources. Hydro and increasingly wind energy are used in electricity generation. Biomass and solar energy are both being used for heating and electricity generation. However, Australia's renewable energy resources are largely undeveloped: a number involve technologies still at the proof-of-concept or early stages of commercial demonstration.
- Australia's hydro electric power stations have a combined installed capacity of 7.8 GW and produce about 4.5 per cent of Australia's total electricity, the largest contribution of any renewable energy. Most are located in Tasmania and in the Snowy Mountain Hydro-Electric Scheme in south-east Australia where they account for about 60 per cent and 20 per cent of electricity generation in Tasmania and New South Wales, respectively. However, water availability is a key constraint on future growth in hydro energy in Australia.
- Australia's wind resources are among the best in the world, primarily located in western, south-western, southern and south-eastern coastal regions but extending hundreds of kilometres inland. These resources are being progressively utilised by an increasing number of large-scale (more than 100 MW) wind farms using large modern wind turbines. Wind energy is the fastest-growing energy source with an installed capacity of about 1.7 GW, which produced about 1.5 per cent of Australia's electricity in 2007–08.
- High solar radiation levels over large areas of the continent provide Australia with some of the best solar resources in the world. Use of solar energy is currently modest (around 0.1 per cent of Australia's primary energy consumption) consisting mainly of off-grid and residential installations using solar thermal water heating with lesser production of electricity from photovoltaic (PV) cells. Substantial research and development programs in both government and industry are aimed at developing and commercialising large scale solar energy.
- Australia has significant (Hot Rock) geothermal energy potential associated with buried heat-producing (from natural radioactive decay) granites that could be a source of low emissions base load electricity generation. Lower temperature geothermal resources are associated with naturally-circulating waters in aquifers deep in sedimentary basins and are potentially suitable for electricity generation and/or direct use. Several projects are at the exploration, proof-of-concept or early commercial demonstration stage. Potential also exists for use of ground source heat pumps in heating and cooling buildings.
- Ocean energy (wave and tidal) is a potential new source of energy. Australia has a world-class wave energy potential along its south-western and southern coast with high energy densities, and large areas experiencing constant favourable wave heights (exceeding 1 m). Australia also has significant tidal energy resources, including an average kinetic energy resource of around 2.4 PJ at any time, located mostly along Australia's northern coastline. A number of technologies are being trialled at various sites.
- Bioenergy is a diverse energy source based on biomass (organic matter) that can be used to generate heat and electricity and to produce liquid transport fuels. Bioenergy currently accounts for about 4 per cent of Australia's primary energy consumption with the biggest contributors being bagasse (sugar cane residue) and wood waste in heating and electricity generation with some capture of methane gas from landfill and sewage facilities. A small amount of transport fuel (ethanol and biodiesel) is also produced. Greater use of bioenergy could be made through increased use of agricultural residues and wastes, wood waste, and non-edible biomass, including new generation crops.
- Current impediments to immediate large scale utilisation of Australia's substantial and diverse renewable resources include their generally higher costs relative to other energy sources (except for hydro), their often remote location from markets and infrastructure, and the relative immaturity (except for hydro and wind) of many renewable technologies.

## 1.5 Outlook for Australia's energy resources and market to 2030

- Significant changes are anticipated in the Australian energy market over the next two decades as a consequence of the expanded Renewable Energy Target (RET) and other government policies. Other factors expected to affect the market include the rate of economic and population growth, energy prices, and costs and developments in alternative energy technologies. Domestic use of nuclear power is not considered in the outlook period.

- Technology is expected to play a critical role in the transition toward a lower emissions economy. This includes technology to improve efficiency in extraction and use of energy, to reduce costs of cleaner technologies, and to develop and commercialise new technologies to access new energy sources.
- Australia's energy demand will continue to rise over the period to 2030, but the rate of growth is expected to continue to slow. This reflects the long term trend in the Australian economy toward less energy intensive sectors, and energy efficiency improvements both of which can be expected to be reinforced by policy responses to climate change. The contribution of gas and renewables is expected to increase significantly.
- ABARE's latest long-term Australian energy projections examine the effects of a 5 per cent emissions reduction target below 2000 levels by 2020, combined with the RET (20 per cent of electricity supply by 2020) and other existing policy measures, on Australia's energy market.
- Australia's total energy production (including uranium exports), is projected to increase by 3.2 per cent per year to reach around 35 057 PJ by 2029–30.
- Australia's primary energy consumption is projected to increase by 1.4 per cent per year to reach around 7715 PJ by 2029–30. The primary fuel mix is expected to change significantly, with the share of coal expected to decline to 23 per cent by 2029–30. In contrast, the share of gas is expected to rise to 33 per cent and wind to 2 per cent. Renewable energy is projected to account for 8 per cent of Australian energy consumption by 2029–30.
- Electricity generation is projected to reach 366 TWh in 2029–30, an increase of 1.8 per cent per year. Coal is expected to continue to dominate Australia's electricity generation (43 per cent of total in 2029–30) but a shift to lower emissions energy sources is expected to result in significant increases in the use of gas (37 per cent) and renewables (19 per cent), particularly wind (12 per cent).
- Australia's energy infrastructure is concentrated in areas where energy consumption is highest and major fossil fuel energy resources are located, particularly along the eastern seaboard of Australia. A significant expansion in Australia's energy infrastructure, particularly electricity generation and transmission, will be required in the next two decades if Australia is to meet its changing demand for energy. Utilising new energy resources, particularly renewable energy sources, will require a more flexible and decentralised electricity transmission grid.
- Australia's energy exports are projected to continue to grow to 2030 to meet rising global demand for energy. Net energy trade is projected to increase by 3.9 per cent per year, to reach 27 340 PJ in 2029–30. Exports of coal, uranium and LNG are all expected to rise significantly.
- World primary energy demand is projected to increase by 40 per cent between 2007 and 2030, representing an average annual growth rate of 1.5 per cent, in the IEA 2009 World Energy Outlook reference scenario. More than three-quarters of the increase in primary energy demand will continue to be for fossil fuels. Of the fossil fuels, coal is expected to be the fastest growing fuel and is projected to account for 29 per cent of world primary energy demand in 2030 (slightly higher than its current share), followed by gas which is projected to maintain its current share of 21 per cent. Renewable energy sources are projected to account for 14 per cent of primary energy use in 2030.
- Under a scenario where countries adopt emission reduction policies to stabilise the concentration of greenhouse gas emissions in the atmosphere at 450 parts per million of CO<sub>2</sub>-equivalent (the IEA's 450 scenario), growth in world energy demand to 2030 is projected to be significantly constrained, rising by only 20 per cent on current levels. Lower demand for coal would see the share of coal in the primary energy mix fall sharply (to 18 per cent in 2030). Renewable energy and nuclear power drive much of the growth in energy demand, with the share of renewables in primary energy use to rise more sharply (to 22 per cent).
- The energy sector, especially fossil fuels, will continue to play an important role in the Australian economy both in terms of domestic energy supply and increasingly in exports. However, it is clear that the transition to a low carbon economy will require long term structural adjustment in the Australian energy sector.
- While Australia has an abundance of energy resources, this transformation will need to be underpinned by significant investment in energy supply chains to allow for better integration of renewable energy sources and emerging technologies into our energy systems.



**Table 1.1** Summary of Australia's energy resources, December 2008

Resource	Development status	Economic demonstrated resources PJ	Total demonstrated resources PJ	Production 2007–08 PJ	Installed electricity generation capacity GW	Electricity production 2007–08 TWh	Export value 2008–09 \$million
<b>Non-renewable energy resources</b>							
Black coal	Electricity generation, exports of thermal and metallurgical coal	883 400	1 046 500	8722	24	143	54 671
Uranium <sup>a</sup>	Exports	651 280	660 240	4747	-	-	990
Brown coal	Electricity generation	362 000	896 300	709	6.7	60	-
Conventional gas	Electricity generation, direct use, LNG exports	122 100	180 400	1709	14	42 (includes CSG)	10 086
Coal seam gas (CSG)	Electricity generation, direct use, proposed LNG exports	16 590	46 590	124	Included in conventional gas	Included in conventional gas	-
Condensate	Transport fuel	12 560	16 170	257	-	-	Included in crude oil
Crude oil	Transport fuel	6950	8414	697	1 (distillate)	-	8755 (-5966 net exports)
LPG	Transport fuel	4614	6210	105	-	-	1044
Oil shale	Undeveloped resource	Economic evaluation of resources in progress	84 600	-	-	-	-
Thorium <sup>a, b</sup>	Undeveloped potential resource	No commercial market at present	76 kt	-	-	-	-
<b>Renewable energy resources</b>							
Geothermal	Undeveloped large Hot Rock and Hot Sedimentary Aquifer resources, not fully defined	Economic evaluation dependent on demonstration projects in progress	Exceeds 2 572 280 <sup>c</sup>	0.003 <sup>d</sup>	0.0001	0.0007 <sup>d</sup>	-
Hydro	Electricity generation; resource largely developed	30 TWh/year <sup>e</sup> (gross economically exploitable capacity)	100 TWh/year <sup>e</sup> (technically exploitable capacity)	43	7.8	12	-

Resource	Development status	Economic demonstrated resources PJ	Total demonstrated resources PJ	Production 2007–08 PJ	Installed electricity generation capacity GW	Electricity production 2007–08 TWh	Export value 2008–09 \$million
Wind	Electricity generation; large potential resources	Substantial economic resource, large-scale commercial wind farms in operation	More than 600 000 km <sup>2</sup> with average wind speeds of 7 m/s or higher	14	1.7	3.9	-
Solar	Large potential resources. Solar heating and (off-grid) solar PV electricity generation	Large-scale solar power stations under research and development	Average solar radiation per year 58 million PJ	7	0.1	0.1	-
Ocean (Wave and tidal)	Large undeveloped resources, demonstration projects in progress	Economic evaluation dependent on demonstration projects in progress	Average total tidal kinetic energy at any time on continental shelf – 2.42 PJ Average total wave energy at any time on continental shelf – 3.47 PJ	-	0.0008	-	-
Bioenergy	Significant under-utilised resources, potential new resources	Commercial production of electricity and heat from bagasse, biogas and other biomass. Commercial production of biofuels	Bagasse, wood waste, sewage gas, land-fill gas, forest and agricultural residues, and energy crops	226	0.9	2.2	-
				Biofuels 199 ML	-	-	-

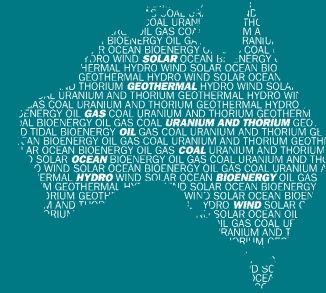
**a** Recoverable at <US\$ 80/kg. **b** A conversion into energy content equivalent for thorium was not available at the time of publication. **c** Total identified geothermal energy resources potentially available (including inferred resources), actual amount available depends on efficiency of extraction. **d** 2006–07 production. **e** World Energy Council, 2007, Survey of Energy Resources 2007

**Note:** Economic and total demonstrated resources for fossil fuels, uranium, thorium and geothermal based on McKelvey resource classification; not applied to renewable energy sources other than geothermal. Total resources are in many cases significantly larger than the remaining demonstrated resources which do not include inferred and potential (yet to be discovered) resources.

**Source:** Geoscience Australia; ABARE 2009, Australian Energy Statistics

# Chapter 2

## Australia's Energy Resources and Market



### 2.1 Summary

#### KEY MESSAGES

- Australia has a large, diverse energy resource base (including fossil fuels, energy minerals and renewables) that supports domestic consumption and exports to many countries.
- Australia's very large low-cost coal resources underpin cheap reliable electricity and exports of thermal and metallurgical coal. Australia exports uranium from its substantial resource base, and gas is used domestically and increasingly exported as LNG. However, Australia has only limited crude oil resources and is increasingly reliant on imports for its transport fuels.
- Australia has significant and widely distributed wind, solar, geothermal, ocean energy and bioenergy sources which, with the exception of wind which is now being rapidly exploited, are largely undeveloped. Hydro resources are largely developed.
- Australia's energy resource base could increase further over the next two decades as more resources are discovered and technology to harness and economically use energy improves.
- Demand for Australian energy resources continues to rise, both domestically and for export. However, the energy intensity of the Australian economy is expected to continue to fall over the period to 2030 through further efficiency gains and other adjustments.
- The role of renewable energy is likely to increase significantly, reflecting government policies such as the Renewable Energy Target, the Clean Energy Initiative (which includes the Carbon Capture and Storage and Solar Flagship Programs, and the Australian Centre for Renewable Energy), and the proposed emissions reduction target. Advances in renewable energy technologies will also be important.
- Significant investment in energy resources and infrastructure will be required over the next two decades to meet Australia's domestic and export market needs.

#### 2.1.1 Australia in the world energy market

- Australia is the world's twentieth largest consumer of energy, and fifteenth in terms of per capita energy use.
- Australia's large resource endowment and comparative advantages enable it to play an important role in supplying the rest of the world with its energy needs.
- Australia is currently the world's largest exporter of coal, one of the largest uranium exporters, and is ranked sixth in terms of liquefied natural gas (LNG) exports.
- Australia holds an estimated 38 per cent of world uranium resources, 9 per cent of world coal resources, and 2 per cent of world natural gas resources.
- Australia also has substantial renewable energy resources including solar, wind, wave, geothermal and bioenergy resources.
- Australia's energy fuel mix is dominated by coal, reflecting our large, low-cost resources. Our energy market therefore differs from those of many other Organisation for Economic Co-operation and Development (OECD) countries and the world energy market where coal is less significant and hydro and nuclear energy are significant contributors to the fuel mix.
- The penetration of gas in Australia is similar to that of the OECD and world average, as is that of wind and solar.
- In its 2009 *World Energy Outlook* reference scenario, the International Energy Agency (IEA) projects world primary energy demand to increase by 40 per cent between 2007 and 2030 (from around 502 960 petajoules (PJ) to around 702 920 PJ). This represents an average annual growth rate of 1.5 per cent.
- China and India are expected to account for more than half of the increase in world primary energy demand during this period, driven by continuing strong economic growth.
- More than three-quarters of the increase in primary energy demand in the reference scenario is projected to be for fossil fuels. Of the fossil fuels, coal is expected to be the fastest growing

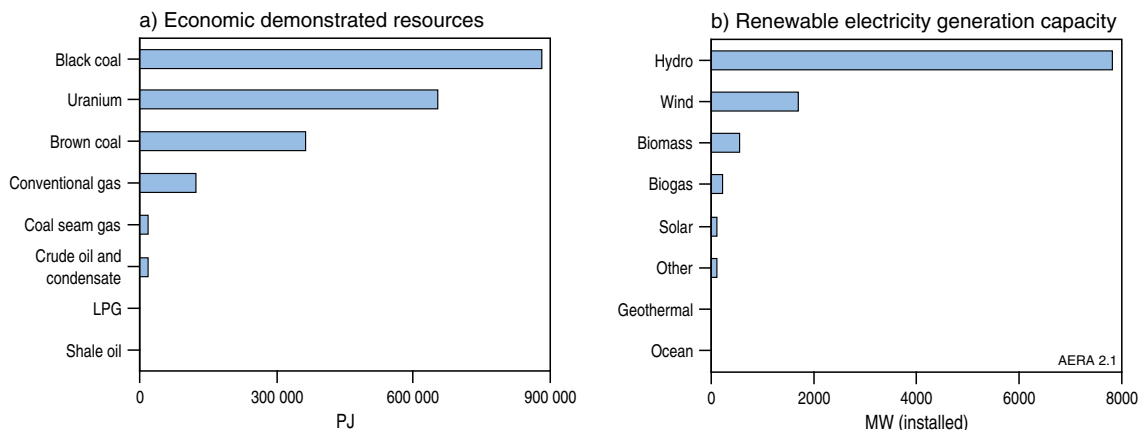
fuel, followed by gas. Coal is projected to account for 29 per cent of world primary energy demand in 2030, with gas maintaining its current share of 21 per cent.

- Renewable energy demand is also expected to rise rapidly, though from a much smaller base. Renewables are projected to account for 14 per cent of world primary energy demand in 2030. Wind will drive much of the growth in renewable energy, although demand for hydro, bioenergy and solar energy will also increase significantly.
- The IEA also presents projections for world energy demand if economies adopt emissions reduction policies to stabilise the concentration of greenhouse gas emissions in the atmosphere at 450 parts per million of carbon dioxide (CO<sub>2</sub>) equivalent.
- Under this 450 scenario, growth in world energy demand to 2030 is significantly constrained, projected to rise by only 20 per cent on current levels. The share of coal in the primary energy mix is projected to fall sharply to 18 per cent in 2030. In contrast, the share of renewable energy is projected to rise to 22 per cent in that year. This reflects the increased competitiveness of renewable technologies relative to coal with the introduction of carbon pricing.

### 2.1.2 Australia's energy resources and infrastructure

- Australia has abundant, high quality energy resources, widely distributed across the country. With the exception of oil, these resources are expected to last for many more decades, even as production increases.
- The fossil fuel resources available to Australia include coal (black and brown), gas (conventional, coal seam gas (CSG) and potentially tight gas) and oil (crude oil, liquefied petroleum gas (LPG), condensate and shale oil).

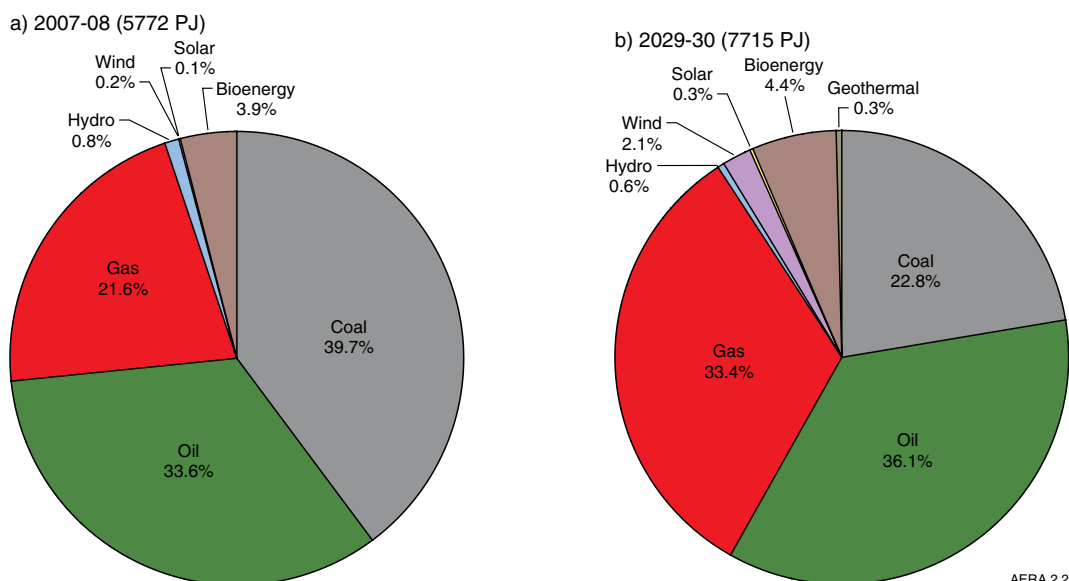
- However, Australia has only limited domestic supplies of crude oil, and relies increasingly on imports to meet demand.
- As of December 2008, Australia's economic demonstrated resources (EDR) of coal were estimated to be 1.25 million PJ, of which black coal are 883 400 PJ (figure 2.1a). Conventional gas EDR were estimated to be 122 100 PJ, and coal seam gas 16 590 PJ. Crude oil EDR are estimated to be 6950 PJ, condensate 12 560 PJ and LPG 4610 PJ.
- Australia also has extensive uranium and thorium resources. Australia's reasonably assured resources of uranium recoverable at less than US\$80/kg (equivalent to EDR) are estimated to be 651 280 PJ as of December 2008. Australia also has a major share of the world's thorium resources.
- Australia's potential renewable resource base is also very large. This includes some of the best solar resources in the world and significant (Hot Rock) geothermal energy potential, associated with buried radiogenic granites.
- Australia's wind resources are also among the best in the world, primarily located in western, south-western, southern and south-eastern coastal regions but extending hundreds of kilometres inland. Australia also has a world-class wave energy potential along its south-western and southern coast.
- There is also significant potential to increase the importance of bioenergy in Australia through greater use of biomass and greater production of biofuels for use in transport.
- While hydro energy currently accounts for the major share of Australia's renewable electricity generation, water availability limits any significant expansion.



**Figure 2.1** Australia's energy resources in terms of economic demonstrated resources of non-renewable resources and installed renewable electricity generation capacity

Source: Geoscience Australia 2009a, b, c

- There are currently some impediments to large-scale utilisation of Australia's renewable resources, including the generally higher costs relative to other energy sources, their often remote location from markets and infrastructure, and the relative immaturity (except for hydro and wind) of many renewable technologies.
  - Most of Australia's installed renewable electricity generation capacity is hydro and wind energy (figure 2.1b). The next largest are bioenergy (biomass and biogas) and solar. Australia has significant geothermal and wave energy resources but these industries are currently at pilot and demonstration stage and not yet commercial.
  - Energy infrastructure is concentrated in areas where energy consumption is highest and major energy resources are located, particularly along the eastern seaboard of Australia.
  - A significant expansion in Australia's energy infrastructure – particularly electricity generation and transmission – will be required in the next two decades if Australia is to meet its demand for energy. Utilising new energy resources, particularly renewable energy sources, will require a more flexible and decentralised electricity grid.
- ### 2.1.3 Australia's energy market to 2030
- The energy sector plays an important role in Australia's economy. It accounts for around 5 per cent of industry gross value added, and 20 per cent of total export value. It also provides significant employment and infrastructure, and supports a range of manufacturing industries.
  - Australia's energy production was 17 360 PJ in 2007–08. The main energy sources produced, on an energy content basis, are coal (54 per cent), uranium (27 per cent) and gas (11 per cent). Renewable energy accounts for nearly 2 per cent of total production.
  - Primary energy consumption was 5772 PJ in 2007–08. Coal accounts for around 40 per cent of this total, followed by oil (34 per cent) and gas (22 per cent) (figure 2.2a). Renewable energy accounts for 5 per cent of primary energy consumption, most of which is bioenergy. Wind and solar account for only 0.3 per cent of primary energy consumption.
  - Total electricity production was around 925 PJ (257 TWh) in 2007–08. Coal accounts for more than three-quarters of Australia's electricity generation, followed by gas (16 per cent). Renewables account for an estimated 7 per cent of electricity generation, most of which is hydro.
  - Australia exports more than three-quarters of its energy production, with exports of 13 559 PJ in 2007–08, at a value of \$45.6 billion. In 2008–09, the value of energy exports increased to \$77.9 billion, supported by higher world prices.
  - Coal accounted for more than half of exports on an energy content basis, followed by uranium (35 per cent). In contrast, Australia imports more than three-quarters of its oil requirements.
  - Major changes are anticipated in the Australian energy market over the next two decades, reflecting new policy initiatives, including the expanded Renewable Energy Target (RET) and a proposed emissions reduction target.
  - Other factors expected to affect the market include the rate of economic and population



**Figure 2.2** Australia's primary energy consumption, 2007–08 and 2029–30

Source: ABARE 2009a, 2010a. See box 2.2 for further details on sources

growth, energy prices, and costs and developments in alternative energy technologies.

- Technology is expected to play a critical role in the transition to a low emissions economy. This includes the development and commercialisation of new technology to improve efficiency in the extraction and use of energy, facilitate the use of new fuel sources and reduce the emissions intensity of the sector.
- While Australia's energy demand is expected to rise over the period to 2030, the rate of growth is expected to continue to slow. This is partly because of expected energy efficiency improvements, but more importantly because of the response to climate change and higher energy prices. The contribution of gas and renewables is expected to increase significantly.
- ABARE's latest long-term Australian energy projections examine the effects of a 5 per cent emissions reduction target below 2000 levels by 2020, combined with the RET (20 per cent of electricity supply by 2020) and other existing policy measures, on Australia's energy market.
- Australia's total energy production is projected to increase by 3.2 per cent per year to reach around 35 057 PJ by 2029–30. The share of gas, uranium and renewables in total energy production is projected to increase. The share of coal is projected to fall, although coal production is still projected to increase as a result of strong export demand.
- Australia's primary energy consumption is projected to increase by 1.4 per cent per year to reach around 7715 PJ by 2029–30. The primary fuel mix is expected to change significantly (figure 2.2b). The share of coal is expected to decline to 23 per cent by 2029–30. In contrast, gas is expected to rise to 33 per cent and wind to 2 per cent. Renewable energy is projected to account for 8 per cent of Australian energy consumption by 2029–30.
- Electricity generation is projected to reach 366 TWh in 2029–30, an increase of 1.8 per cent per year. Coal is expected to continue to dominate the electricity fuel mix (43 per cent in 2029–30), but emission pricing will lead to a trend away from higher-emission energy sources towards gas (37 per cent) and renewables (19 per cent), particularly wind (12 per cent).
- Net energy trade is projected to increase by 3.9 per cent per year, to reach 27 342 PJ in 2029–30. Exports of coal, uranium and LNG are all expected to rise significantly, to meet growing world energy requirements. Net imports of liquid

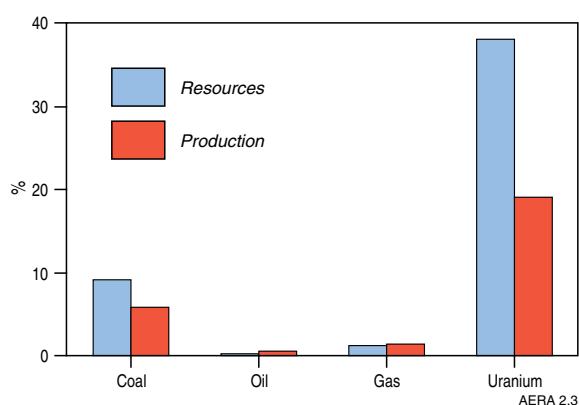
fuels are projected to increase at an average rate of 3.3 per cent per year, reflecting declining oil production.

## 2.2 Australia in the world energy market

Australia has a large and diverse energy resource endowment with comparative advantages that enable it to play an important role in supplying the rest of the world with its energy needs (figure 2.3). Australia is currently the world's largest coal and one of the largest uranium exporters, and is ranked sixth in terms of LNG exports.

Australia's energy market differs from a number of other OECD and world energy markets. Coal plays a much larger role in Australia's fuel mix, reflecting our large, low cost reserves. Nuclear and hydro power are significant contributors to the energy mix in a number of OECD countries. The penetration of gas in the Australian energy market is similar to that of the OECD and world average, which is also the case for wind and solar.

This section provides a brief overview of the world energy market and the role of Australia, as well as some comparisons between the Australian, OECD and world markets. It also summarises the latest outlook for the world energy market released by the IEA in November 2009. This outlook contains two scenarios: (1) a **reference scenario**, which is a business as usual scenario that predicts how global energy markets would evolve if governments made no changes to their existing policies and measures; and (2) a **450 scenario** which presents likely world energy markets predicated on countries taking collective policy action to limit the long-term concentration of greenhouse gases in the atmosphere to 450 parts per million of CO<sub>2</sub>-equivalent (IEA 2009b).



**Figure 2.3** Australia's share of world energy resources and production, 2008

**Source:** IEA 2009a; BP 2009



## 2.2.1 Current world market snapshot

### Resources and production

World energy resources are widely dispersed. Some countries are well endowed with a single or multiple energy resources, while others have limited indigenous energy resources and rely on imports to meet requirements.

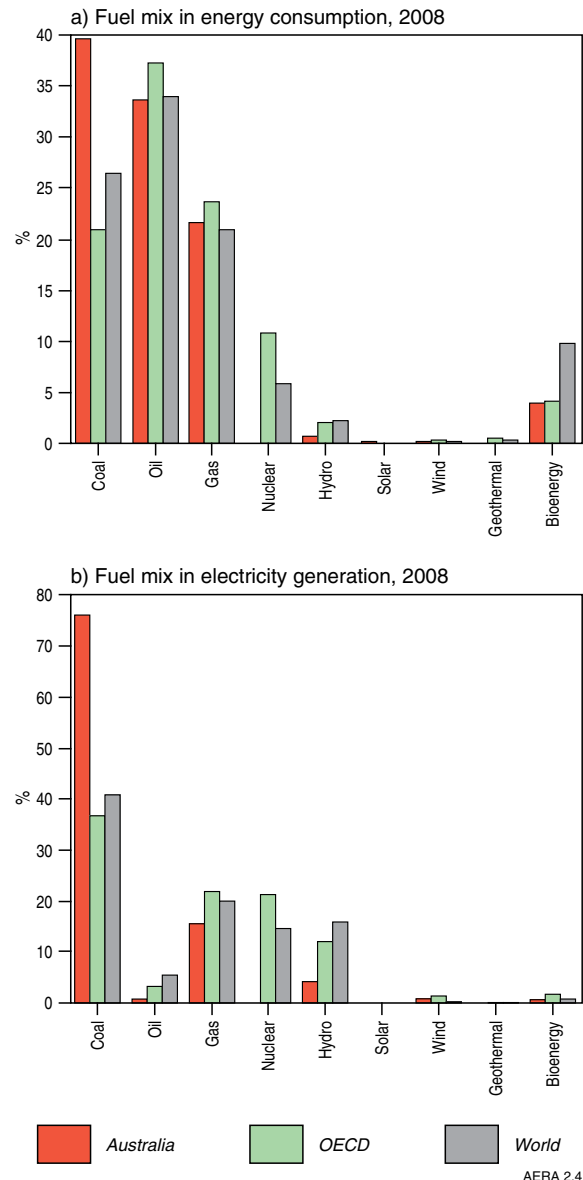
Large proved coal reserves are located in the United States, the Russian Federation, China and Australia. Significant proved crude oil reserves are located in Saudi Arabia, Iran, Iraq, Kuwait and the United Arab Emirates while most of the world's proved conventional gas reserves are in the Russian Federation, Iran and Qatar. Australia has the world's largest Reasonably Assured Resources (RAR) of uranium, followed by Kazakhstan and Canada.

Most countries have some potential for renewable energy resources, although these resources in some regions and countries are of higher quality and more readily accessible than in others. Asia, Africa and the Americas have the highest potential for hydroelectricity. Geothermal potential is generally greatest in countries located near chains of active volcanoes, however, technological improvements have made it possible for most countries to use shallow low temperature geothermal resources. Solar potential is greatest in the Red Sea area, including Egypt and Saudi Arabia, while Australia and the United States also have above average potential. Locations with the highest wind energy potential include the coastal regions of western and southern Australia, New Zealand, southern South America, South Africa, northern and western Europe, and the north eastern and western coasts of Canada and the United States. Some of the coastlines with the greatest wave energy potential are the western and southern coasts of South America, South Africa and Australia.

In 2007, world energy production was around 499 880 PJ. The largest energy producers include China, the United States, the Russian Federation and Saudi Arabia. Australia is the world's ninth largest energy producer, accounting for 2.4 per cent of world energy production (IEA 2009a). Australia is the world's third largest producer of uranium, fourth largest producer of coal, and ranked nineteenth in the world for gas production.

### Primary energy consumption

World primary energy consumption increased by 2.6 per cent per year between 2000 and 2007. The United States (19 per cent), China (16 per cent), the Russian Federation (6 per cent), India (5 per cent) and Japan (4 per cent) are the largest energy users. Australia is the world's twentieth largest consumer of energy, and fifteenth in terms of per person energy use (IEA 2009a).



**Figure 2.4** Fuel mix in primary energy consumption and electricity generation, 2008

**Note:** Australian data are for 2007–08, world data are for 2007

**Source:** ABARE 2009a; IEA 2009a

Oil is the world's main energy source, currently accounting for around 34 per cent of total primary energy consumption, followed by coal (26 per cent) and gas with 21 per cent (figure 2.4a). This fuel mix has been relatively stable over the past decade. Nuclear accounts for 6 per cent of the primary energy mix. Renewables account for around 13 per cent of world energy consumption, most of which is bioenergy with much smaller contributions from hydro, geothermal and wind.

Coal plays a more significant role in Australia's energy mix than in other OECD and world energy markets. Australia's dependence on oil is similar to the world average, while the penetration of gas is similar to that of the OECD and world average, as is

that of wind and solar. The use of hydro energy and bioenergy is significantly lower in Australia than in the world energy market.

### Electricity generation

Gross electricity generation has increased by 3.7 per cent per year since 2000, to reach 19 771 TWh in 2007 (IEA 2009a).

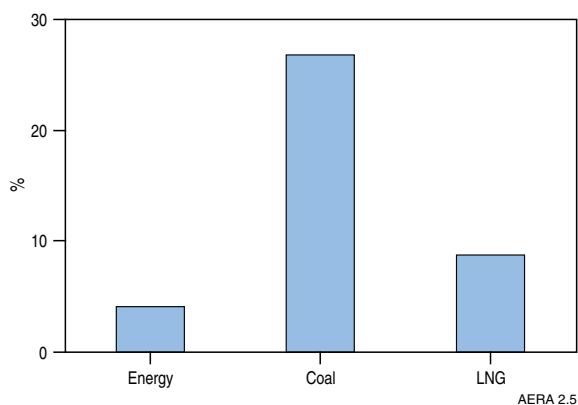
Coal and gas are also the largest sources of global electricity generation with 42 per cent and 21 per cent in 2007, respectively (figure 2.4b). Nuclear power comprises 14 per cent of world and 21 per cent of OECD electricity production. Renewables contribute around 18 per cent of electricity generation, most of which is hydro energy.

Australia relies more heavily on coal for electricity generation than the world and OECD averages, where the balance of base load power generation is largely made up by nuclear and hydro energy. The use of gas-fired electricity in Australia is slightly lower than the world and OECD average. However, the share of wind and solar in Australia is slightly higher than the world average.

### Trade

With a number of energy resources located long distances from major energy consumers, there has been considerable growth in world energy trade. World energy imports have increased by 3.2 per cent per year since 2000, to account for 39 per cent of primary energy consumption in 2007. The main energy exporters include the Russian Federation, Saudi Arabia and Canada (IEA 2009a).

Australia, with its rich resource endowment, plays an important role in supplying regional and global energy demand, particularly for coal and uranium, and increasingly natural gas (figure 2.5). Australia is the world's sixth largest energy exporter overall – Australia is the world's largest exporter of coal, one of the largest uranium exporters, and is ranked sixth in terms of LNG exports.



**Figure 2.5** Australia's share of world energy trade, 2008

**Source:** IEA 2009a. Note that the share of total energy trade is for 2007

## 2.2.2 World energy market outlook to 2030

### IEA reference scenario

In its 2009 *World Energy Outlook* reference scenario, that predicts how global energy markets would evolve if governments made no changes to their existing policies and measures, world primary energy demand is projected to increase by 40 per cent (from around 502 960 PJ to around 702 922 PJ) between 2007 and 2030 (IEA 2009b; table 2.1). This represents an average annual growth rate of 1.5 per cent, with the majority of this increase expected to be driven by non-OECD countries.

China and India are expected to account for more than half of the increase in world primary energy demand during this period, driven by continuing strong economic growth. Energy demand in the Middle East is also projected to grow strongly over this period.

Global demand for coal is expected to grow by an average of 1.9 per cent per year between 2007 and 2030, with its share of global energy demand increasing from 27 per cent in 2007 to 29 per cent in 2030 (figure 2.6). The majority of this increase in world coal demand is expected to come from China and India. China is also projected to account for nearly two-thirds of the increase in global coal production over the period. The United States, India and Australia are expected to remain the next largest coal producers.

World demand for gas is projected to grow at an annual average rate of 1.5 per cent during the outlook period, with its share of world energy use to remain at 21 per cent in 2030. More than 80 per cent of the increase in demand is projected to be from non-OECD countries, particularly the Middle East. The Middle East and Africa are expected to account for the largest increases in natural gas production over the period to 2030. The share of production worldwide from unconventional gas sources is projected to expand from 12 per cent in 2007 to almost 15 per cent in 2030. The share of LNG in world gas trade is also expected to rise, from around 34 per cent in 2007 to 40 per cent in 2030.

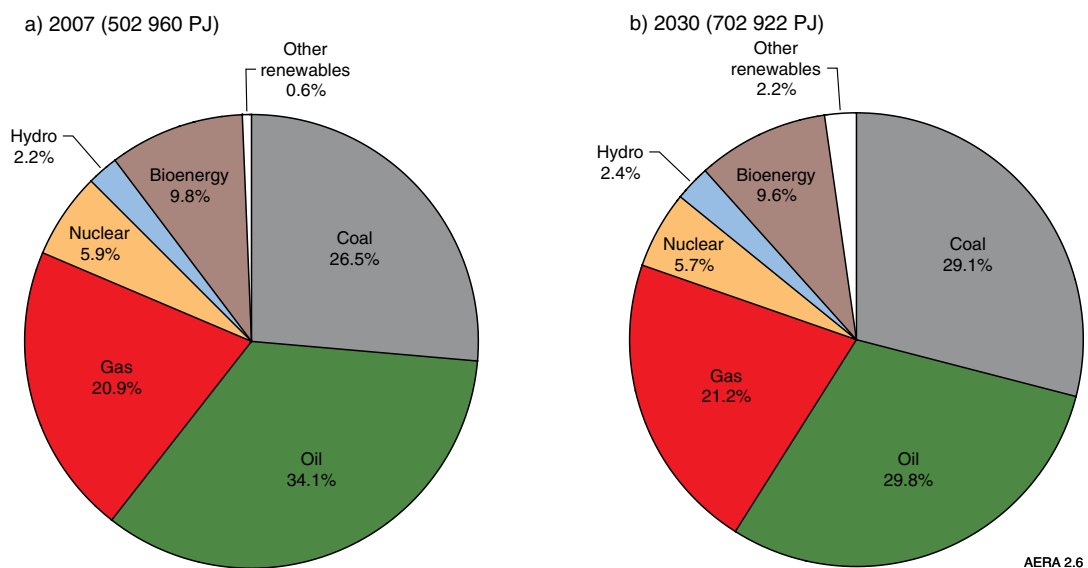
The IEA forecasts that the rise in unconventional gas production, together with slower demand growth in the medium term, will contribute to a glut of gas supplies in the next few years. This has implications for prices, as well as energy trade. For instance, the increasing role of unconventional gas production in the United States – to more than half of total production – is reducing its reliance on imports, particularly of LNG.



**Table 2.1** Outlook for world primary energy demand, IEA reference scenario

	2007	2030	2007	2030	Average annual growth 2007–2030
	PJ	PJ	%	%	%
Coal	133 308	204 609	26.5	29.1	1.9
Oil	171 366	209 717	34.1	29.8	0.9
Gas	105 172	149 092	20.9	21.2	1.5
Nuclear	29 684	40 026	5.9	5.7	1.3
Hydro	11 095	16 831	2.2	2.4	1.8
Bioenergy	49 237	67 156	9.8	9.6	1.4
Other renewables	3098	15 491	0.6	2.2	7.3
Total	502 960	702 922	100.0	100.0	1.5

Source: IEA 2009b

**Figure 2.6** Outlook for world primary energy demand, IEA reference scenario

Source: IEA 2009b

Global demand for oil is projected to grow by 0.9 per cent per year on average to 2030. Oil is expected to continue to dominate the primary fuel mix, but its share of world energy use is expected to decline from 34 per cent in 2007 to 30 per cent in 2030. Around 42 per cent of the global increase in oil demand is expected to come from China, followed by the Middle East and India. Most of the increase in oil production over the period is projected to come from OPEC countries (mainly in the Middle East). The OPEC share in total oil production is projected to increase from an estimated 44 per cent in 2008 to 52 per cent in 2030.

From 2007 to 2030, the share of nuclear power in primary energy demand is projected to remain steady at 6 per cent, with demand to increase by 1.3 per cent per year over this period. Most of the projected growth in nuclear power is expected to be in China, with most of the remaining growth occurring in other

Asian countries. Nuclear power capacity in Europe, however, is projected to decline over the outlook period. Australia is expected to remain a key provider of uranium exports to the growing Asian markets.

Globally, renewable technologies are expected to grow faster than any other energy source between 2007 and 2030, but from a smaller base. Excluding bioenergy and hydro, renewable energy sources such as wind, solar, geothermal and wave and tidal energies are projected to grow at an annual average rate of 7.3 per cent. The share of these renewables in total primary energy demand is also expected to increase from 0.6 per cent in 2007 to 2.2 per cent in 2030.

World demand for hydro is forecast to grow at an average annual rate of 1.8 per cent between 2007 and 2030, with its share of world energy demand remaining constant at 2 per cent. The use of

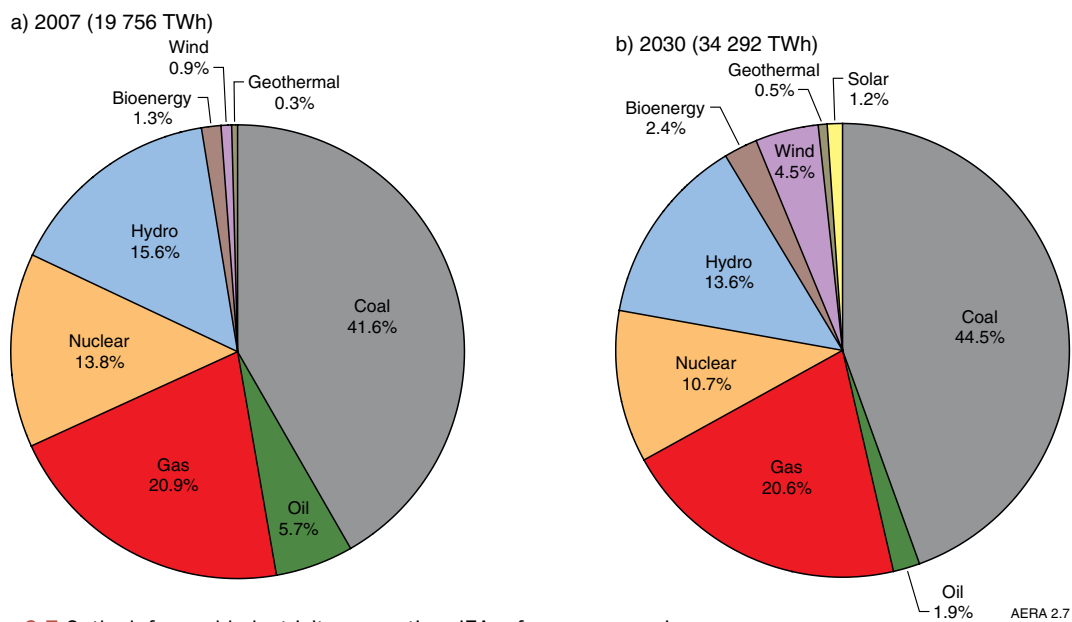
bioenergy is expected to increase by 1.4 per cent per year on average during the outlook period, with its share to remain at just under 10 per cent of primary energy demand.

World electricity generation is projected to increase by 2.4 per cent per year, to reach 34 292 TWh by 2030 (table 2.2). The share of coal-fired electricity is projected to rise to 44 per cent in 2030 (figure 2.7). Other fuels expected to increase their share of electricity generation by 2030 include wind (to 4.5 per cent), bioenergy (to 2.4 per cent), solar (to 1.2 per cent), and geothermal (to 0.5 per cent). In contrast, the shares of oil, nuclear and hydro in world electricity generation are expected to fall.

### IEA 450 scenario

In its latest *World Energy Outlook* (IEA 2009b), the IEA also presents projections for world energy demand if economies adopt emissions reduction policies to stabilise the concentration of greenhouse gas emissions in the atmosphere at 450 parts per million of CO<sub>2</sub>-equivalent.

Under this 450 scenario, projected growth in world energy demand to 2030 is significantly constrained, rising by only 20 per cent on current levels to reach 602 481 PJ in 2030 (around 100 441 PJ lower than in the reference scenario). This is equal to average annual growth of around 0.8 per cent.



**Figure 2.7** Outlook for world electricity generation, IEA reference scenario

Source: IEA 2009b

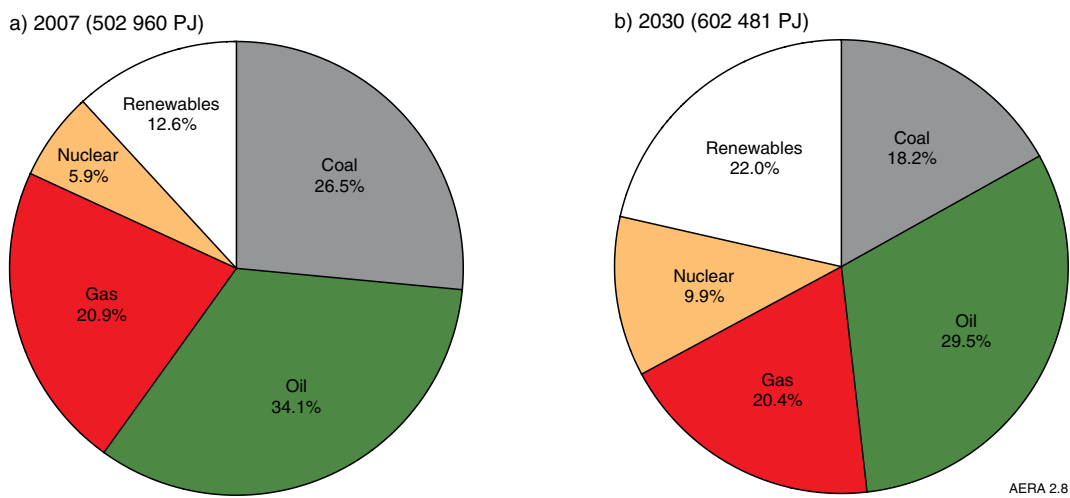
**Table 2.2** Outlook for world electricity generation, IEA reference scenario

	2007	2030	2007	2030	Average annual growth 2007–2030
	TWh	TWh	%	%	%
Coal	8216	15 259	41.6	44.5	2.7
Oil	1117	665	5.7	1.9	-2.2
Gas	4126	7058	20.9	20.6	2.4
Nuclear	2719	3667	13.8	10.7	1.3
Hydro	3078	4680	15.6	13.6	1.8
Bioenergy	259	839	1.3	2.4	5.2
Wind	173	1535	0.9	4.5	9.9
Geothermal	62	173	0.3	0.5	4.6
Solar	5	402	0.0	1.2	21.2
Tide and wave	1	13	0.0	0.0	14.6
<b>Total</b>	<b>19 756</b>	<b>34 292</b>	<b>100.0</b>	<b>100.0</b>	<b>2.4</b>

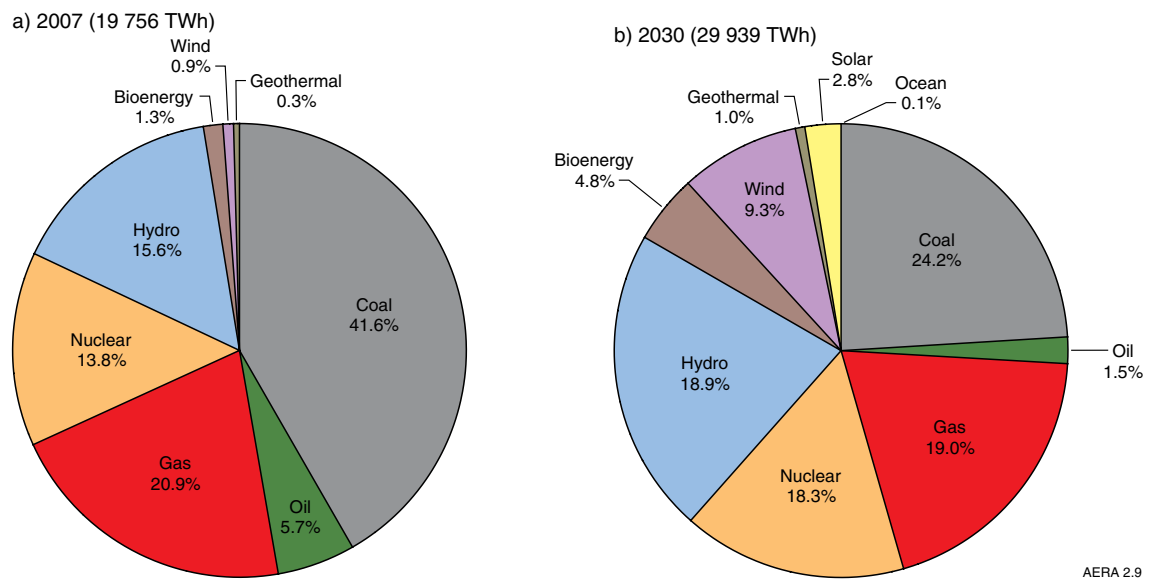
Source: IEA 2009b

The fuel mix in primary energy demand is expected to be significantly different than that of today and in 2030 under the IEA reference scenario. The share of coal is expected to fall sharply to 18 per cent in 2030, as coal demand contracts by 0.9 per cent per year (figure 2.8). The share of gas is projected to remain fairly steady at around 20 per cent, with demand to increase by 0.7 per cent per year to 2030. This means that measures to encourage low carbon technologies such as renewables, as well as overall energy efficiencies, more than offset the effect on demand of the enhanced competitiveness of gas relative to coal and oil. The share of renewables is projected to rise sharply to 22 per cent by 2030.

The share of coal in total electricity generation is also projected to fall sharply in the 450 scenario to 24 per cent in 2030 (figure 2.9). As with primary energy, the share of gas in 2030 is projected to be similar to current levels. Nuclear power also increases its share of electricity generation significantly, to 18 per cent in 2030. All renewables expand their role in electricity generation under a 450 scenario, reflecting favourable government policies and an enhanced competitiveness against fossil fuels under carbon pricing. The strongest growth is expected in wind and solar, with geothermal also rising relatively quickly (IEA 2009b).



**Figure 2.8** Outlook for world primary energy demand, IEA 450 scenario  
 Source: IEA 2009b



**Figure 2.9** Outlook for world electricity generation, IEA 450 scenario  
 Source: IEA 2009b

## 2.3 Australia's energy resources and infrastructure

Australia has abundant, high quality energy resources, widely distributed across the country. With the exception of oil, these resources are expected to last for many more decades, even as production increases. Australia has a significant proportion of the world's uranium and coal resources and large resources of conventional and unconventional gas. Australia also has access to a range of high quality, abundant renewable energy sources, many of which are yet to be developed. This section provides an overview of the size and distribution of Australia's energy resources and related infrastructure. More detailed information on specific resources is contained in the individual resource chapters.

### 2.3.1 Australia's energy resource base

#### Non-renewables

Australia's non-renewable energy resources include the fossil fuels – coal, gas and oil – and the nuclear energy fuels uranium and potentially thorium.

Table 2.3 provides a summary of current resource estimates, while figure 2.10 shows their distribution.

Australia's coal resources are world class in magnitude and quality. Australia's economic demonstrated resources (EDR) of black and brown coal are estimated to be 1.25 million PJ (76.4 billion or gigatonnes, Gt) as of December 2008 (chapter 5). Black coal EDR are estimated to be 883 400 PJ (39.2 Gt). This is equal to around 90 years remaining at current rates of production. Resources of black coal are distributed in most states, with the largest resources located in the Bowen-Surat and Sydney

**Table 2.3** Australian non-renewable energy resources, December 2008

Resource	Unit	Economic demonstrated resources	Total demonstrated resources <sup>a</sup>	Resource life at current production rates (years)
Black coal	PJ	883 400	1 046 500	
	TWh	245 400	290 695	
Uranium <sup>b</sup>	Mt	39 200	47 500	90
	PJ	651 280	660 240	
	TWh	180 900	183 401	
Brown coal	kt	1163	1179	140
	PJ	362 000	896 300	
	TWh	100 560	248 974	
Conventional gas	Mt	37 200	92 300	490
	PJ	122 100	180 400	
	TWh	33 920	5111	
Coal seam gas	tcf	111	164	63
	PJ	16 590	46 590	
	TWh	4490	12 970	
Condensate	tcf	15	42	100
	PJ	12 560	16 170	
	TWh	3490	4492	
Crude oil	mmbbl	2136	2750	31
	PJ	6950	8414	
	TWh	1930	2337	
LPG	mmbbl	1182	1431	10
	PJ	4614	6210	
	TWh	1280	1725	
Shale oil	mmbbl	1096	1475	20
	PJ	-	84 600	
	TWh	-	23 500	
Thorium <sup>b</sup>	mmbbl	-	14 387	-
	PJ <sup>c</sup>	-	-	-
	kt	-	76	-

**a** Includes economic and sub-economic demonstrated resources. **b** Recoverable at <US\$ 80/kg. **c** A conversion into energy content equivalent for thorium was not available at the time of publication

**Source:** Geoscience Australia

basins in Queensland and New South Wales, respectively. Australia has similar sized resources of brown coal, although these are much lower in energy content terms. Brown coal EDR are estimated to be 362 000 PJ (37.2 Gt), and are located mostly in Victoria. At current rates of production, there are nearly 500 years of brown coal resources remaining. In addition to the large EDR of coal Australia has even larger coal resources in the sub-economic and inferred categories. The true size of Australia's coal resources could be even larger as potential coal resources have not yet been fully assessed because the existing identified resource base is so large.

Australia also has significant resources of gas. These include the substantial conventional gas resources located mostly off the northwest coast of Western Australia and the CSG resources of eastern Australia (chapter 4). Conventional gas EDR are estimated to be 122 100 PJ (111 trillion cubic feet, tcf) as of

December 2008. This is equal to around 60 years at current rates of production. The EDR estimate does not include some significant recent discoveries that are yet to be proven economic and hence total identified gas resources are significantly larger. These are expected to grow with further exploration, even as production increases. CSG EDR are estimated to be 16 590 PJ (15 tcf), with substantial inferred resources of 122 020 PJ (111 tcf). CSG exploration in Australia is relatively immature, and high levels of current exploration are likely to add significantly to known resources. There are also tight gas resources held in low permeability sandstone reservoirs in several basins although these are not yet well defined.

Australia's liquid hydrocarbon resources include crude oil, as well as condensate and LPG resources associated with gas (chapter 3). Australia also has significant oil shale resources that could provide additional liquid fuels if developed. Crude oil EDR

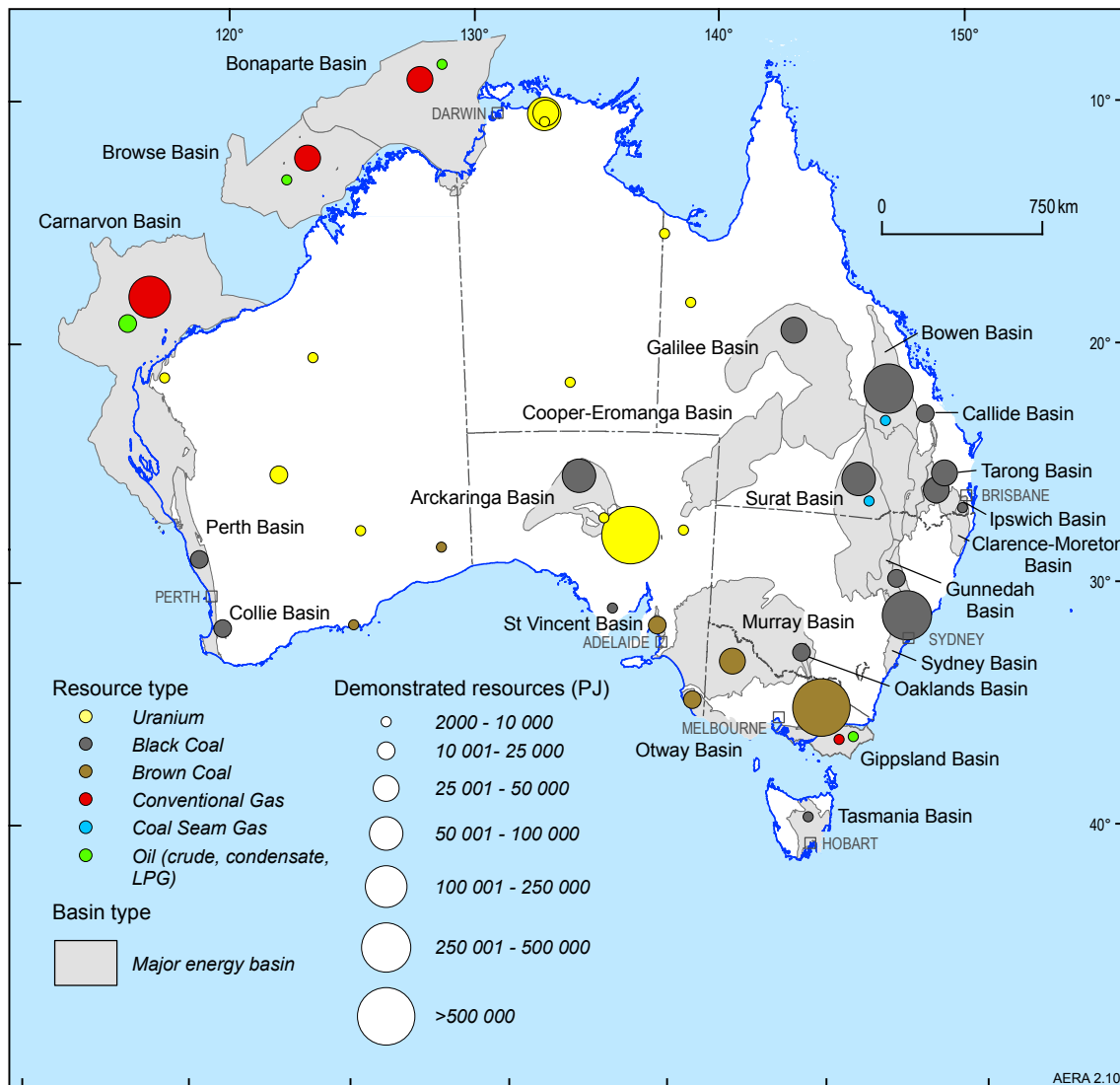


Figure 2.10 Distribution of Australia's major (containing more than 2000 PJ) non-renewable energy resources

Note: Major energy basins outlined in grey. Demonstrated resources include EDR and SDR. Total resources are in many cases significantly larger than the remaining demonstrated resources which do not include inferred and potential (yet to be discovered) resources.

Source: Geoscience Australia

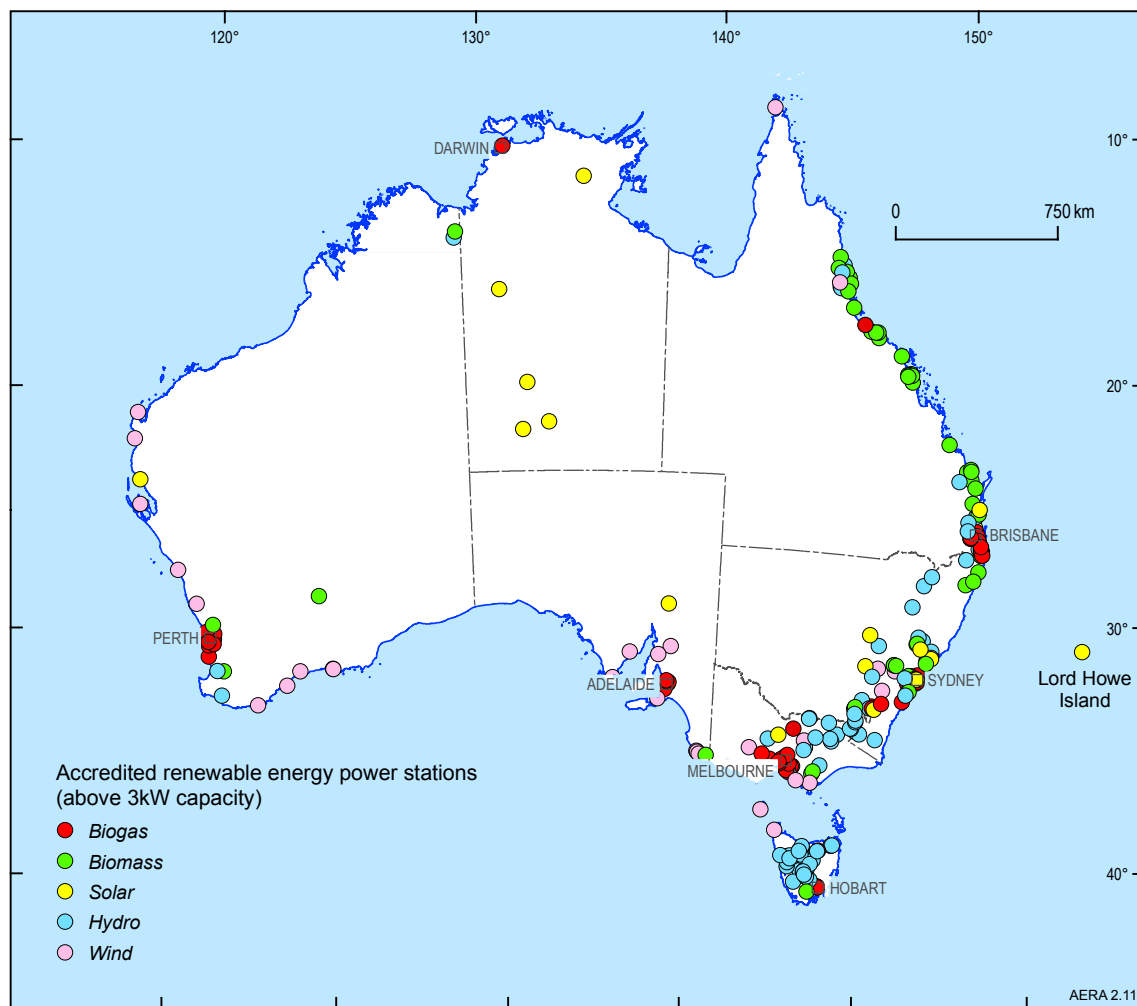
are estimated to be 6950 PJ (1182 million barrels, mmbbl) as of December 2008. This is equal to around 10 years at current rates of production. Australia's crude oil resources are only small by world standards and are being depleted at a faster rate than they are being replenished by discovery. As a result, Australia's domestic production of oil is declining, and Australia increasingly relies on imports to meet requirements. However, the oil potential of Australia's frontier basins has not been adequately assessed to date, and further exploration may yield additional resources. Australia also has more substantial liquid hydrocarbon resources in condensate (EDR of 12 560 PJ, 2136 mmbbl) and LPG resources (4614 PJ, 1096 mmbbl), but access to these depends on the development of the associated gas resources.

More than one third of the world's known economic uranium resources are located in Australia (chapter 6). Australia's reasonably assured resources of uranium recoverable at less than US\$80/kg (equivalent to EDR) are estimated to be 651 280 PJ (1163 kt) as of December 2008. The estimated accessible

uranium resources will last about 140 years at current production rates. Major uranium deposits are located in South Australia, the Northern Territory and Western Australia. Australia also has a major share of the world's thorium resources. While not currently in use as an energy resource, thorium could play a role in the long term as an alternative to uranium as a nuclear fuel. Given there is no active exploration for thorium, resource estimates are uncertain.

### Renewables

Australia's potential renewable resource base is also very large and widely distributed across the country (figure 2.11). However, there are significant constraints on large-scale utilisation of Australia's renewable resources in the immediate future. At present, these generally have higher transformation costs relative to other energy sources (except for hydro), many are often long distances from markets and infrastructure, and the technologies to utilise these resources are commonly immature. To date, this has limited the uptake of renewable energy in Australia, although its use is growing rapidly. Wind is the exception: wind technology is mature and



**Figure 2.11** Distribution of Australia's accredited renewable energy power station sites, above 3 kW capacity

**Source:** Geoscience Australia for the Office of the Renewable Energy Regulator



wind energy is the fastest growing renewable energy source in Australia. Expanded government support for renewable energy sources is expected to underpin a significant expansion in their use for electricity generation over the coming decades. Government support for renewables is discussed further in section 2.4.1.

Renewable energy resources are usually transient and not always available, and hence not readily classifiable and comparable to non-renewable resources. Renewable resources are often reported in terms of installed capacity. Installed capacity for renewables in Australia is provided in table 2.4. Estimates of potential renewable resources can also be made based on maps that show the energy potentially or theoretically available at a site and detailed studies of the annual and diurnal variation in the energy to determine the capacity factor. This is the average actual energy output compared with the theoretical maximum possible output if the energy was continuously and fully available for use.

Australia has very large but as yet inadequately defined and quantified geothermal energy resources that are the subject of active exploration (chapter 7). In particular, Australia has significant Hot Rock geothermal resources that could be used to produce super-heated water or steam suitable for base load electricity generation by artificially circulating fluid through the rock. There are also lower temperature geothermal resources present in deep aquifers in a number of sedimentary basins that are potentially suitable for electricity generation or direct use. Identified geothermal resources as of July 2009 are estimated at around 2.6 million PJ. The potential offered by geothermal energy for electricity generation is only now being examined in Australia. Electricity generation from geothermal energy in Australia is currently limited to one pilot power plant in south west Queensland producing 80 kW. There

are also a number of small direct use applications of geothermal energy resources. Several pilot projects are expected to be advanced within the next few years.

Hydro power was developed early in Australia, particularly in south-eastern Australia (chapter 8). As of September 2009, Australia had 108 operating hydroelectric power stations with total installed capacity of 7806 MW. These coincide with the areas of highest rainfall and elevation and are mostly in New South Wales and Tasmania. However, a dry climate coupled with a low run off over much of Australia limits substantial expansion of hydro power.

Australia has some of the best wind resources in the world, primarily located in western, south-western, southern and south-eastern coastal regions but extending hundreds of kilometres inland and including highland areas in south-eastern Australia (chapter 9). Wind energy technology is relatively mature, and its uptake is growing quickly in Australia, supported by government policies. As of September 2009, there were 85 wind farms in Australia with a combined installed capacity of 1703 MW.

Solar power is a vast potential source of energy (chapter 10). The Australian continent has the highest solar radiation per square metre of any continent in the world. The annual solar radiation falling on Australia is approximately 58 million PJ. The best solar resources are largely located in the northwest and centre of Australia, commonly in areas that do not have access to the electricity grid, and are distant from the major population centres and key energy markets. However, some of these high quality resources are close to new and emerging demand centres such as the Pilbara region. There are also significant and adequate solar energy resources in areas with access to the electricity grid and close to the major demand centres. To date relatively high capital costs have limited widespread use of solar energy resources. The total installed PV capacity in Australia is estimated to have been 105 MW at the end of 2008. Significant global investment in research and development (R&D) is aimed at increasing the efficiency and cost-effectiveness of solar power, including the development of solar thermal power stations.

There are also opportunities for ocean energy including mechanical energy from the tides and waves, and thermal energy from the sun's heat (ocean thermal) (chapter 11). The best tidal energy resources are located along the northern margin, especially the northwest coast of Western Australia, and largely removed from the major demand centres. Australia also has a world-class wave energy resource along its western and southern coastline, especially in Tasmania. Most ocean energy technologies are relatively new and still need to be proven in pilot and

**Table 2.4** Renewable electricity generation capacity in Australia, 2009

Resource	Capacity (MW)
Geothermal	0.1
Hydro	7806
Wind	1703
Solar	105
Ocean	1
Biogas	226
Bagasse	464
Wood waste	73
Other a	104
<b>Total</b>	<b>10 484</b>

a Other biomass and biodiesel

Source: Geoscience Australia 2009

demonstration plants. In Australia, four electricity generation units based on either tidal or wave energy have been developed as pilot or demonstration plants in recent years (totalling around 1 MW of generating capacity).

Bioenergy is another significant potential energy resource in Australia (chapter 12). Biomass (organic matter) can be used to generate electricity generation and heat, as well as for the production of liquid fuels for transport. Currently Australia's use of bioenergy for electricity generation is limited to bagasse (sugar cane residue), wood waste, and gas from landfill and sewage facilities. Biofuels for transport represent a small proportion of Australia's bioenergy: ethanol is produced from sugar by-products, waste starch from grain, and biodiesel is produced from used cooking oils, tallow from abattoirs and oilseeds. Commercialisation of second generation bioenergy technologies is likely to increase the range of resources, such as the non-edible (woody) parts of plants and potentially algae, available for both biofuels and electricity generation.

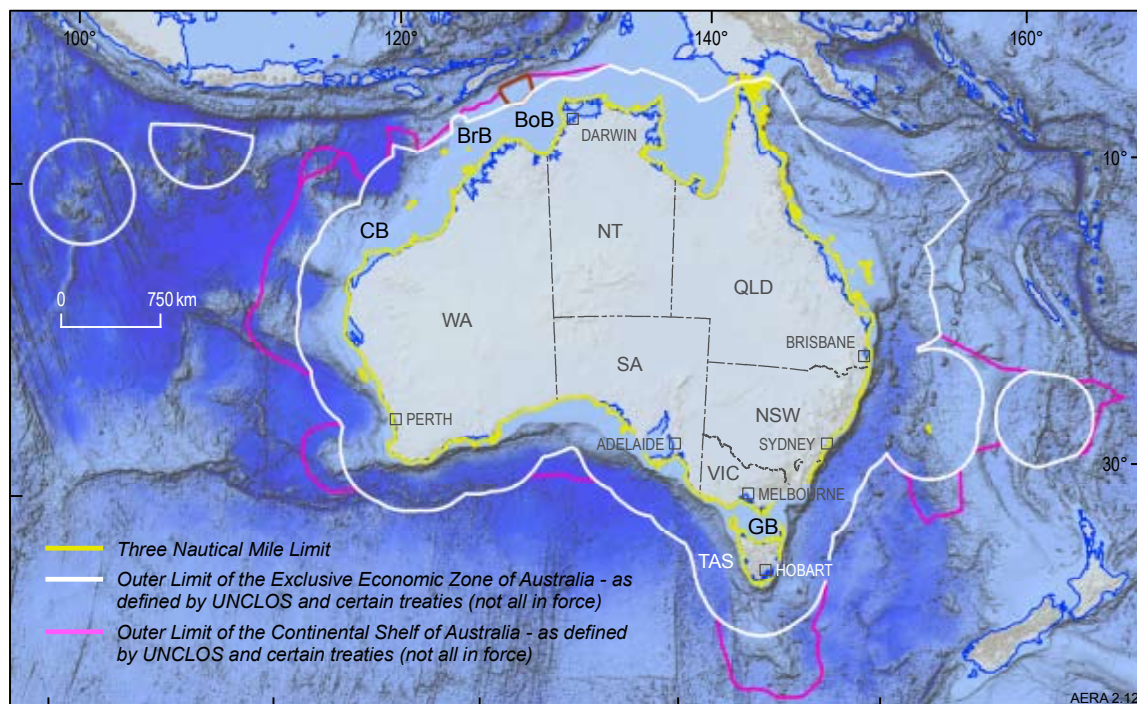
### 2.3.2 Distribution, ownership and administration of energy resources

Australia's energy resources are widely but not evenly distributed across Australia's states and territories. Certain regions within the States and the Northern Territory are highly endowed in particular energy (and other mineral) resources. Many of Australia's known and, potentially, undiscovered oil and gas

resources lie offshore within Australia's large marine jurisdiction. This has recently been increased to include large areas of continental shelf beyond 200 nautical miles, including exclusive rights to what exists on and under the seabed, including oil, gas and biological resources.

Under the Australian Constitution mineral and petroleum resources are owned either by the Australian or State/Territory governments. Exploration and development of these resources is undertaken by companies operating under licences and permits granted by government. Australian and State/Territory governments actively encourage investment in Australia's energy resources. Resources onshore and out to three nautical miles from the baseline of the territorial sea are the responsibility of the State and Territory governments. Responsibility for resources beyond three nautical miles – which extend to cover Australia's entire offshore jurisdiction – rests with the Australian Government and is administered through a Designated Authority/Joint Authority arrangement with the Australian and State/Northern Territory governments.

Exploration for and development of non-renewable resources is administered under the relevant State/Territory legislation relating to minerals and petroleum by State/Territory department or agency. The legislation varies between jurisdictions but is similar in content and administration, and based on a two-stage process of exploration permit and production licence.



**Figure 2.12** Australia's jurisdiction boundaries including the extent of Australia's marine jurisdiction and major offshore energy provinces

**Note:** CB – Carnarvon Basin, BrB – Browse Basin, BoB – Bonaparte Basin, GB – Gippsland Basin

**Source:** Geoscience Australia



The jurisdictions all allocate and manage mineral and petroleum property rights, have primary responsibility for land administration, regulate operations including environmental and occupational health and safety, and collect royalties on the resources produced. However, the minimum area, initial term of the permits, and charges and royalties levied vary between States and Territories. More information is provided in the *Mineral and Petroleum Exploration and Development in Australia: A Guide for Investors* ([www.ret.gov.au/resources/](http://www.ret.gov.au/resources/)) and from the State/Territory mineral and petroleum departments/agencies. The development of non-renewable resources is similarly governed by relevant State/Territory planning and development legislation and administered by designated departments and agencies charged with those functions.

Australia's large marine jurisdiction has recently been increased by more than 2.5 million km<sup>2</sup> of seabed by the United Nations Commission on the Limits of the Continental Shelf. The Commission confirmed the location of Australia's continental shelf outer limit in nine distinct marine regions, which entitles Australia to large areas of shelf beyond 200 nautical miles, including exclusive rights to what exists on and beneath the seabed, including oil, gas and biological resources.

Responsibility for the petroleum operations in Australian offshore areas beyond the first three nautical miles rests with the Australian Government, and is administered through a Designated Authority/Joint Authority arrangement with the Australian and State/Northern Territory governments under the *Offshore Petroleum and Greenhouse Gas Storage Act 2006*. An explanation of Australia's maritime zones is provided in *Australia's Offshore Jurisdiction* on the Department of Resources, Energy and Tourism (RET) website. Prospective acreage is released each year and exploration permits are awarded to companies through a work program bidding process. Retention leases and production, infrastructure and pipeline licences are granted for the recovery and transport of petroleum products. Further information is given at [www.ret.gov.au/resources/upstream\\_petroleum](http://www.ret.gov.au/resources/upstream_petroleum).

### 2.3.3 Energy infrastructure

Australia's existing energy infrastructure is designed to meet both domestic demand for energy and international demand for energy commodities (export markets). Infrastructure is concentrated in areas where energy consumption is highest and major energy resources are located. This tends to be in coastal regions where population is highest, particularly along the eastern seaboard. Australia's energy production facilities and transport infrastructure (including mines, power stations, rail, ports and pipelines) can be affected by climatic events such as intense precipitation, storms, bushfires, heat waves and floods. Any future expansion of Australia's energy market, including

access to new energy resources, will require investment in energy infrastructure, particularly electricity generation and transmission. Additional investment will be required not only to replace aging energy assets but also to allow for the integration of renewable energy into existing energy supply chains.

### Electricity

Australia has five electricity systems and numerous stand alone, remote electricity systems. The largest of these systems is the National Energy Market (NEM) in eastern Australia, followed by the south-west and north-west interconnected systems (SWIS and NWIS) in western Australia, and the Darwin-Katherine and Alice Springs systems in the Northern Territory. The NEM, established in 1998, allows power to flow across the Australian Capital Territory, New South Wales, Queensland, South Australia and Victoria, with Tasmania joining in 2005. This market is the foundation of Australia's electricity infrastructure, including transmission lines and generators (figure 2.13).

The NEM is linked by six major transmission interconnectors. The transmission and distribution network of the market consists of more than 779 900 km of overhead transmission and distribution lines, and more than 108 800 km of underground cables. There are also a number of projects under construction to expand the interconnector system. This interconnected electricity grid is the world's longest interconnected power system extending from Port Douglas (Queensland) to Port Lincoln (South Australia), a distance of nearly 5000 km (AEMO 2009). There is also a 290 km 400 kV direct current (DC) sea bed cable – the longest of its type in the world – that connects Loy Yang in Victoria with Bell Bay in Tasmania (the Basslink Interconnector) and allows trade of electricity between Tasmania and the mainland.

The various assets that comprise Australia's electricity infrastructure are owned and operated either by State/Territory governments or the private sector. Wholesale markets have been established for the dispatch and trade of electricity in the NEM and SWIS. Exchange between electricity producers and electricity consumers is facilitated through a pool where the output from all generators is aggregated and scheduled to meet demand through the use of information technology systems. These systems balance supply with demand, maintain reserve requirements, select which components of the power system operate at any one time, determine the spot price and facilitate the financial settlement of the market (AEMO 2009).

The grid connects and is relatively centralised around power stations at the fuel sources, especially the major coal resources and gas supply infrastructure, and the main electricity demand centres. As other resources are being utilised for power generation, including wind and coal seam gas, new nodes have been added. The

Australian Energy Regulator (AER) reports substantial new capital investment in the electricity network over the next five years with almost \$33 billion of investment either approved or proposed (AER 2009).

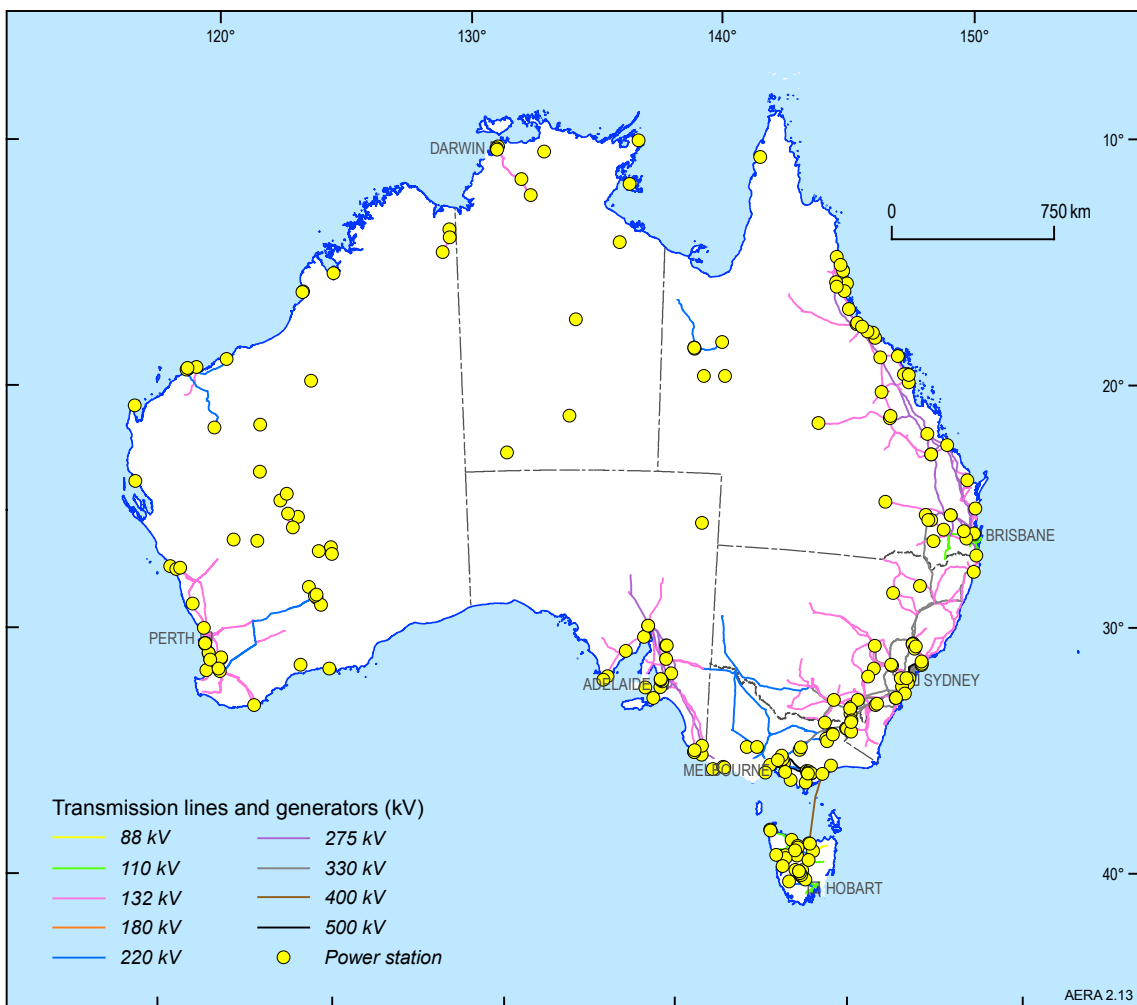
As part of a plan to improve network efficiency the Council of Australian Governments (COAG) has committed to and commenced the roll-out of smart meters to enable better manage demand on the network. The Australian Government has committed \$100 million to trial smart grid technologies that enable better control of (peak) load, and integration of embedded generation capacity, and provide better detection and avoidance of faults and disruptions on the network. Implementation of smart grid technologies could facilitate greater use of distributed energy generation with potential for increased energy fuel efficiency, reduced transmissions losses, and improved power quality at limited additional costs (CSIRO 2009).

The development of new sources of electricity, particularly renewables, will require further expansion of the grid and increased flexibility, particularly into

new areas not previously connected. A report by the Australian Energy Market Commission (AEMC 2009) acknowledged the impact of government policies (RET and emissions reduction targets) that will expand the role of renewable energy sources and recommended refinements to the existing energy market framework to better allow for greater access to renewable resources clustered in remote areas through development of connection 'hubs' or scale efficient network extensions. It also noted that expansion of gas-fired generation to back up renewable generation, such as wind, would lead to a greater demand for gas supply and pipeline infrastructure, and lead to a greater convergence of the gas and electricity markets.

### Ports

Australia has around 70 trading ports, a number of which are involved in exporting coal, oil, gas and uranium (Ports Australia 2009). There are nine major coal exporting terminals at seven ports in New South Wales and Queensland, 11 major deepwater ports with facilities to export petroleum liquids and two ports from which uranium is shipped (figure 2.14).



**Figure 2.13** Australia's electricity infrastructure

Source: Geoscience Australia

Infrastructure capacity constraints (including port and rail) have limited the Australian coal industry's ability to respond to growing global demand over the past few years. However, recent additions to capacity, together with more expansions planned over the short to medium term will help alleviate these constraints. As at October 2009, there were four port infrastructure projects in Queensland and New South Wales at an advanced stage of development, which will add a combined 103 million tonnes to annual capacity (ABARE 2009c).

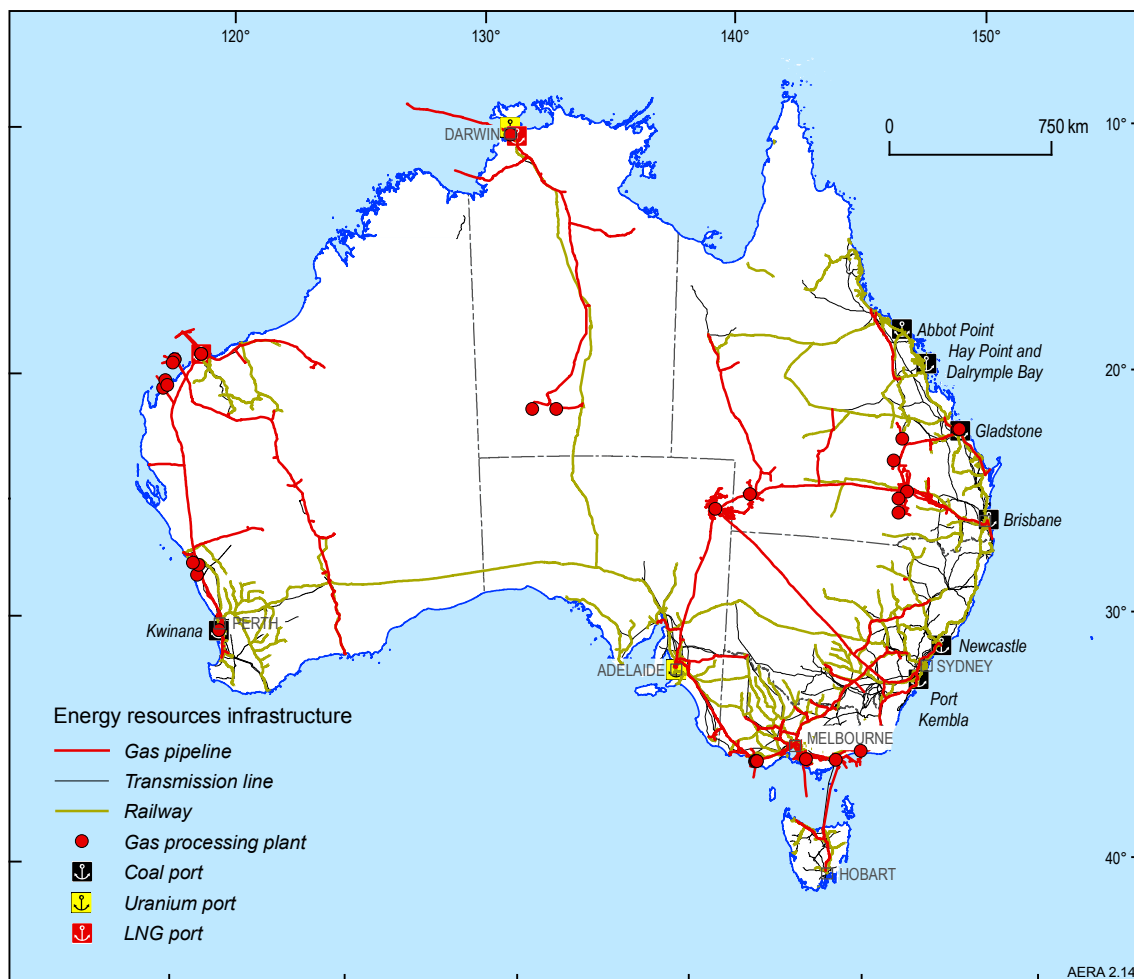
### Rail

Australia has substantial rail infrastructure. In New South Wales and Queensland, rail is used to transport coal from mines to loading ports. As of October 2009, a number of rail expansion projects were underway or planned in Queensland and New South Wales. Rail is also used to transport uranium to Adelaide and Darwin, the only ports open for uranium exports.

### Gas pipelines

Gas pipelines in Australia are focused around delivering gas (petroleum gas, natural gas and

coal seam gas) from where it is collected (gas and coal basins) or processed (gas or liquid processing facilities) to where it is consumed or exported. Major pipelines connect the conventional gas resources of the Cooper Basin and offshore Gippsland and Otway basins to the major population and industrial centres of the eastern seaboard (Brisbane, Sydney, Melbourne, and Adelaide) as well as Mount Isa. The coal seam gas production from the Bowen and Surat Basin also feeds into this network. The gas resources off the northwest coast of Western Australia are distributed to supply the mining and urban centres of Western Australia via the Dampier to Bunbury and Esperance pipelines. Another pipeline system connects gas resources in Amadeus and offshore Bonaparte basins to service the northern gas market (figure 2.14). There are currently more than 25 000 km of gas transmission pipelines in Australia (APIA 2009). The total length of Australia's gas distribution network is over 82 000 km and it delivers more than 370 PJ of gas a year (AER 2009). As of October 2009, further transmission capacity is under construction in Western Australia, Queensland, New South Wales, South Australia and Victoria



**Figure 2.14** Australia's energy resources infrastructure

**Source:** Geoscience Australia

(ABARE 2009c). Demand for further gas pipeline infrastructure is likely to increase as gas-fired peaking plants play an increasingly significant role in standby electricity generation in support of expanded electricity production from renewables such as wind.

## 2.4 Australia's energy market to 2030

Australia's energy market reflects its large and diverse resource base. Coal plays a dominant role in production, consumption and trade, while the contribution from gas and renewables continues to grow.

The energy sector is an important part of the Australian economy. Australia's energy production and exports have grown strongly over the past 30 years, especially in recent years in response to strong global demand for energy. The energy industries contributed around \$58 billion to industry gross value added in 2007–08, or around 5 per cent of the Australian total. Energy exports were valued at \$45.6 billion in 2007–08, which is around 20 per cent of Australia's total exports of goods and services. Energy exports were even higher in 2008–09, at around \$77.9 billion (ABARE 2009d). Australia's relatively low energy prices also support a large range of manufacturing industries. The energy sector also provides employment and significant infrastructure development in remote and regional areas.

This section examines the key factors that affect energy markets in Australia, such as economic and population growth, energy prices, government policy and technological development, as well as an overview of current Australian energy production, consumption and trade. It also contains ABARE's latest long term projections for the Australian energy market to 2029–30.

### 2.4.1 Energy market drivers

Demand for energy is driven by a range of factors, including the growth and structure of the economy, its stage of development, population and government policies. The choice of energy is based on prices, resource endowment, location and availability, available technologies, as well as government policies. Some of these key drivers are discussed in more detail below.

#### Economic growth and structure

Energy is an essential input into economic activity, and growth in the economy is one of the main drivers of increases in energy demand. Australia's real GDP has increased by 3.2 per cent per year since 1999–2000. In 2008–09, Australia's real GDP increased by 1.0 per cent, following growth of 3.7 per cent in 2007–08. This is largely as a result of the adverse effect of the global financial crisis on domestic demand and exports. As financial markets stabilise

and consumer and business confidence worldwide is restored, economic growth in Australia is expected to return to its longer term potential by 2010–11 and beyond. Between 2007–08 and 2029–30, Australian GDP growth is assumed to average 2.9 per cent per year (ABARE 2010a).

The Australian economy is also expected to continue to shift in terms of structure away from agriculture and industry toward the services sector. The services sector tends to use less energy per unit of output than manufacturing. This shift will continue to dampen the expected growth in energy demand over the next two decades.

#### Population growth

Population growth affects the size and pattern of energy demand. All else being equal, an increase in population requires an increase in energy use to support it. The Australian population is assumed to increase from 21.6 million in 2008 to reach 28.5 million by 2030 (ABS 2008, 2009).

#### Government policy

Government policies can affect both the pace of energy demand growth, and the type of energy used. Policies designed to enhance energy efficiency, for instance, would slow the pace of energy demand growth. Policies designed to enhance energy security may encourage diversity in the types of fuels used in an economy, or where the energy is sourced from. Policies to address environmental issues such as climate change may target a greater uptake of renewable energy technologies.

Two key government policies over the period to 2030 that will reshape the energy market are the Renewable Energy Target (RET) and a proposed carbon emissions reduction target.

In mid-2009, legislation for the expanded national RET was passed. The RET scheme is designed to ensure that 20 per cent of Australia's electricity supply comes from renewable sources by 2020. This will be achieved through an expansion of the previous Mandatory Renewable Energy Target (MRET) scheme, increasing the legislated national target from 9500 GWh to 45 850 GWh in 2020, in addition to what would have been generated without the policy. After 2020, the target will be maintained at 45 000 GWh until 2030, by which time it is expected that there will be a carbon price high enough to support renewable energy generation. The new targets took effect on 1 January 2010.

The aim of the RET scheme is to accelerate the uptake of renewable energy for on-grid power generation and to contribute to the development of internationally competitive renewable energy industries. It is also designed to bring existing state-based renewable energy targets into a single, national scheme.

**BOX 2.1 THE PROPOSED CARBON EMISSIONS REDUCTION TARGET**

The Australian Government released the White Paper on the Carbon Pollution Reduction Scheme (CPRS) on 15 December 2008 (Australian Government 2008). This document sets out the Government's policy for two components of its carbon mitigation strategy – the establishment of a medium term target range for emissions reduction and the final design of the emissions reduction target. The White Paper allowed for two different scenarios:

- **a 5 per cent emissions reduction target:** which requires a 5 per cent reduction in emissions below 2000 levels by 2020; and
- **a 15 per cent emissions reduction target:** which requires a 15 per cent reduction in emissions below 2000 levels by 2020.

Both scenarios are based on the assumption that international emissions trading gradually expands; developed economies participate from 2010; developing countries join over time; and there is

global participation by 2025. Under a 5 per cent emissions reduction target, a slower start to global greenhouse gas emissions reductions and stabilisation of emissions in the atmosphere at 550 parts per million (ppm) CO<sub>2</sub>-equivalent or lower are assumed. The 15 per cent emissions reduction target assumes a faster start and stabilisation at 510 ppm.

New measures for the emissions reduction target, including an expanded target, were announced on 4 May 2009 (Australian Government 2009a). In particular, Australia committed to a larger reduction in emissions of 25 per cent below 2000 levels by 2020 subject to an ambitious international agreement involving all major emitters and consistent with stabilisation of emissions at 450 ppm or lower by mid century.

Under all these scenarios, Australia's long-term target is to reduce emissions by 60 per cent below 2000 levels by 2050.

The proposed Carbon Pollution Reduction Scheme (CPRS) aims to reduce emissions of greenhouse gases by placing a limit on aggregate annual emissions from all the covered types and sources of emissions and allowing carbon pollution permits to be traded, with the price of permits to be determined by the market. Box 2.1 contains a brief overview of the scheme. The CPRS is proposed to be phased in from 1 July 2011 but is yet to be legislated.

Other actions include the Clean Energy Initiative (CEI) announced by the Australian Government in May 2009. The CEI is designed to support the research, development and demonstration (RD&D) of low-emission energy technologies, including industrial scale Carbon Capture and Storage (CCS) and solar energy (RET 2009).

Complementing this, the National Low Emissions Coal Initiative established the Carbon Storage Taskforce to develop a National Carbon Mapping and Infrastructure Plan to identify suitable geological storage potential to underpin deployment of CCS in Australia. The Taskforce report is available on [www.ret.gov.au](http://www.ret.gov.au).

Under the CCS Flagships Program, support will be given for the construction and demonstration of large scale integrated carbon capture and storage projects in Australia with a target to create 1000 MW of low emission fossil fuel electricity generation capacity. Also part of the CEI is the Solar Flagships Program which received funding to support the construction and demonstration of large scale solar power stations in Australia with a target of 1000 MW of electricity generation capacity. Under both programs, the commissioning of projects is expected to commence from 2015.

ABARE's latest projections for Australian energy consumption, production and trade to 2029–30 incorporate the RET and a 5 per cent emissions reduction target (below 2000 levels by 2020), as well as other Australian and State/Territory government initiatives (ABARE 2010a). The design of the emissions reduction target modelled in this report is consistent with the proposed CPRS as specified in the White Paper on the CPRS released on 15 December 2008, and amended on 4 May 2009. A summary of these results is presented in section 2.4.3. Further details of the results and assumptions are available in that publication (ABARE 2010a).

The Department of Climate Change regularly publishes annual projections of Australia's greenhouse gas emissions relative to the Kyoto target and on an indicative basis out to 2020 (DCC 2009). This includes projected emissions from the stationary energy sector.

### Energy prices

Energy prices affect the demand for, and supply of, energy. Australia's energy prices are affected by domestic and world supply and demand for energy commodities, as well as factors that influence supply and demand directly and indirectly. For example, climatic events may increase the demand for heating and result in increased world oil prices. Geopolitical factors that could be expected to reduce world supply of oil, such as tensions in the Middle East, generally result in increases in the world oil price. Conversely, events such as the global financial crisis, which reduce the demand for oil as economic activity declines, result in oil prices falling (figure 2.15).

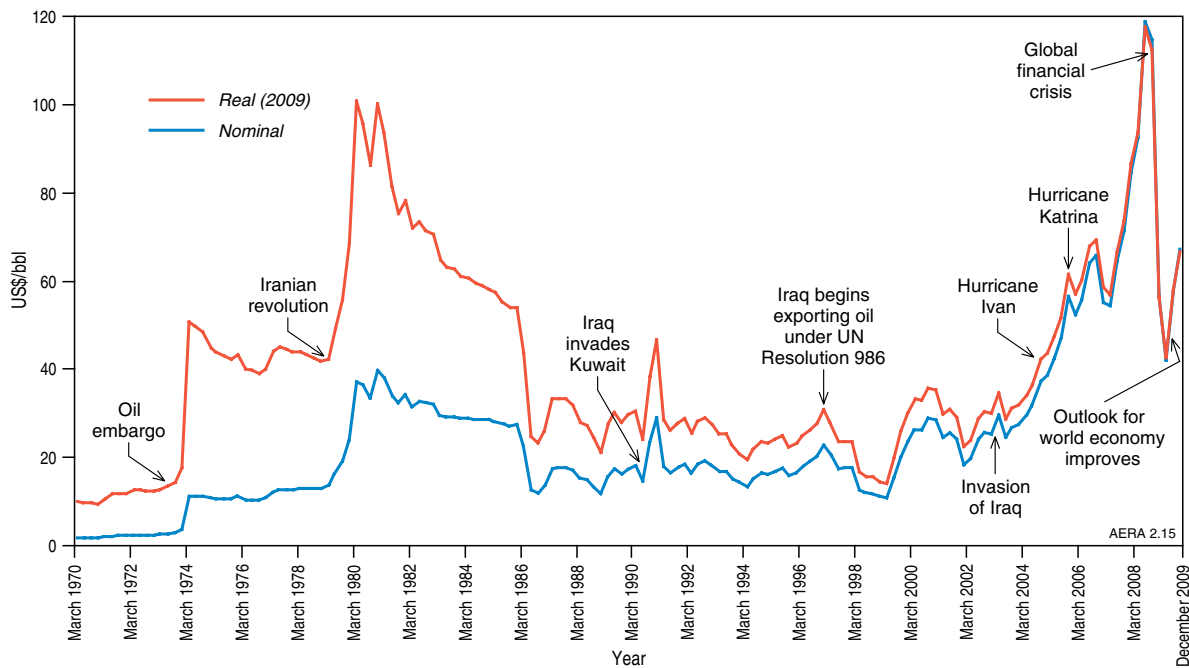


Australia has some of the lowest prices in the OECD for electricity, coal and gas. The abundance of Australia's coal and gas reserves and the proximity of those reserves to areas of high energy demand along the east and west coasts of Australia results in low electricity and gas prices for consumers. Australia is reliant on world oil prices because our domestic reserves and production are relatively small compared with demand.

Real energy prices generally rose for most of the 2000s to mid-2008 following a period of low prices which discouraged investment in new energy

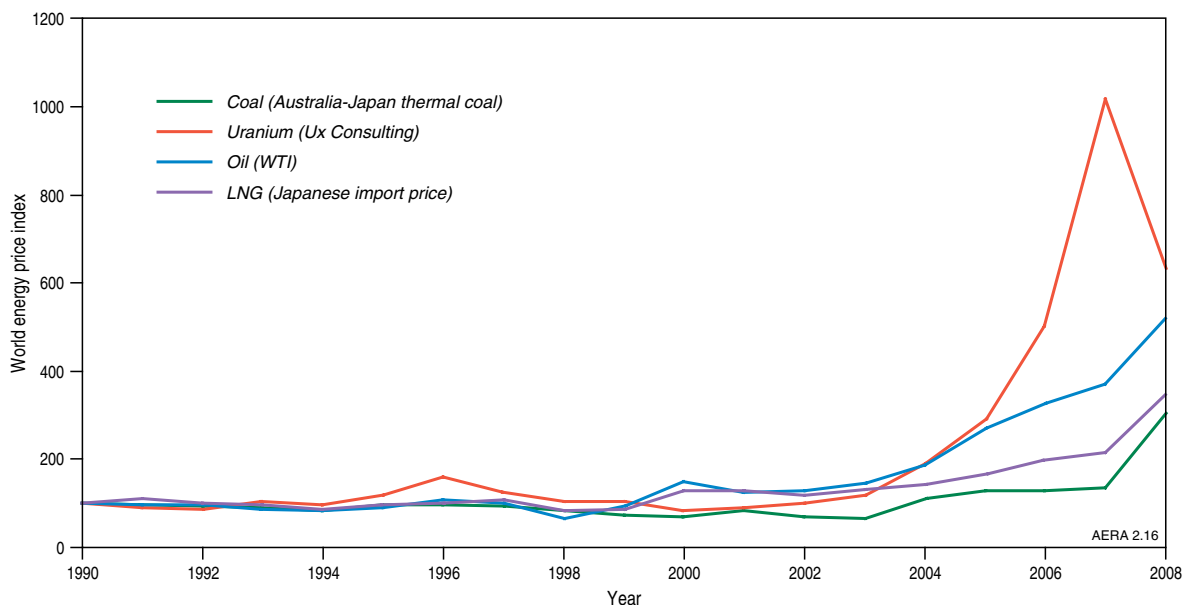
supplies (figure 2.16). The rise in prices reflected strong growth in demand for energy, particularly in China, with suppliers struggling to bring additional production on-line to meet requirements. Energy prices fell sharply in mid-2008 as a result of the global economic downturn (figure 2.15).

After significant declines in energy commodity prices in 2008–09 as a result of the global economic downturn, world prices for these commodities have started to recover in line with the improved outlook for a recovery in world economic growth. Over the medium term, it is expected that a strengthening in global



**Figure 2.15** Crude oil (world trade weighted) prices, 1970 to 2009

Source: ABARE 2009e



**Figure 2.16** World energy price index

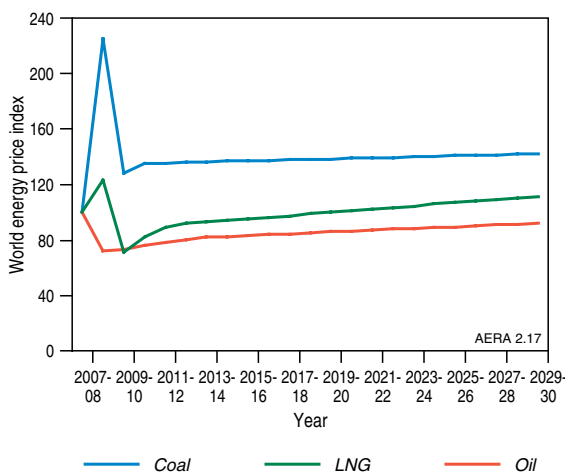
Source: ABARE 2009e

demand, underpinned by the assumed economic recovery, will once again place upward pressure on energy prices, with significant volatility expected to remain. A more detailed assessment of the medium term outlook for energy commodities is provided in *Australian Commodities* (ABARE 2010b).

In the longer term, energy price trends will hinge on a number of factors including not only global demand but also constraints on supply, notably the level of investment in additional production capacity, costs of production, and technology.

Over the past few years, international thermal coal prices have generally followed a similar trajectory to oil and gas prices, as a reflection of inter-fuel substitution possibilities. In the medium term, thermal coal contract prices are assumed to remain above 2007–08 levels, supported by strong demand growth expected in countries such as China and India, combined with continuing infrastructure congestion in key exporting countries, including Australia. Beyond the medium term, global thermal coal prices are expected to increase slowly in real terms reflecting the higher costs associated with developing new mines, including those further inland, being largely offset by the adoption of more advanced technology (figure 2.17).

In the medium term, oil prices are assumed to recover following their substantial decline in the second half of 2008 as a result of the economic recovery and higher oil demand. However, the long term prospects for oil prices are much less certain. Key factors that are expected to drive long term oil prices are the cost of developing remaining oil reserves, the level and timing of investment in production and refining capacity, and technological development in relation to alternative liquid fuels. The estimated capital and production costs for conventional oil sources have increased in recent years due to rising materials, equipment and labour costs. As a result, new oil projects are estimated to be uneconomic at a world



**Figure 2.17** Outlook for world energy prices

Source: ABARE 2010a

price below US\$70 a barrel (ABARE 2010a). While a rise in the marginal cost of production is expected over time, technological developments associated with non-conventional liquids, such as coal-to-liquids, gas-to-liquids, shale oil and second-generation biofuels, have the potential to play a major role in maintaining oil prices at a level that is below what would otherwise be the case without these backstop technologies. The assumed development and entry of these technologies underpins the long term price assumptions used in this report. However, there are clearly uncertainties surrounding this price profile, particularly in terms of the costs of alternative technologies and how these may evolve over time as a consequence of technological developments. Further, the costs of some of these technologies could also be affected by carbon pricing.

Over the long term, LNG prices are assumed to follow a similar trajectory to oil prices, reflecting an assumed continuation of the established relationship between oil prices and long-term LNG supply contracts through indexation, and substitution possibilities in electricity generation and end use sectors. In its 2009 *World Energy Outlook*, the IEA flags a potential relaxation of this relationship as significant new gas supplies – including unconventional gas and LNG – come on line. However, indexation will still remain dominant in the Asia Pacific region, where most of Australia's gas trade will continue to occur (IEA 2009b).

### Emissions intensity – reshaping Australia's electricity generation

Government policies encouraging clean energy will tend to favour those technologies with lower or zero emission intensities – that is, they emit lower or no emissions during electricity generation, excluding those during construction and/or installation.

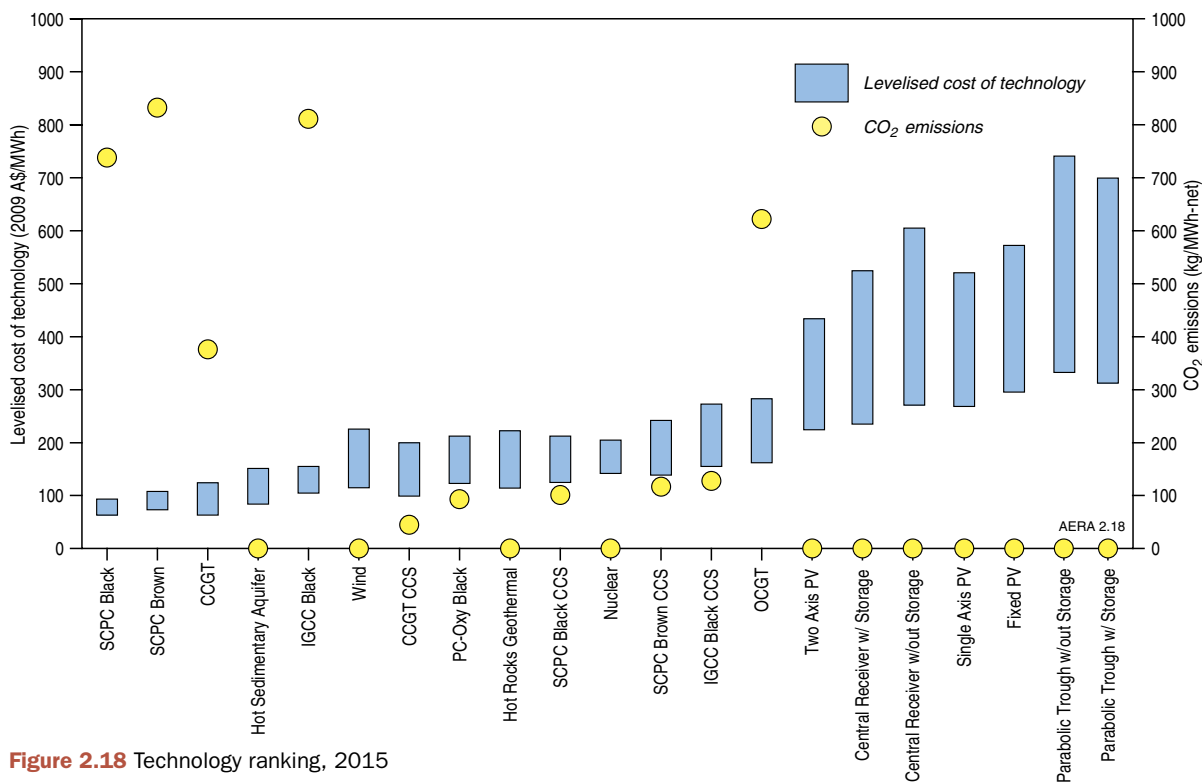
Emissions of carbon dioxide and other greenhouse gases are significantly higher from coal-fired power stations using currently deployed technology than other forms of energy, especially renewable energy (figure 2.18). Gas-fired plants tend to have lower emissions than coal, whereas emissions from renewables (excluding bioenergy) are generally near zero.

The introduction of a price on carbon emissions will raise the price of all fossil fuels to users such as power generators and industry, thereby lowering the relative price of energy from low-carbon fuels and technologies. The impact will be greatest on coal and least on gas, reflecting their different carbon intensities. Carbon pricing favours gas over coal, and renewables over gas. This means that in the longer term, a carbon price favours investment in gas-fired capacity over coal-fired capacity, and investment in renewables over gas (IEA 2009b). However, CCS has the potential to dramatically lower greenhouse emissions from coal- and gas-fired plants. Figure 2.18 shows the substantial reduction in carbon dioxide



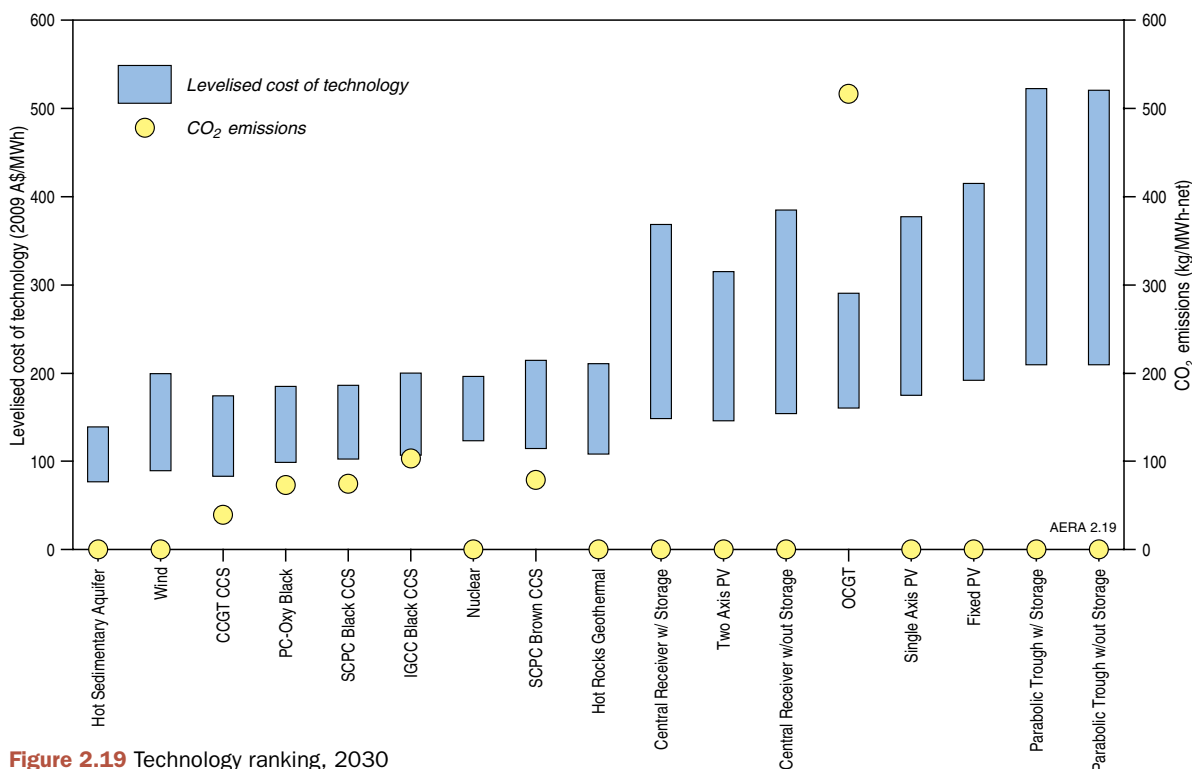
emissions expected in single cycle pulverised coal (black and brown) plants and combined cycle gas turbines which employ CCS technologies compared to the same technology without CCS. Figures 2.18 and 2.19 also show how the relative technology costs change between 2015 and

2030 as learning and experience in technologies improves. There is now substantial investment by both government and industry to accelerate the development and deployment of new technologies, including solar and CCS technologies. CCS is discussed in more detail in Chapter 5.



**Figure 2.18** Technology ranking, 2015

Source: EPRI technology status data, 2010



**Figure 2.19** Technology ranking, 2030

Source: EPRI technology status data, 2010

**Note for 2.18 and 2.19:** EPRI levelised cost of technology estimates based on simplified pro-forma costs, individual projects may lie outside this. Levelised cost of technologies: includes weighted cost of capital (8.4% real before tax); excludes financial support mechanisms; excludes grid connection, transmission, and firming (standing reserve requirements); and includes a notional allowance of 7.5% for site-specific costs.

### Cost competitiveness of energy technologies

The cost imposed by a price on carbon emissions and the demand for energy sources with lower greenhouse gas emissions generally is driving the development of new low emissions energy technologies. Many of these are at different stages of development, demonstration and deployment (see below) and hence have different cost structures.

The Electric Power Research Institute (EPRI) has recently assessed the status of different electricity technologies in 2015 and 2030. This EPRI technology status data enables the comparison of technologies at different levels of maturity. It should not be used to forecast market and investment outcomes. The levelised cost of technologies represents the revenue per unit of electricity generated that must be met to breakeven over the lifetime of a plant. These costs are in 2009 Australian dollars and relate to technologies in 2015 and 2030. The combined impact of uncertainty ranges in plant capital cost, fuel cost, project and site specific costs, and CO<sub>2</sub> transportation and storage costs are shown in figures 2.18 and 2.19.

The technologies covered include:

- Coal (black and brown coal) – including Single Cycle Pulverised Coal (SCPC), Pulverised Coal with Oxy-combustion (PC-Oxy), and Integrated Gasification Combined Cycle (IGCC), all with and without Carbon Capture and Storage (CCS);
- Gas – Open Cycle Gas Turbine (OCGT) and Combined Cycle Gas Turbine (CCGT) both with and without CCS;
- Wind;
- Geothermal – Enhanced Geothermal Systems (EGS) or Hot Rock, and Hot Sedimentary Aquifer (HSA);
- Nuclear;
- Solar Thermal including Central Receiver and Parabolic Trough, all with and without storage; and
- Solar Photovoltaic (PV) including Two Axis, Single Axis and Fixed.

While these technology cost estimates were developed on the basis of generic plant configurations rather than on detailed plant designs or equipment and material costs, and are subject to uncertainty in relation to a number of factors, they provide valuable and comprehensive information on the relative costs of different electricity generation technologies in an Australian setting, and how these costs might change over time. Importantly though, these costs do not include the cost of any carbon price.

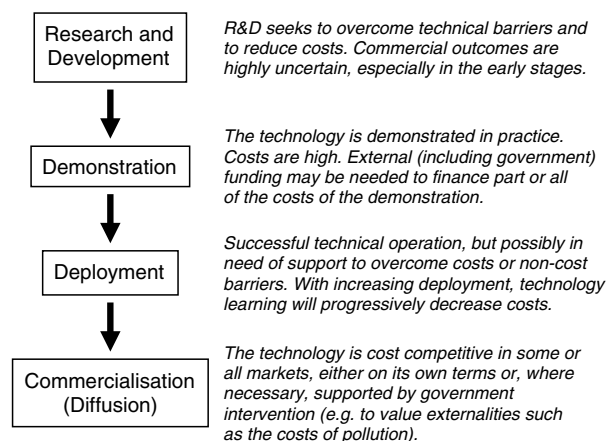
The relative costs of different technologies is more important than the absolute magnitude of these costs in determining their relative prospects in the electricity generation sector (merit order). The EPRI results show that in the medium term, coal and gas will remain amongst the lower technology cost options, although these costs are expected to increase when CCS technology is adopted. Of the renewable energy technologies, wind is one of the lowest cost options. Despite a significant decline in the costs of solar technologies expected in the future, the costs of these technologies are expected to remain relatively high over the coming years. The costs of geothermal are shown to be competitive with other baseload technologies.

### Development of new low emissions energy technologies

The stage of development that a technology is at will also affect its uptake over the next two decades. Most new technologies, including energy technologies, initially have higher costs than incumbent technologies. But over time, the costs of the new technology may decrease through technology learning – as its production costs decrease and its technical performance increases (IEA 2008; figure 2.20).

As an example, wind – as a proven and widely used technology – generally costs less per unit of electricity generation than many other renewable technologies. Those still at development and demonstration stage include a number of solar, ocean and geothermal technologies. Figure 2.21, developed by EPRI, shows the stage of development of key renewable technologies and the relationship of the stage of development to the costs of that technology.

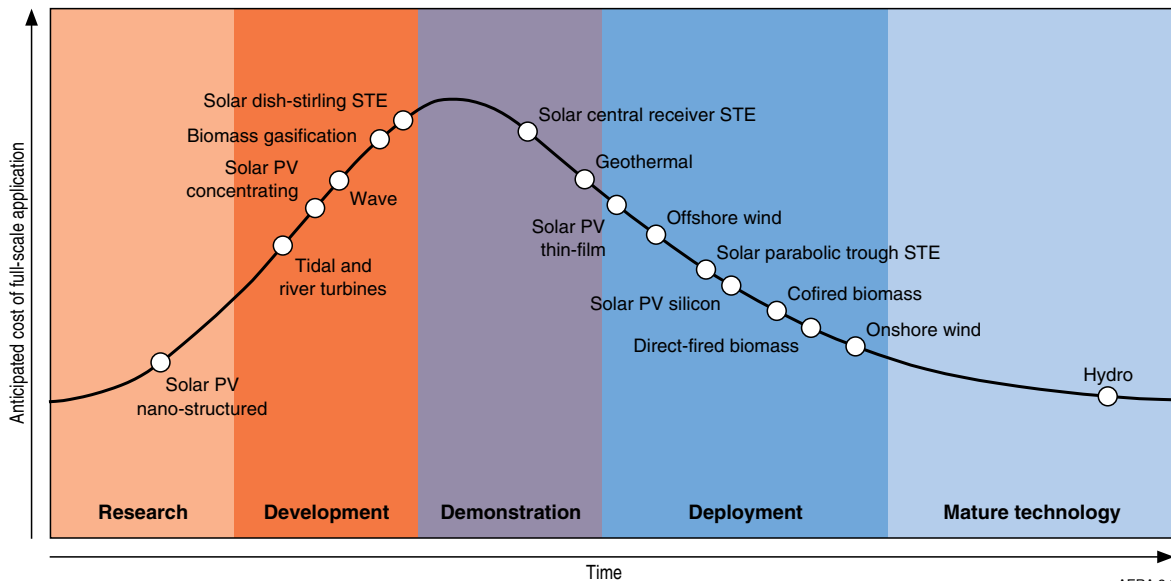
As these technologies advance and technical issues are resolved, it is expected that costs will decrease, encouraging more widespread uptake. The rate of switching from older technologies to these new technologies will depend on both relative costs and



**Figure 2.20** Stages in technology development

**Source:** IEA 2008

AERA 2.20



**Figure 2.21** Grubb curve for a range of renewable energy technologies

AERA 2.21

Source: EPRI technology status data, 2010

on the extent to which consumers value the long term, often at that stage uncertain, benefit of the new technology (IEA 2008).

Governments can also influence the rate at which a technology advances, through assistance in research and development, and in demonstration projects for new technologies. For example, the Australian Government announced the \$4.5 billion Clean Energy Initiative in May 2009, which will support RD&D of low emissions energy technologies, including industrial-scale CCS and solar energy.

Each individual resource chapter includes information on emerging technologies, including their development status, potential benefits, as well as potential barriers to deployment.

**Table 2.5** Energy investment requirements, Australia, 2006–2030

	2006 US\$b
Extraction	222 – 283
Transformation	72 – 95
Transportation	111 – 155
Distribution	9 – 12
<b>Total</b>	<b>414 – 546</b>
Crude oil and petroleum products	33 – 51
Natural gas	180 – 235
Coal	105 – 130
Electricity and heat	96 – 131
Generation	49 – 63
Transmission	39 – 58
Distribution	8 – 10
<b>Total</b>	<b>414 – 546</b>

Source: APERC 2009

### Future energy investment

Any future expansion of Australia's energy market, including access to new energy resources, will require investment in energy infrastructure. Energy infrastructure is currently concentrated in areas where energy consumption is highest and major energy resources are located, particularly along the eastern seaboard of Australia. A significant expansion in Australia's energy infrastructure – particularly electricity generation and transmission – will be required in the next two decades if Australia is to meet its growing and changing demand for energy. Utilising new energy resources, particularly renewables, will require a more flexible and decentralised electricity grid.

The Asia Pacific Energy Research Centre (APERC) released projections of energy investment requirements, from extraction to distribution, to 2030 in November 2009 (APERC 2009). Australia's energy investment requirements estimated by APERC are summarised in table 2.5. APERC estimates that between US\$414 and 546 billion (in 2006 dollars) will be required over the period 2006 to 2030 for the energy sector as a whole. More than half of this is expected to be in resource extraction, and around a quarter in transportation, including rail, pipelines, and electricity transmission lines. Within the electricity sector, more than half of the requirement investment is in generation, and a further 41 per cent in transmission. The requirement could be even greater if Australia commits to accelerated climate change action, particularly increasing the share of renewable energy in electricity generation.

### 2.4.2 Overview of Australian energy production, consumption and trade

#### Production

Australia is the world's ninth largest energy producer, accounting for around 2.4 per cent of the world's energy production (IEA 2009a). Australia produces energy for meeting our domestic energy consumption needs and for export. More than three-quarters of Australia's energy production is currently exported (ABARE 2009a).

Australia's energy production has been increasing at a faster rate than domestic consumption in recent years, driven by growing global demand for energy. Over the period 1999–2000 to 2007–08, energy production increased at an average annual rate of 2.7 per cent, to reach 17 360 PJ in 2007–08. Most of this expansion was driven by coal, uranium and, to a lesser extent, gas (figure 2.22).

The main fuels produced in Australia, on an energy content basis, are coal, uranium and gas. In 2007–08, Australia's energy production was dominated by coal, which accounted for 54 per cent of total energy production in energy content terms, followed by uranium (27 per cent) and gas (11 per cent) (table 2.6). Crude oil, condensate and LPG represented 6 per cent of total production, and renewables represented 2 per cent.

Australian production of renewable energy is dominated by bagasse, wood and wood waste, and hydro electricity, which combined accounted for 86 per cent of renewable energy production in 2007–08. Wind, solar and biofuels accounted for the remainder of Australia's renewable energy production.

**Table 2.6** Australian energy production, 2007–08

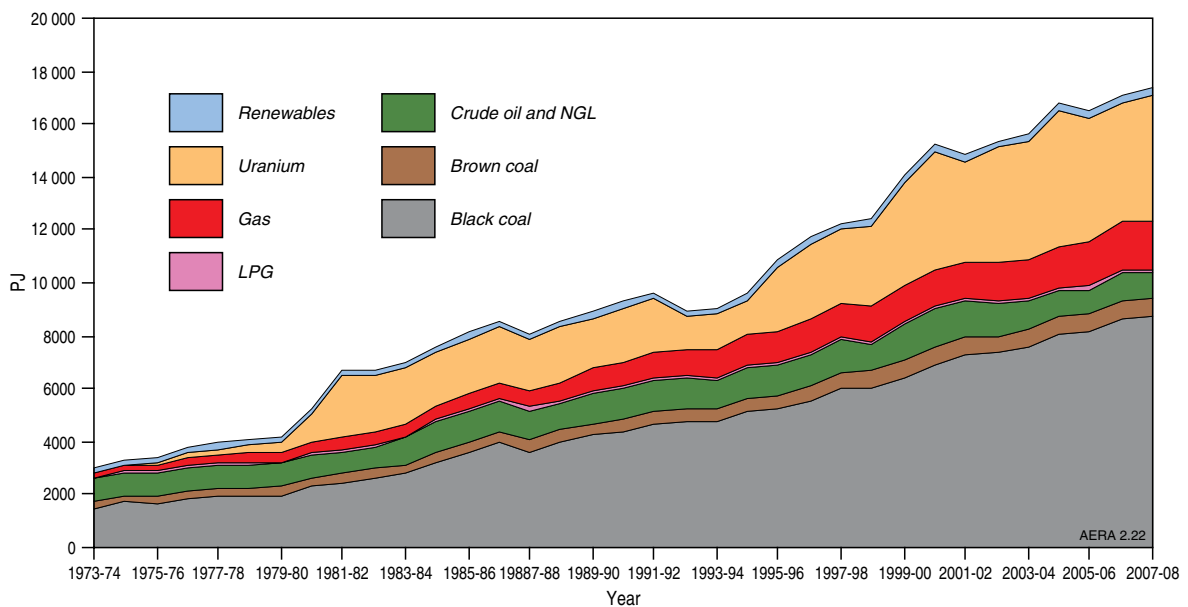
	Production	Share	Average annual growth 1999–00 to 2007–08
	PJ	%	%
<b>Non-renewables</b>	<b>17 070</b>	<b>98.3</b>	<b>2.7</b>
Black coal	8722	50.2	4.0
Brown coal	709	4.1	0.7
Crude oil, LPG, condensate	1059	6.1	-4.3
Gas	1833	10.6	4.2
Uranium	4747	27.3	2.5
<b>Renewables</b>	<b>290</b>	<b>1.7</b>	<b>1.1</b>
Hydro	43	0.3	-4.2
Wind	14	0.1	69.5
Bioenergy	226	1.3	0.3
Solar	7	0.0	13.0
Geothermal	0	0.0	-
<b>Total</b>	<b>17 360</b>	<b>100.0</b>	<b>2.7</b>

Source: ABARE 2009a

#### Primary energy consumption

Australia is the world's twentieth largest primary energy consumer, and ranks fifteenth on a per person basis (IEA 2009a). In 2007–08, energy consumption was 5772 PJ, representing 33 per cent of total Australian energy production (ABARE 2009a).

Although Australia's energy consumption is growing, the rate of growth has been decreasing over the past 50 years. Following annual growth of around 5 per



**Figure 2.22** Australian energy production

Note: NGL = Natural Gas Liquid hydrocarbons (including condensate)

Source: ABARE 2009a

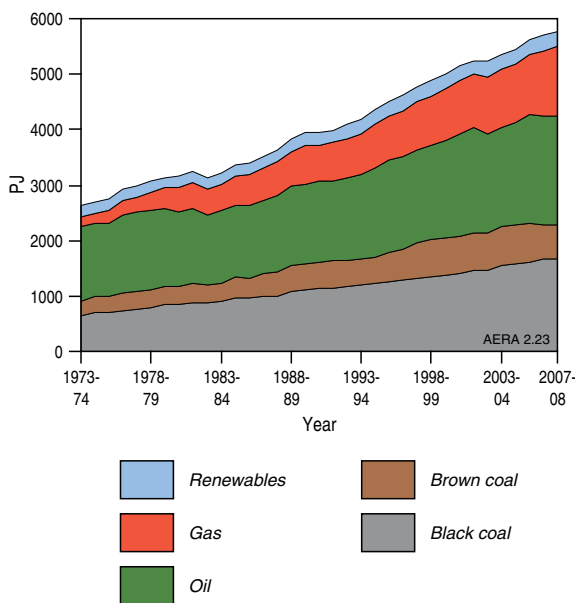
cent during the 1960s, growth in energy consumption fell during the 1970s to an average of around 4 per cent per year, largely as a result of the two major oil price shocks. During the 1980s, economic recession and sharply rising energy prices resulted in annual growth falling to an average of 2.3 per cent. Despite robust economic growth, annual average growth in energy consumption fell to 1.9 per cent over the period from 1999–00 to 2007–08.

This trend indicates a longer term decline in energy intensity of the Australian economy which can

**Table 2.7** Australian primary energy consumption, 2007–08

	Consumption	Share	Average annual growth 1999–00 to 2007–08
	PJ	%	%
<b>Non-renewables</b>	<b>5482</b>	<b>95.0</b>	<b>1.9</b>
Coal	2292	39.7	1.4
Oil	1941	33.6	1.3
Gas	1249	21.6	3.9
<b>Renewables</b>	<b>290</b>	<b>5.0</b>	<b>1.1</b>
Hydro	43	0.8	-4.2
Wind	14	0.2	69.5
Bioenergy	226	3.9	0.3
Solar	7	0.1	13.0
Geothermal	0	0.0	-
<b>Total</b>	<b>5772</b>	<b>100.0</b>	<b>1.9</b>

Source: ABARE 2009a



**Figure 2.23** Australian primary energy consumption, by fuel

Source: ABARE 2009a

be attributed to two main factors. First, greater efficiency has been achieved through technological improvement and fuel switching. Second, rapid growth has occurred in less energy intensive sectors such as the commercial and services sector relative to the more moderate growth of the energy intensive manufacturing sector.

Australian primary energy consumption consists mainly of oil and coal. Black and brown coal accounted for the greater share of the fuel mix, at around 40 per cent, followed by oil (34 per cent), gas (22 per cent) and renewable energy sources (5 per cent) (table 2.7; figure 2.23).

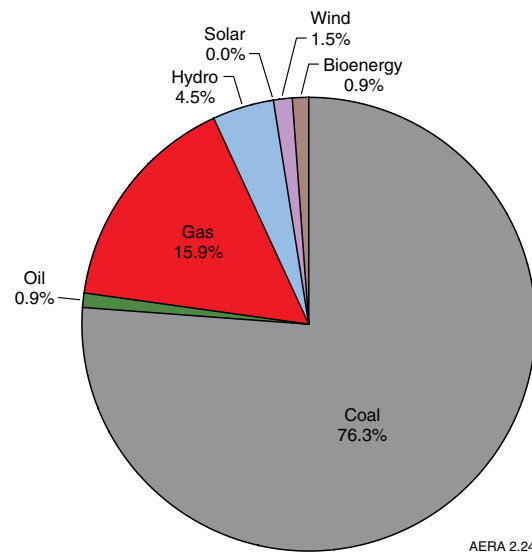
### Electricity generation

Total electricity production in Australia was around 925 PJ (257 TWh) in 2007–08. More than three-quarters of Australia's electricity generation is coal-fired, with a much smaller but increasing contribution from gas (16 per cent) and renewables (7 per cent), predominantly hydro with lesser contributions from bioenergy, wind and solar photovoltaic cells (PV) (figure 2.24). Australia's abundant coal resources, located mostly on the eastern seaboard close to the largest electricity market, have historically provided a relatively low-cost source of fuel.

### Trade

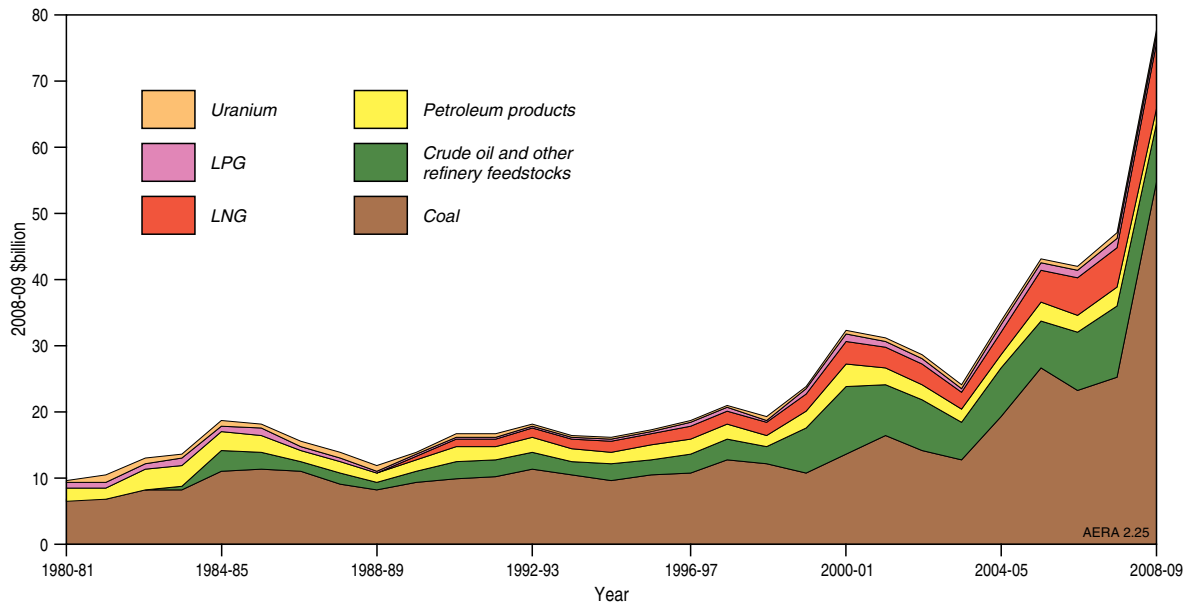
Australia is a net energy exporter. Around 78 per cent of Australia's total domestic energy production is exported. However, Australia is a net importer of crude oil and refined petroleum products. Imports account for around 33 per cent of Australia's total primary energy consumption (ABARE 2009a).

Energy exports accounted for 20 per cent of Australia's total earnings from exports of goods and services in 2007–08. Energy export earnings



**Figure 2.24** Electricity generation by fuel, 2007–08

Source: ABARE



**Figure 2.25** Australian energy exports

Source: ABARE 2009d

**Table 2.8** Australian energy trade, 2007–08

	Export		Import	
	Volume PJ	Value \$m	Volume PJ	Value \$m
Coal	7183	24 403	-	-
Oil and oil products	808	14 446	1678	29 879
LNG	802	5854	202 <sup>a</sup>	724
Uranium	4765	887	-	-
<b>Total</b>	<b>13 559</b>	<b>45 591</b>	<b>1880</b>	<b>30 603</b>

<sup>a</sup> Natural gas produced in the Joint Petroleum Development Area is counted as imports. It is exported from Darwin as LNG

Source: ABARE 2009a, d

increased by 16 per cent in 2007–08 to \$45.6 billion, and then to \$77.9 billion in 2008–09.

The value of Australia's energy exports has grown at an annual rate of around 10 per cent over the past 20 years. Much of this growth has been driven by coal exports – both thermal and metallurgical. LNG and oil exports have also increased in value, supported by increases in international oil prices and higher export volumes (figure 2.25).

Coal is Australia's largest energy export earner, with a value of \$24 billion in 2007–08, followed by crude oil and LNG (table 2.8). More than three-quarters of Australia's black coal production is destined for export. In volume terms, coal was also the largest energy export, accounting for more than half of Australia's energy exports in 2007–08 (on an energy content basis). Uranium exports accounted for more than one third of total exports.

Despite the strong growth in energy exports Australia has limited oil reserves and imports most of its oil needs. Australia's petroleum trade has declined from a surplus of \$3.6 billion in 2000–01 to a deficit of

\$9.3 billion in 2008–09 (2008–09 dollars), despite a \$10 billion surplus for LNG (ABARE 2009d).

### 2.4.3 Outlook for Australia's energy market

ABARE's latest projections for Australian energy consumption, production and trade to 2029–30 incorporate the RET (20 per cent of electricity supply from renewable sources by 2020), a 5 per cent emissions reduction target (below 2000 levels by 2020), and other government initiatives (ABARE 2010a). The design of the emissions reduction target modelled in this report is consistent with the proposed CPRS as specified in the CPRS White Paper released on 15 December 2008, and amended on 4 May 2009 (box 2.1). Further details of the results and assumptions are available in that publication (ABARE 2010a).

ABARE's long term energy projections exclude uranium, because it is not used to produce energy domestically and there are currently no plans to do so. For this energy resource assessment, ABARE has separately modelled the outlook for Australian



uranium production and trade and included it in the results for total energy production and trade. As a result, the projected growth rates and totals for energy production and trade differ from those reported in ABARE (2010a). These and other differences are discussed further in Box 2.2.

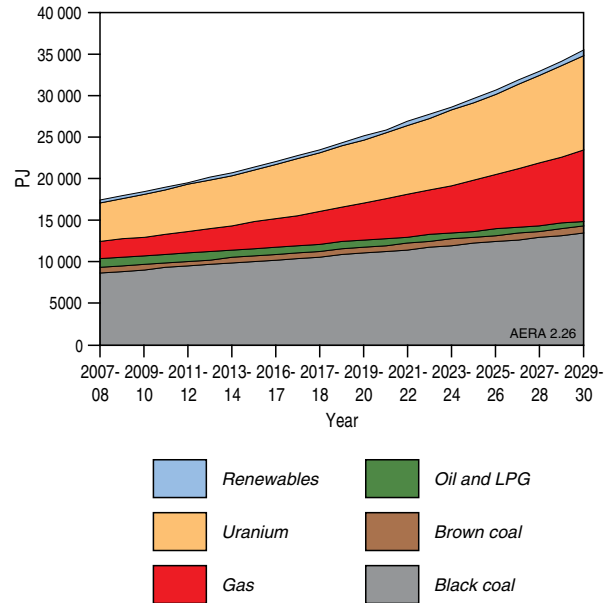
### Energy production

Total production of energy in Australia is projected to grow at an average rate of 3.2 per cent per year. At this rate, Australian production of energy is projected to reach 35 057 PJ in 2029–30 (table 2.9).

Gas production is projected to rise to 8505 PJ in 2029–30, or 24 per cent of total energy production, supported by increased demand both domestically and for export (figure 2.26). The share of uranium and renewables in total energy production is also expected to increase. In contrast, the share of coal in total energy production is projected to fall to 40 per cent by 2029–30, although coal production is still projected to increase by 1.8 per cent per year over the outlook period to reach 13 875 PJ in 2029–30. This growth in production reflects expected strong coal export demand, countering the projected contraction in demand for coal in the domestic market.

### Primary energy consumption

Over the period to 2029–30, Australian energy consumption is projected to increase by 1.4 per cent per year to 7715 PJ in 2029–30. This rate of growth is slower than in previous decades, reflecting the introduction of significant policy measures – the



**Figure 2.26** Fuel mix in Australian energy production, 2007–08 to 2029–30

**Source:** ABARE; ABARE 2010a

RET and the emissions reduction target – both of which are expected to lead to an increase in energy prices, and an associated dampening effect on energy demand. It also reflects the slow down in economic growth in the short term, and ongoing efficiency improvements in the Australian economy. Australia’s aggregate energy intensity (measured as total domestic energy consumption per dollar of GDP) is projected to continue to decline, by around 1.4 per cent per year over the next two decades.

The share of coal in total primary energy consumption is projected to fall to 23 per cent by 2029–30 (figure 2.27; table 2.10). In contrast, the share of gas (conventional and coal seam gas) increases to account for 33 per cent of primary energy consumption in 2029–30.

Gas is expected to be the fastest growing fossil fuel over the projection period. Gas consumption is projected to rise by 3.4 per cent per year over the outlook period, with total primary demand for gas projected to more than double to reach 2575 PJ by 2029–30. This growth in demand is driven primarily by the electricity generation sector and the mining sector, and reflects the shift to less carbon intensive fuels in a carbon constrained environment. As such, much of this growth is at the expense of coal.

In 2007–08, around 5 per cent of energy consumption in Australia was sourced from renewable energy. With the implementation of the RET, the share of renewable energy is projected to increase substantially to account for 8 per cent of primary energy consumption in 2029–30. This implies an average annual growth rate of 3.5 per cent, with the strongest growth expected to occur in geothermal energy (from a very small base), followed

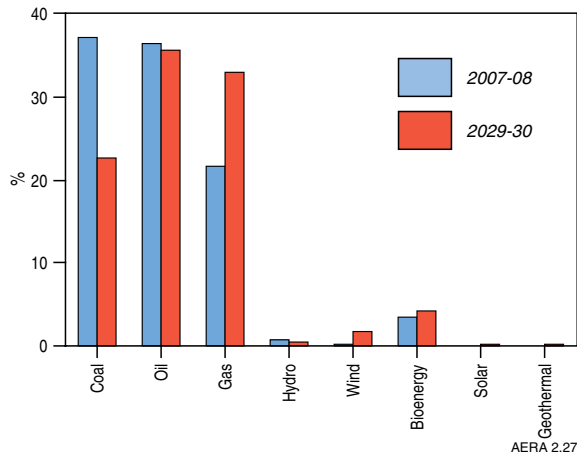
**Table 2.9** Outlook for energy production by fuel, 2029–30

	2029–30	2029–30	Average annual growth
	PJ	%	2007–08 to 2029–30
<b>Non-renewables</b>	<b>34 467</b>	<b>98.3</b>	<b>3.2</b>
Coal	13 875	39.6	1.8
Oil and LPG	668	1.9	-2.0
Gas	8505	24.3	6.7
Uranium	11 420	32.6	4.1
<b>Renewables</b>	<b>590</b>	<b>1.7</b>	<b>3.5</b>
Hydro	46	0.1	0.2
Wind	160	0.5	11.6
Bioenergy	340	1.0	2.2
Solar	24	0.1	5.9
Geothermal	20	0.1	18.4
<b>Total</b>	<b>35 057</b>	<b>100.0</b>	<b>3.2</b>

**Note:** Total energy production differs from that reported in ABARE 2010a because of the inclusion of uranium. See box 2.2 for further explanation

**Source:** ABARE; ABARE 2010a





**Figure 2.27** Fuel mix in Australian primary energy consumption, 2007–08 and 2029–30

Source: ABARE 2010a

by wind and solar. Most of the expansion in renewable energy is projected to take place in the period to 2019–20 reflecting the implementation of the RET.

### Electricity generation

Gross electricity generation in Australia is projected to grow over the outlook period by an average of 1.8 per cent per year to 366 TWh (1318 PJ) in 2029–30.

Under a policy setting that includes the RET, a 5 per cent emissions reduction target and other government initiatives, the relative shares of non-

**Table 2.10** Outlook for primary energy consumption, by fuel, 2029–30

	2029–30	2029–30	Average annual growth 2007–08 to 2029–30
	PJ	%	%
<b>Non-renewables</b>	<b>7125</b>	<b>92.4</b>	<b>1.2</b>
Coal	1763	22.8	-0.8
Oil	2787	36.1	1.3
Gas	2575	33.4	3.4
<b>Renewables</b>	<b>590</b>	<b>7.6</b>	<b>3.5</b>
Hydro	46	0.6	0.2
Wind	160	2.1	11.6
Bioenergy	340	4.4	2.2
Solar	24	0.3	5.9
Geothermal	20	0.3	18.4
<b>Total</b>	<b>7715</b>	<b>100.0</b>	<b>1.4</b>

Source: ABARE 2010a

renewables and renewables in electricity generation are expected to change significantly over the projection period to 2029–30. As a result of the incentives provided under the RET, the share of renewables is projected to increase to around 20 per cent by 2019–20 and remain at that level until the end of the projection period. This reflects the design

### BOX 2.2 STATISTICAL REPORTING ISSUES

ABARE (2010a) *Australian energy projections to 2029–30*, does not include projections for uranium production and trade. This is because uranium is not used to produce energy domestically. For the purposes of this Australian energy resource assessment, ABARE has separately undertaken projections for uranium production and trade to 2029–30. This is to enable a more complete discussion of future demands on Australian energy resources in this assessment. However, as a result, the projections reported here for total energy production and trade and their respective annual growth rates, and thus the shares of individual fuels, differ from those in ABARE (2010a).

The base year (2007–08) data in ABARE (2010a) are drawn from ABARE's Australian Energy Statistics (ABARE 2009a). The 2007–08 data reported in ABARE (2010a) are the results of model calibration and may not be identical to actual 2007–08 data. These slight differences have no material impact on the energy projections presented in this report. This Australian energy resource assessment reports actual 2007–08 data, as it appears in the Australian Energy Statistics (ABARE 2009a). As a result, the 2007–08 data reported in this assessment differs slightly for some fuels to the 2007–08 data reported

in ABARE (2010a). However, the projected growth rates over the period 2007–08 to 2029–30 reported in this assessment are consistent with those in ABARE (2010a).

The figures for gas production in 2007–08 also differ slightly between the Australian Energy Statistics (ABARE 2009a) and ABARE (2010a) to reflect the inclusion in the latter of gas imports of 202 PJ from the Joint Petroleum Development Area (JPDA) in gas production. This is to enable comparison with the gas production projections, which combines the two. Gas resources and production reported by Geoscience Australia also include the JPDA in the total.

There is a range of estimates available for the shares of fuel used in electricity generation in Australia. For 2007–08, this assessment uses unpublished ABARE estimates based on the Australian Energy Statistics (ABARE 2009a). This may differ from other published estimates for a number of reasons, including whether it is based on fuel inputs into electricity generation or electricity output, the conversion factor for fuel inputs to electricity outputs, and the type of generator included (for example, whether off-grid, non-scheduled, cogeneration or small generators are included).

of the RET, which requires a ramp up of renewable energy generation to 45 850 GWh in 2020, and then 45 000 GWh each year until 2030, in addition to what would have been generated without the policy.

Within the category of non-renewable energy, the key change projected over the outlook period is a substitution away from coal-fired generation to gas-fired generation. While coal is expected to continue to dominate the electricity fuel mix under the assumed policy setting, emission pricing leads to a switch from higher-emission energy sources for electricity generation. Coal-fired electricity (both black and brown coal) generation is projected to decrease at an average rate of 0.6 per cent per year over the projection period, leading to a fall in its share to 43 per cent in 2029–30 (table 2.11; figure 2.28).

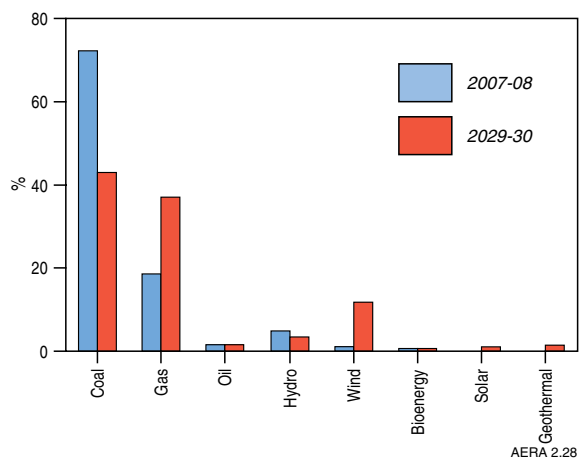
The longer term role of coal is heavily dependent on technological developments related to CCS. The timing for the deployment of CCS technologies hinges on the economic viability of this technology given emission prices. In the modelling undertaken in ABARE (2010a), the deployment of CCS technologies for new plants is not triggered to any significant extent because of their relatively high costs. Nonetheless, the modelling results suggest that, largely due to the development of subsidised projects, some coal-fired electricity generation with CCS will emerge by 2030. In addition, the significant global support to overcome technical and financing hurdles faced by CCS technologies (Global CCS Institute 2009) have the potential to bring forward the large-scale, commercial deployment of CCS technologies for electricity generation and other energy-intensive industries through accelerated cost reductions associated with learning by doing.

**Table 2.11** Electricity generation, by fuel, 2029–30

	2029–30	2029–30	Average annual growth 2007–08 to 2029–30
	TWh	%	%
<b>Non-renewables</b>	<b>297</b>	<b>81.1</b>	<b>1.2</b>
Coal	157	42.8	-0.6
Gas	135	36.8	5.0
Oil	5	1.5	0.0
<b>Renewables</b>	<b>69</b>	<b>18.9</b>	<b>6.2</b>
Hydro	13	3.5	0.2
Wind	44	12.1	11.6
Bioenergy	3	0.7	2.3
Solar	4	1.0	17.4
Geothermal	6	1.5	18.4
<b>Total</b>	<b>366</b>	<b>100.0</b>	<b>1.8</b>

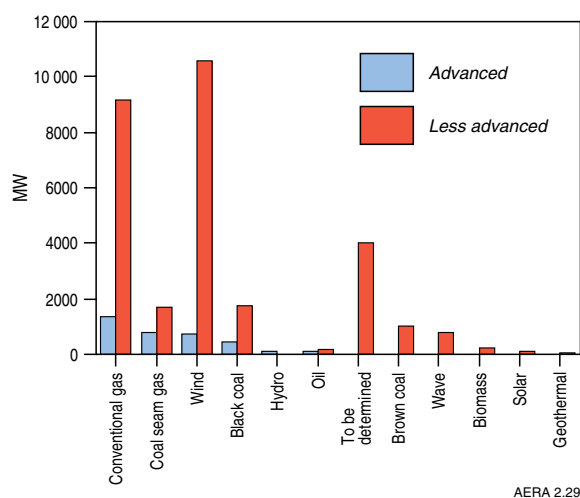
Source: ABARE 2010a

A large part of the decline in coal-fired electricity is taken up by gas-fired generation technologies. The share of gas in electricity generation is projected to rise to 37 per cent in 2029–30. The projected increase in gas-fired electricity generation is supported by its major share of currently committed electricity generation capacity (figure 2.29). As of October 2009, conventional gas and coal seam gas accounted for 60 per cent of the total capacity of advanced electricity generation projects in Australia, with more than 2100 MW of new gas-fired plants committed or under construction (ABARE 2009f). Gas-fired generation is a mature technology with competitive cost structures relative to new and renewable technologies. As such, it has the potential to play a major role in the transition period until lower-emission technologies become more cost effective. The flexibility of gas-fired turbines (notably open cycle gas turbines) will underpin a greater role as peaking plants providing stand-by electricity generation capacity



**Figure 2.28** Fuel mix in Australian electricity generation, 2007–08 and 2029–30

Source: ABARE 2010a



**Figure 2.29** Major electricity generation projects at various stages of development

Source: ABARE 2009f

as backing for a greater contribution from intermittent renewable energy production, especially wind energy.

In parallel with the increasing share of gas in the electricity fuel mix, these projections highlight the significant expansion in the use of non-hydro renewable energy resources between 2007–08 and 2029–30. Wind energy is projected to account for the majority of the increase in electricity generation from renewable sources over the projection period to account for 12 per cent of electricity generation in 2029–30. Within the renewable technology cluster, wind energy is a proven technology with relatively lower costs. The growth in wind energy is being supported by growth in the use of gas-fired plants as a source of flexible, peaking electricity generation. This is likely to lead to greater convergence of the gas and electricity markets (AEMC 2009).

Given Australia's large potential bioenergy resources, the potential commercialisation of second generation technologies, and the RET, bioenergy has the potential to make a growing contribution to renewable electricity generation in Australia. However, this growth potential is likely to be constrained to some extent by competition for bioenergy resources, land and water availability, and logistical issues associated with handling, transport and storage. Bioenergy for electricity generation is projected to grow by 2.3 per cent per year over the period to 2029–30 accounting for nearly 1 per cent of electricity generated in that year.

Solar energy is projected to grow at an average annual rate of 17 per cent, albeit from a very low base. Electricity generation from solar energy in Australia is currently almost entirely sourced from PV installations. Electricity generation from solar thermal systems is currently limited to small pilot projects, although interest in solar thermal systems for large scale electricity generation is increasing. The high investment costs of solar technologies represent the most important barrier to their deployment. However, there is considerable scope for the cost of these technologies to decline significantly over time. The uptake of solar energy, and renewable energy sources generally, will also depend on government policies aimed at reducing greenhouse gas emissions. In the first instance, uptake will be driven by projects subsidised under various policies and programs, and will be from a low base. In this context, the RET, the Clean Energy Initiative and the proposed emissions reduction target are all expected to underpin the growth of solar energy in Australia over the outlook period. Government support for technology research, development and demonstration is likely to play a significant role in accelerating the development and commercialisation of large-scale solar power stations.

Australia is considered to have considerable Hot Rock and potentially Hot Sedimentary Aquifer geothermal

energy potential. Exploration for geothermal resources is taking place in all states and the Northern Territory. Electricity generation from geothermal energy in Australia is currently limited to a single small operation but several projects are at proof-of-concept or early commercial demonstration stage. A significant impediment to geothermal electricity generation is the distance of many of the resources from existing transmission lines or consumption centres. Given the major investment in geothermal energy RD&D by both government and industry in Australia, it is considered likely that commercial-scale geothermal power will become commercially viable over the outlook period. Geothermal energy is projected to account for 1.5 per cent of electricity generation by 2029–30.

Hydroelectricity generation is projected to remain broadly unchanged over the outlook period, reflecting the limited availability of suitable locations for the expansion of large grid-based hydroelectricity generation and water supply constraints. Most of the projected expansion in capacity is assumed to be associated with the upgrading of existing equipment and the development of small-scale schemes.

While Australia has abundant and widespread renewable energy resources, the projected major shift to renewables will depend on the rate of technological advances and demonstration of commercial viability, with attendant reduction in the cost of the technologies. This applies particularly to solar and geothermal in the first instance (being further along the Grubb curve as shown in figure 2.21) as well as wave and tidal energy. Government support is expected to be important in development and demonstration of these new technologies. The uptake of renewable energy will also be influenced by timely and adequate investment in infrastructure development.

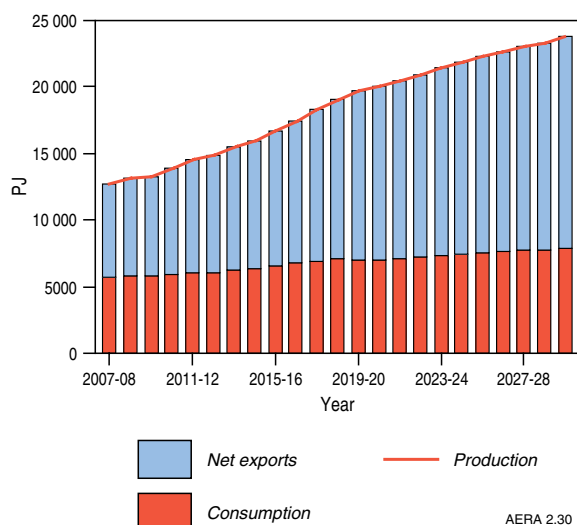


Figure 2.30 Australia's energy supply-demand balance, excluding uranium, 2007–08 to 2029–30

Source: ABARE 2010a

**Table 2.12** Net trade in energy, 2029–30

	2029–30	Average annual growth 2007–08 to 2029–30
	PJ	%
Black coal	12 112	2.4
Oil <sup>a</sup>	-2211	3.3
LPG	92	3.8
LNG	5930	9.5
Uranium	11 420	4.1

<sup>a</sup> Includes crude oil, other refinery feedstock and petroleum products

Source: ABARE, ABARE 2010a

## Energy trade

As the projected growth in energy production exceeds that of primary energy consumption, Australia's exportable surplus of energy is projected to increase as a proportion of consumption over the projection period (figure 2.30).

Black coal, which includes both thermal and metallurgical coal, is projected to remain Australia's dominant energy export. The projected annual growth rate of 2.4 percent, to reach 12 112 PJ by 2029–30 (table 2.12), is built on expectations that global demand for coal will continue to increase in the period to 2030 as a result of increased demand for electricity and steel making raw materials, particularly in emerging market economies in Asia. Australia, with its abundant resources of high-quality coal, has the potential to contribute significantly to meeting this increased demand, subject to adequate investment in mine and related infrastructure development.

Growth in LNG exports will be supported by the development of a number of expansion and greenfield projects, both in north west Australia and based on CSG on the east coast, to meeting growing world demand for LNG, particularly in Asia. LNG exports are projected to reach 5930 PJ in 2029–30.

With declining oil production, Australia's net trade position for liquid fuels is expected to weaken over the outlook period, with net imports increasing by 3.3 per cent per year over the projection period.

Uranium exports are also projected to increase strongly over the period to 2029–30 to meet growing Asian investment in nuclear capacity, by more than 4 per cent per year to reach 11 420 PJ.

## 2.5 References

ABARE (Australian Bureau of Agricultural and Resource Economics), 2009a, Australian Energy Statistics, Canberra, August

ABARE, 2009b, Energy in Australia 2009, Canberra, April

ABARE, 2009c, Minerals and energy: Major development projects – October 2009 listing, Canberra, November

ABARE, 2009d, Australian Commodities, vol. 16, no. 4, December quarter, Canberra

ABARE, 2009e, Australian Commodity Statistics 2009, Canberra, December

ABARE, 2009f, Electricity generation: Major development projects – October 2009 listing, Canberra, November

ABARE, 2010a, Australian energy projections to 2029–30, ABARE research report 10.02, prepared for the Department of Resources, Energy and Tourism, Canberra

ABARE, 2010b, Australian Commodities, vol. 17, no. 1, March quarter, Canberra

ABS (Australian Bureau of Statistics), 2008, Population Projections, Australia, 2006–2101, catalogue 3222.0, September

ABS, 2009, Australian Demographic Statistics, March 2009, catalogue 3101.0, September

AEMC (Australian Energy Market Commission), 2009, Review of Energy Market frameworks in light of Climate Change Policies. Final Report. September, Sydney

AEMO (Australian Energy Market Operator), 2009, Corporate Profile <[www.aemo.com.au/corporate/0000-0002.pdf](http://www.aemo.com.au/corporate/0000-0002.pdf)>

AER (Australian Energy Regulator), 2009, State of the Energy Market 2009. The Australian Competition and Consumer Commission, Melbourne

APERC (Asia Pacific Energy Research Centre), 2009, APEC Energy Demand and Supply Outlook, 4th edition, Institute of Energy Economics Japan, Tokyo, November

APIA (Australian Pipeline Industry Association), 2009, Facts and figures, <<http://www.apia.net.au/industry/facts-and-figures/>>

Australian Government, 2008a, Carbon Pollution Reduction Scheme: Australia's Low Pollution Future, Canberra, December

Australian Government, 2009, New Measures for the Carbon Pollution Reduction Scheme, <<http://www.climatechange.gov.au/minister/wong/2009/media-releases/May/mr20090504.aspx>>

BP, 2009, BP Statistical Review of World Energy, London, June

CSIRO, 2009, Intelligent Grid. A value proposition for distributed energy in Australia, CSIRO Report ET/IR 1152,

DCC (Department of Climate Change), 2009, Tracking to Kyoto and 2020, Australia's Greenhouse Emissions Trends 1990 to 2008–12 and 2020, Canberra, August, <<http://www.climatechange.gov.au/en/publications/projections/tracking-to-kyoto.aspx>>

EPRI (Electric Power Research Institute), 2010, EPRI technology status data, <<http://www.epri.com>>

Geoscience Australia, 2009a, Australia's identified mineral resources, Canberra

Geoscience Australia, 2009b, Oil and gas resources of Australia 2008, Canberra

Geoscience Australia, 2009c, Map of operating renewable energy generators in Australia, Canberra, <<http://www.ga.gov.au/renewable/>>

Global CCS Institute 2009, Strategic Analysis of the Global Status of Carbon Capture and Storage, <<http://www.globalccsinstitute.com/downloads/Status-of-CCS-WorleyParsons-Report-Synthesis.pdf>>

IEA (International Energy Agency), 2008, Energy Technology Perspectives 2008 – Scenarios and Strategies to 2050, OECD, Paris

IEA, 2009a, World Energy Balances, 2009 edition, OECD, Paris

IEA 2009b, World Energy Outlook, OECD, Paris, November

Ports Australia, 2009, Australia's Ports Industry, <[http://www.portsaustralia.com.au/port\\_industry/](http://www.portsaustralia.com.au/port_industry/)>

RET (Department of Resources, Energy and Tourism), 2009, Clean Energy Initiative, <[http://www.ret.gov.au/Department/Documents/CEI%20Fact%20Sheet%20\(13%20May%202009\).pdf](http://www.ret.gov.au/Department/Documents/CEI%20Fact%20Sheet%20(13%20May%202009).pdf)>

# Chapter 3 Oil



## 3.1 Summary

### KEY MESSAGES

- Oil is the most widely used primary source of energy globally. It plays a critical role as a transport fuel in most countries including Australia.
- Australia has about 0.3 per cent of world oil reserves. Australia has limited reserves of crude oil and most of Australia's known remaining oil resources are condensate and liquefied petroleum gas (LPG) associated with giant offshore gas fields.
- There is scope for growth in Australia's oil reserves in existing fields, and for new oil discoveries in both proven basins and in under-explored frontier basins which are prospective for petroleum.
- There is also potential to develop alternative transport fuels such as biofuels, coal-to-liquids (CTL), gas-to-liquids (GTL) and shale oil.
- Australia's oil consumption is projected to increase over the two next decades but the rate of growth is projected to be slower than in the past 20 years. Domestic crude oil production is projected to continue to decline.
- In the absence of major new discoveries and the development of alternatives, Australia's net imports of liquid fuels are projected to increase, rising to be three-quarters of consumption by 2029–30.

### 3.1.1 World oil resources and market

- Oil is an important energy source, accounting for around 34 per cent of world primary energy consumption in 2007. However, its importance has been declining steadily since the 1970s when its share of primary energy consumption was around 45 per cent.
- World proven oil reserves were estimated at some 1.4 trillion barrels (equivalent to 8.3 million PJ) at the end of 2008. This is equal to around 42 years supply at current production rates. This global reserves to production ratio has been maintained at around 40 years for the past decade. Australia accounted for around 0.3 per cent of these reserves.
- World oil production was around 30.5 billion barrels (174 012 PJ) in 2008. Major oil producers include Saudi Arabia, the Russian Federation, United States, Iran and China, with the Middle East accounting for 31 per cent of the world's production in 2008.
- The cost of oil production is expected to increase with the development of deeper water fields and the use of enhanced recovery technologies.
- World oil consumption has increased at an annual average rate of 1.6 per cent since 2000, to reach 31.6 billion barrels (Bbbl, 171 236 PJ) in 2008.
- The fastest growing oil consuming region is non-

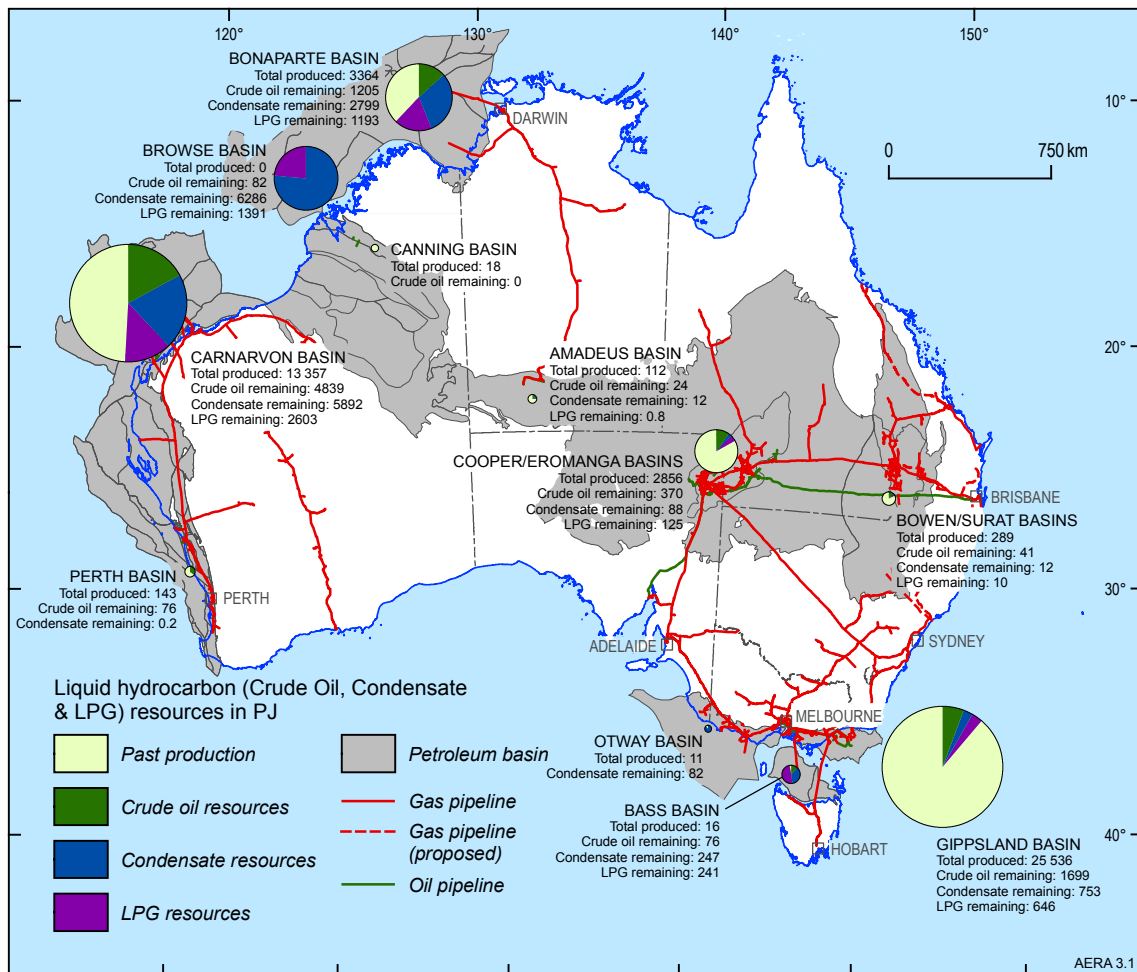
OECD Asia, which includes China and India. At present more than half of world oil consumption is used in the transport sector.

- World oil demand is projected by the International Energy Agency (IEA) in its reference case to increase by around 1 per cent per year to reach 36.8 Bbbl (210 271 PJ) in 2030. Demand growth is expected to be concentrated in non-OECD economies.
- World oil supply is also projected to increase at an average annual rate of 1 per cent. OPEC's oil production is projected to grow as is supply from unconventional sources such as oil sands, gas-to-liquids, coal-to-liquids and oil shale.

### 3.1.2 Australia's oil resources

- In 2008, Australia's identified oil resources were estimated at 30 794 PJ made up of 16 170 PJ (2750 million barrels or mmbbl) of condensate, 8414 PJ (1431 mmbbl) of crude oil and 6210 PJ (1475 mmbbl) of LPG (liquefied petroleum gas).
- Australia has only limited domestic supplies of crude oil, and relies increasingly on imports to meet demand.
- Crude oil exploration in Australia has not repeated the early success of the 1960s when the first offshore exploration yielded giant field discoveries in the Gippsland Basin. Although Australia has over





**Figure 3.1** Australian crude oil, condensate and naturally-occurring LPG resources, infrastructure, past production and remaining resources

**Source:** Geoscience Australia

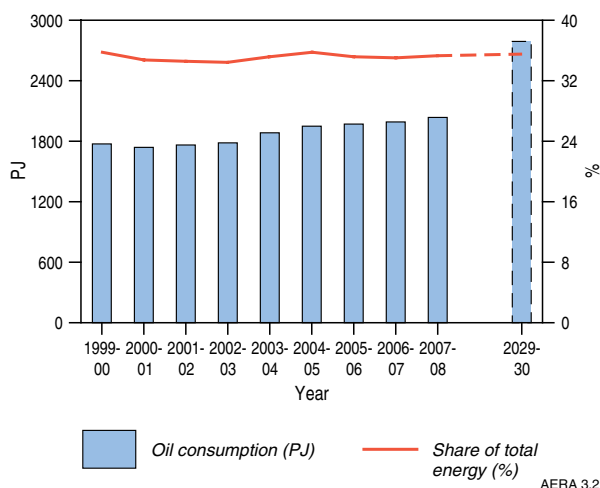
300 crude oil fields, most production has come from only seven major fields.

- Estimates of undiscovered crude oil in proven basins range from 9996 PJ (1700 mmbbl) to 29 588 PJ (5032 mmbbl) and undiscovered condensate from 4116 PJ (700 mmbbl) to 35 480 PJ (6035 mmbbl). Petroleum potential exists in deep water frontier basins but the oil resource remains unknown.
- Australia's largest remaining discovered liquid petroleum resource is now the condensate and LPG in the undeveloped Ichthys gas field in the offshore Browse Basin (figure 3.1).
- The scope for enhanced oil recovery (EOR) from identified fields was estimated at about 6468 PJ (1100 mmbbls) in 2005. Additions to resources from field growth were estimated at about 5880 PJ (1000 mmbbls) in 2004. In the intervening period some of this potential has been realised.
- In addition, Australia has a large unconventional and currently non-producing identified shale oil

resource of 131 600 PJ (22 390 mmbbl) which could potentially contribute to future oil supply if economic and environmental challenges can be overcome.

### 3.1.3 Australia's oil market

- Oil and oil products have the second largest share (1942 PJ or 34 per cent) of primary energy consumption in Australia, but domestic primary oil (crude oil, condensate and LPG) production accounts for only 6 per cent of total energy production. Australia's net imports of oil and oil products represented 45 per cent of consumption in 2007–08.
- Australian primary oil production (crude oil, condensate and LPG) peaked in 2000–01 at 1546 PJ (276 mmbbl). Since then primary oil production has been declining at an average rate of 5 per cent per year to 1059 PJ (187 mmbbl, 29.8 GL) in 2007–08.
- Australia is a net importer of oil and oil products. In 2007–08, Australia's net imports of primary oil were around 383 PJ (48 mmbbl, 7.7 GL), valued at \$5.5 billion.



**Figure 3.2** Australia's outlook for oil consumption

Source: ABARE 2009b; ABARE 2010

- Australian refineries produced 1557 PJ (269 mmbbl, 42.8 GL) of refined oil products in 2007–08.
- In the past, Australia was a net exporter of refined oil products. Since the closure of the Port Stanvac refinery in 2003, Australia has also become a net importer of these products. In 2007–08, Australia's net import of refined oil was around 430 PJ (94 mmbbl, 15 GL), valued at \$12 billion.
- The transport sector is the largest consumer of oil, accounting for around 70 per cent of Australia's total use of oil products.
- In ABARE's latest long term energy projections, which include the Renewable Energy Target, a 5 per cent emissions reduction target and other government policies, consumption of oil and oil products in Australia is projected to increase by 1.3 per cent per year to reach 2787 PJ (equivalent to about 473 mmbbl) in 2029–30. Its share of primary energy consumption is projected to remain around 36 per cent in 2029–30 (figure 3.2).
- Australian production of crude oil, condensate and LPG is projected to decline at an average rate of 2 per cent per year to 668 PJ by 2029–30.
- Net imports of oil and oil products are projected to account for 76 per cent of consumption in 2029–30.

## 3.2 Background information and world market

### 3.2.1 Definitions

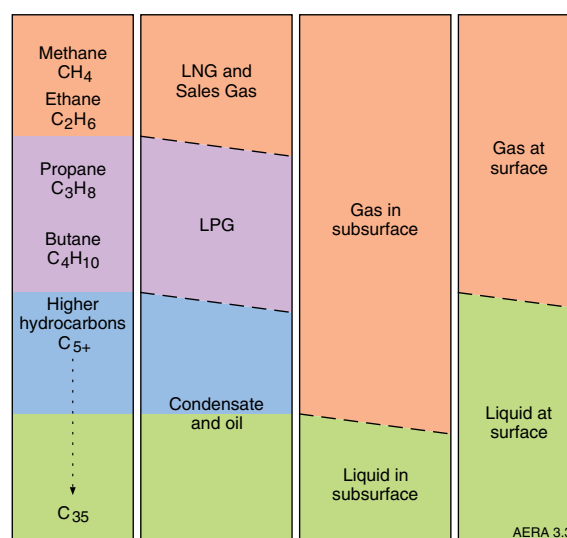
The term oil encompasses the range of liquid hydrocarbons and includes crude oil and condensate. Liquefied petroleum gas (LPG) is considered along

with oil in this study. Oil that has been refined into other products is referred to as refined products, oil products or petroleum products.

**Crude oil** is a naturally-occurring liquid consisting mainly of hydrocarbons derived from the thermal and chemical alteration of organic matter buried in sedimentary basins. It is formed as organic-rich rocks are buried and heated over geological time. Crude oil varies widely in appearance, chemical composition and viscosity. Most Australian crude oils are classified as light oil. Light crude oils are liquids with low density and low viscosity that flow freely at standard conditions: they have high API gravity due to the presence of light hydrocarbons. Heavy oils, on the other hand, have higher density and viscosity, do not flow readily and have low API gravity (less than 20°) having lost the lighter hydrocarbons. Crude oil is found in deposits with or without associated gas; this gas may include natural gas liquids – condensate and liquefied petroleum gas (LPG). Crude oil can also be found in semi-solid form mixed with sand and water (oil or tar sands) or as an oil precursor, also in solid form, called oil shale. Oil from oil sands and oil shale is known as unconventional oil (box 3.1).

**Condensate** is a liquid mixture of pentane and heavier hydrocarbons found in oil fields with associated gas or in gas fields. It is a gas in the subsurface reservoir, but condenses to form a liquid when produced and brought to the surface (figure 3.3).

**Liquefied petroleum gas (LPG)** is a mixture of lighter hydrocarbons, such as propane and butane, and is normally a gas at the surface. It is usually stored and transported as a liquid under pressure. In addition to naturally-occurring LPG, it is also produced as a by-product of crude oil refining. LPG has lower energy



**Figure 3.3** Petroleum resources nomenclature in terms of chemical composition, commercial product, physical state in the subsurface and physical state at the surface

Source: Geoscience Australia



content per volume than condensate and crude oil (Appendix E).

**Refined products** include petroleum products used as fuels (LPG, aviation gasoline, automotive gasoline, power kerosene, aviation turbine fuel, lighting kerosene, heating oil, automotive diesel oil, industrial diesel fuel, fuel oil, refinery fuel and naphtha) and refined products used in non-fuel applications (solvents, lubricants, bitumen, waxes, petroleum coke for anode production and specialised feedstocks).

**Primary oil consumption** includes all petroleum used directly as fuel – crude oil, condensate, LPG and petroleum products.

**Primary oil production** includes crude oil, condensate and naturally occurring LPG prior to use in refineries.

**Oil shale** is a fine-grained sedimentary rock containing large amounts of organic matter (kerogen), which can yield substantial quantities of hydrocarbons. Oil shale is essentially a very rich thermally immature source rock: it requires heating to high temperatures to convert the organic material within the shale to liquid hydrocarbons – shale oil. Shale oil is considered an alternative transport fuel, readily substitutable for high grade crude oil.

**Oil sands**, or tar sands, are sandstones impregnated with bitumen, the very viscous heavy hydrocarbons remaining after the more volatile components of crude oil have been lost. Mining and processing is required to recover the oil.

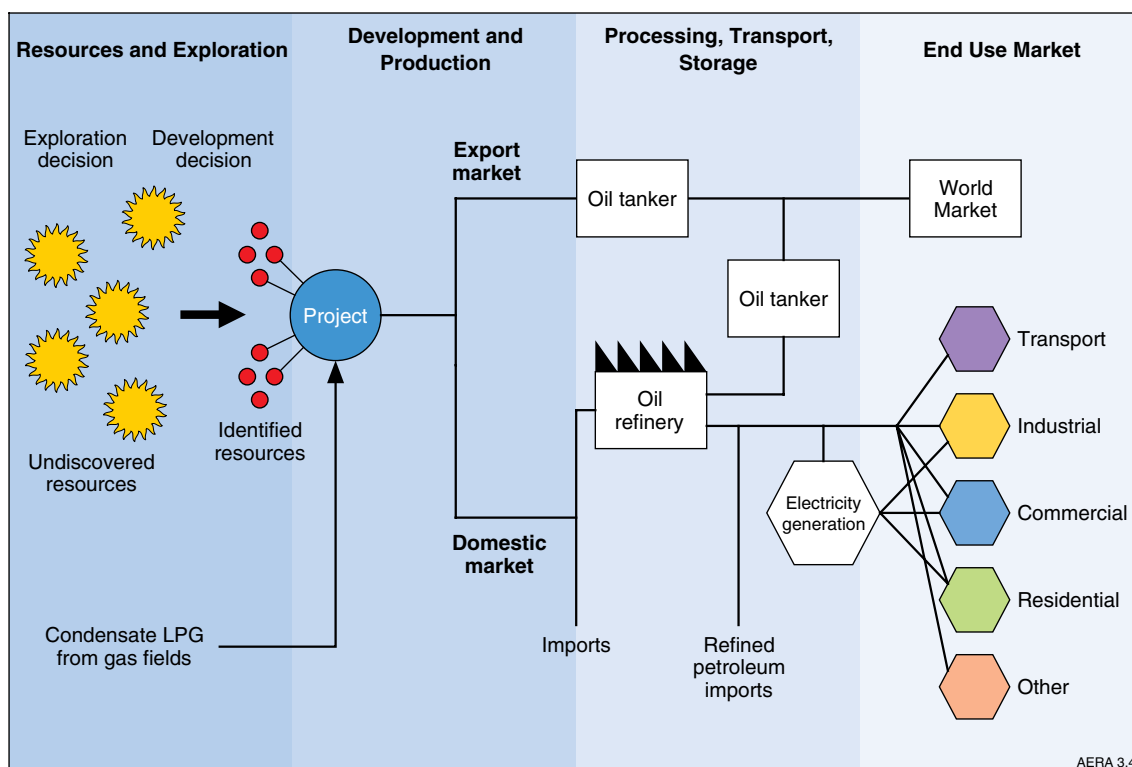
### 3.2.2 Oil supply chain

Figure 3.4 provides a representation of the oil industry in Australia. The oil industry undertakes the exploration, development and production of crude oil, condensate and LPG. More generally, the petroleum industry also includes downstream activities such as petroleum refining, and the transport and marketing of refined products, as well as non-energy products such as petrochemicals and plastics.

#### Resources and exploration

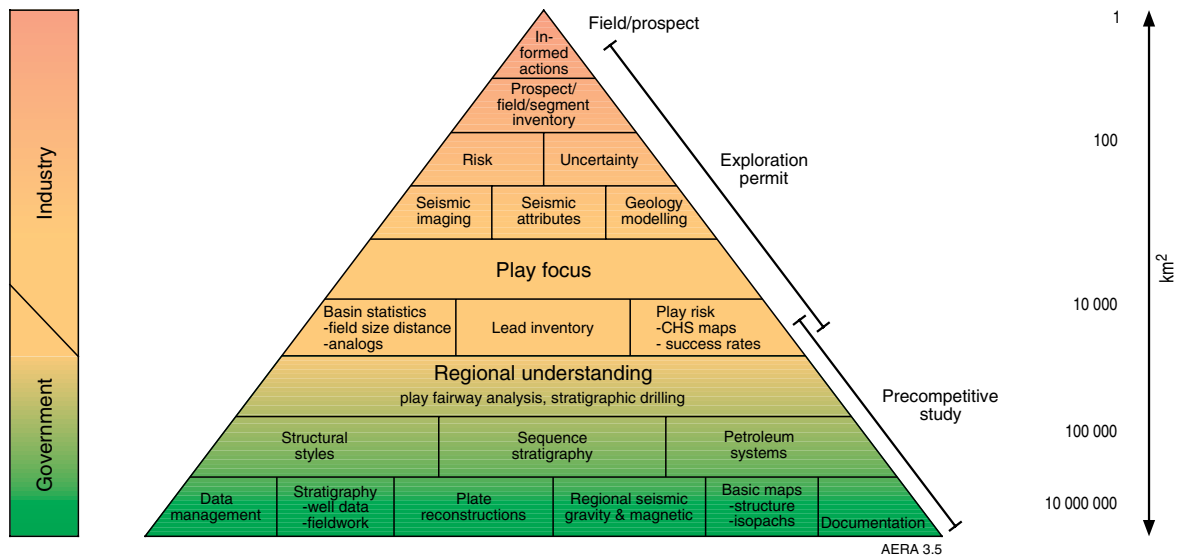
The supply of oil begins with undiscovered resources that must be identified through exploration. Geoscientists identify areas where hydrocarbons are liable to be trapped in the subsurface, that is in sedimentary basins of sufficient thickness to contain mature petroleum source rocks as well as suitable reservoir and seal rocks in trap configurations (box 3.1). The search narrows from broad regional geological studies through to determining an individual drilling target.

In the Australian context, governments have taken a key role in providing regional pre-competitive data to encourage investment in exploration by the private sector (figure 3.5). Company access to prospective exploration areas is by competitive bidding, usually on the basis of proposed work program (that is intended exploration effort) or by taking equity in ('farming-into') existing acreage holdings.



**Figure 3.4** Australia's oil supply chain

**Source:** ABARE and Geoscience Australia



**Figure 3.5** The resource discovery triangle

**Source:** Geoscience Australia (adapted from BP)

Reflection seismic is the primary technology used to identify likely hydrocarbon-bearing structures in the sub-surface. Drilling is then required to test whether the structure contains oil or gas, or both, or neither. The initial discovery well may be followed by appraisal drilling and/or the collection of further survey data (often 3D seismic) to help determine the extent of the accumulation.

### Development and production

Once an economically recoverable resource has been identified, it is a matter of deciding whether to proceed to development based on project economics, market conditions (oil prices and cost of extraction technologies and facilities) and the availability of finance.

The development phase involves the construction of the infrastructure required for the production of the oil resource. Depending on the location, this infrastructure includes development wells, production facilities, a gathering system to connect individual wells to processing facilities, temporary storage and transport facilities.

In Australia, the options for offshore development include a floating production and storage offloading facility (FPSO) as, for example, the Enfield oil development in the Carnarvon Basin, or building a production platform and piping the oil ashore, as at

the Cliff Head field in the Perth Basin. Where the pipeline infrastructure is well established, new crude oil discoveries can be rapidly brought on stream as in the inshore Carnarvon Basin. Onshore, the options are to link into or extend the oil pipeline network or, in cases of small remote fields, as at Blina in the Canning Basin, to transport the oil by road.

The production phase includes extracting oil from the reservoir and separating impurities. At the initial stage of extraction, the natural pressure of the subsurface reservoir is generally sufficient for the oil to flow to the surface. If the reservoir pressure is insufficient, an advanced recovery method is used to increase reservoir pressure.

Condensate is a component of natural gas and is produced during gas or crude oil field development. In some cases the condensate is extracted and the gas is reinjected in a process called gas recycling.

### Processing, transport, storage and trade

Crude oil and condensate is not generally used in its raw or unprocessed form, apart from some light-sweet crude oil with low sulphur content which can be used as a burner fuel for steam generation in industrial applications. The majority of crude oil is processed in a refinery to produce refined products, such as gasoline, diesel, aviation fuel, fuel oil,

#### BOX 3.1 PETROLEUM SYSTEMS AND RESOURCE PYRAMIDS

Oil accumulations are the products of a 'petroleum system' (Magoon and Dow 1994). The critical elements of a petroleum system are:

- source – an organic rich rock, such as an organic rich mudstone;
- reservoir – porous and permeable rock, such as sandstone;
- seal – an impermeable rock such as a shale or mudstone;
- trap – a sub-surface structure that contains the

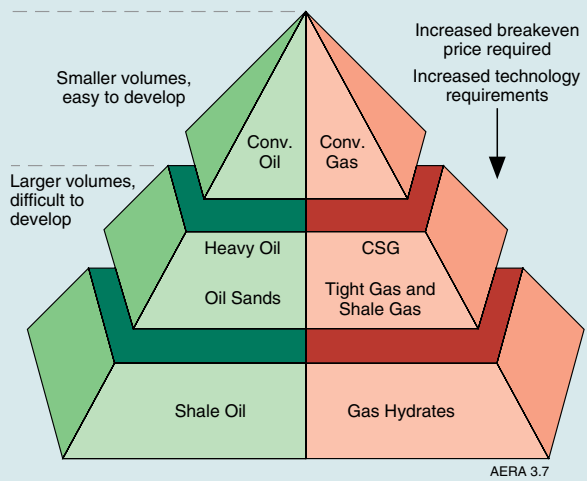
- accumulation, such as a fault block or anticline;
- overburden – sediments overlying the source rock required for its thermal maturation; and
- migration pathways to link the mature source to the trap (figure 3.6).

In addition to these static elements, the actual processes involved – trap formation, hydrocarbon generation, expulsion, migration, accumulation and preservation – must occur, and in the correct order, for the petroleum system to successfully operate and for oil accumulations to be formed and preserved. It is essential that the source rock has been through (or is still within) the oil window, the zone in the subsurface where temperatures are sufficient for thermal alteration of the organic matter to oil. At higher temperatures, below the bottom of the oil window, oil starts to be broken down (cracked) to gas.

Unconventional oil accumulations reflect the failure or under-performance of the petroleum system. Oil shale is an example where a thermally immature source rock has not generated and expelled hydrocarbons. Oil or tar sands occur where conventional crude oil has failed to be trapped at depth and has migrated near to the surface and has become degraded by evaporation, biodegradation and water washing to produce a viscous heavy oil residue.

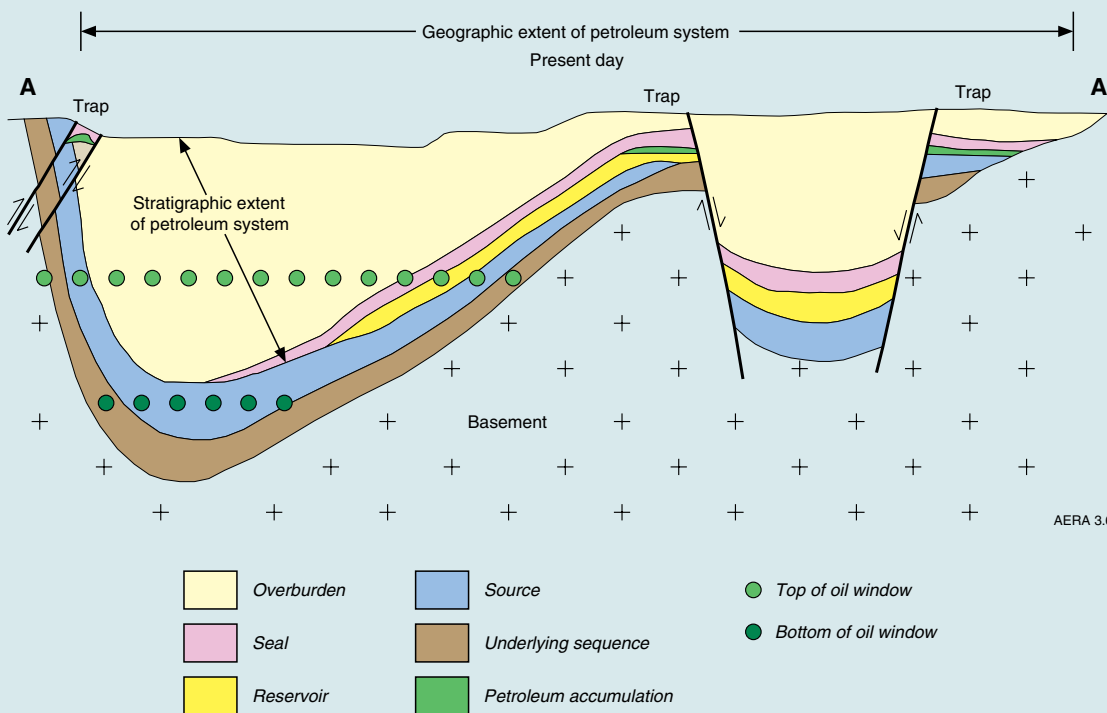
The petroleum resource pyramid (McCabe 1998) describes how a smaller volume of easily extracted conventional gas and oil is underpinned by larger volumes of more difficult and more costly to extract

unconventional gas and oil (figure 3.7). For the unconventional hydrocarbon resources, additional technology, energy and capital has to be applied to extract the gas or oil, replacing the natural action of the geological processes of the petroleum system. Technological developments and rises in price can make the lower parts of the resource pyramid accessible and economic to produce. The recent development of oil sands in Canada and of shale gas in the United States are examples where rising energy prices and technological development has facilitated the exploitation of unconventional hydrocarbon resources lower in the pyramid.



**Figure 3.7** Petroleum Resource Pyramid

Source: Geoscience Australia (adapted from McCabe 1998 and Branan 2008)



**Figure 3.6** Petroleum system elements

Source: Magoon and Dow 1994 (modified)

kerosene and LPG. Some crude oil and condensate can also be converted into non-energy products and used as a feedstock in the petrochemical industry.

Once refined, end-use products can be stored and transported to the demand centre via road, rail, sea or pipeline.

Around 70 per cent of Australia's crude oil and condensate production occurs off the north-west coast. Around 60 per cent of this production is exported, reflecting the proximity to refineries in south-east Asia. In 2008–09, approximately 63 per cent of Australia's refinery input requirements were imported. This partly reflects the insufficient crude oil and condensate production in eastern Australia, particularly within reasonable distance of refineries in Sydney and Brisbane.

In 2008–09, around 40 per cent of Australia's refined petroleum products were imported, primarily reflecting increasing dependence on overseas

refineries to meet incremental domestic refined product demand. Some 8 per cent of Australia's refinery production was exported, mainly in the form of transport fuels for international carriers.

### End use market

The major end-use market for refined products is the transport sector. Refined petroleum products are transported to local distribution points, from where they are delivered either directly to end users or to retail outlets, predominately as petrol, diesel and LPG.

### 3.2.3 World oil market

Table 3.1 provides a snapshot of the Australian oil market within a global context. Australia's reserves account for only a small share of global reserves, and Australia is a relatively small producer and consumer.

### Oil reserves and production

World proven oil reserves were estimated to be around 1.4 trillion barrels (equivalent to around 8.3 million PJ), at the end of 2008 (table 3.1). This

**Table 3.1** Key oil statistics, 2008

	unit	Australia 2007–08	Australia 2008	World 2008
<b>Reserves</b>	PJ	-	24 284	8 257 028
	Bbbl	-	4.2	1408
Share of world	%	-	0.3	100
<b>Production of crude oil, condensate and LPG</b>	PJ	1059	-	174 012
	mmbbl	187	194	30 471
Share of world	%	-	0.6	100
Average annual growth from 2000	%	-4.3		1.3
<b>Oil refining capacity</b>	kb/d	-	734	88 627
Share of world	%	-	0.8	100
<b>Consumption of crude oil, condensate and LPG</b>	PJ	1417	-	-
Average annual growth from 2000	%	-2.4	-	-
<b>Consumption of oil and oil products</b>	PJ	1942	-	171 236 <sup>a</sup>
	mmbbl	-	342	31 586 <sup>a</sup>
Share of world	%	-	1.1	100
Share of primary energy consumption	%	33.6	-	34.0
Average annual growth from 2000	%	1.3	-	1.6
<b>Imports of crude oil and other refinery feedstocks</b>	PJ	1019	-	98 392 <sup>a</sup>
Average annual growth from 2000	%	-0.3	-	1.8
<b>Imports of oil and oil products</b>	PJ	1678	-	139 109 <sup>a</sup>
	kb/d	762	771	67 277 <sup>a</sup>
	mmbbl	278	282	24 556 <sup>a</sup>
Share of world	%	-	1.1	100
Average annual growth from 2000	%	4.2	-	2.6
<b>Exports of crude oil, condensate and LPG</b>	PJ	661	-	92 842 <sup>a</sup>
Average annual growth from 2000	%	-3.0	-	-
<b>Exports of oil and oil products</b>	PJ	807.7	-	135 742 <sup>a</sup>
Average annual growth from 2000	%	-2.6	-	-

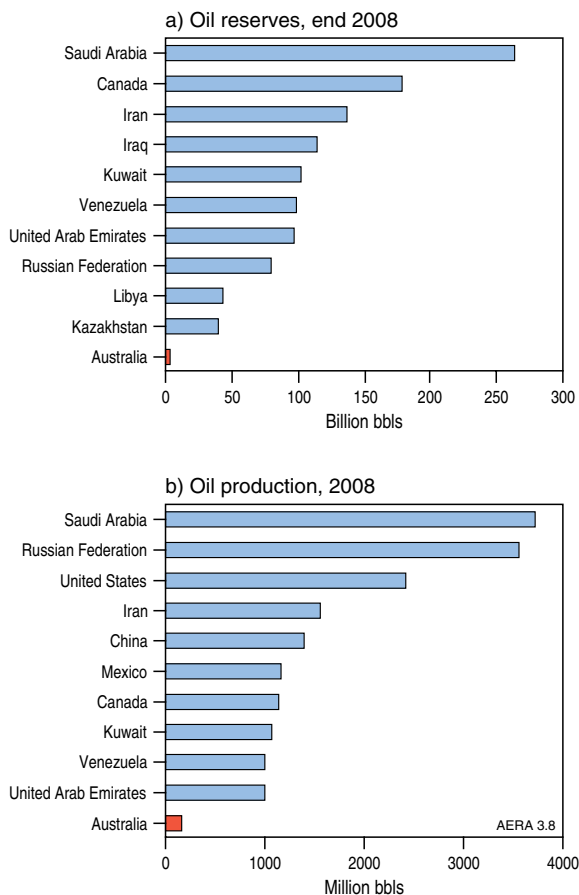
**Note:** Bbbl – billion barrels, mmbbl – million barrels, kb/d – thousand barrels a day  
a 2007 data

**Source:** ABARE 2009b; BP 2009a; IEA 2009a, b

amount could be increased in the future if unproved oil reserves and resources can be upgraded to proven reserves (oil considered to be recoverable with reasonable certainty under current economic and operating conditions). At current rates of world production, the estimated proven oil reserves are enough to last for around 42 years. Since the mid-1980s the global reserves to production ratio has been steady at around 40 years or more (BP 2009a) as production is balanced as new discoveries are made and new reserves are developed each year.

About two-thirds of total world reserves are located in the Middle East. Four of the five countries with the world's largest reserves – Saudi Arabia, Iran, Iraq and Kuwait – are in this region (figure 3.8). Saudi Arabia alone accounted for 19 per cent (1 552 320 PJ, 264 Bbbl) of world reserves. Canada has the second largest share of world oil reserves, though oil sands totalling some 887 880 PJ (151 Bbbl) account for around 80 per cent of these reserves. The Asia Pacific region accounted for 3 per cent of world oil reserves. The largest oil reserves in this region are located in China.

Australia is ranked twenty-seventh in the world in terms of proven oil reserves, accounting for around 0.3 per cent of global reserves.



**Figure 3.8** World oil reserves and production, major countries, 2008

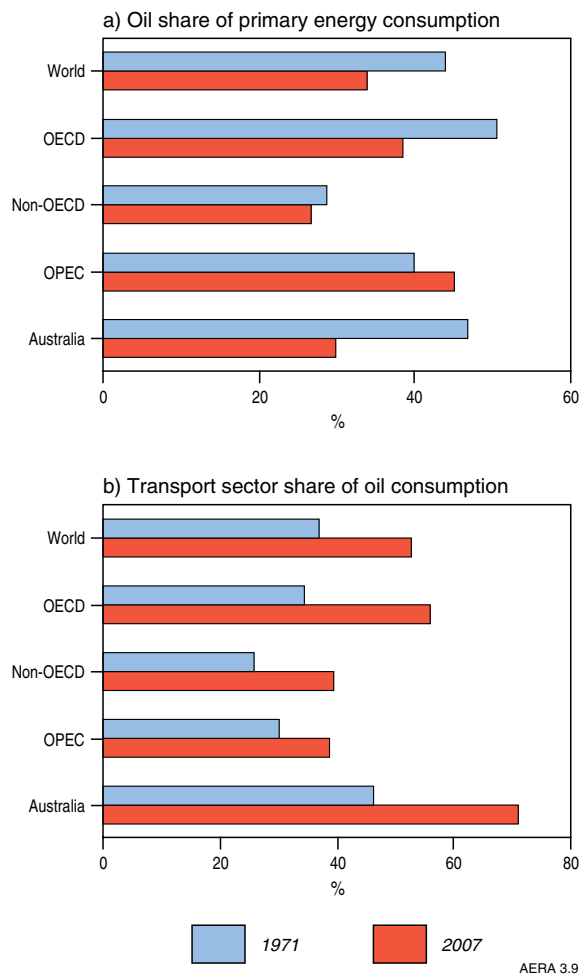
Source: BP 2009a; IEA 2009a

World total oil production in 2008 was some 30.5 Bbbl (equivalent to around 174 012 PJ). Production of crude oil represents more than 90 per cent of total oil production, which includes crude oil, condensate, LPG and unconventional oil. The major oil producers are located in the Middle East, with a 31 per cent share of world production. Saudi Arabia is the largest single producer, accounting for around 13 per cent of world production (figure 3.8). The Russian Federation is also a major producer (12 per cent). Other Former Soviet Union countries (particularly Azerbaijan, Kazakhstan and Turkmenistan) and Africa (particularly Angola and Sudan) are also becoming important oil producing regions. Over the period 2000 to 2008, production from these two regions grew at an average annual rate of around 7 per cent and 5 per cent respectively.

Australia is only a small oil producer, accounting for 0.6 per cent of total oil production in 2008.

### Petroleum refining

Because virtually all oil, conventional and unconventional, needs to be processed before end use, refinery capacity and throughput are significant



**Figure 3.9** Oil share of total energy consumption and transport sector usage

Source: IEA 2009a; 2009b

**Table 3.2** World refinery capacities and petroleum production, 2008

	Refinery capacities (kb/d)	Share of world capacity (%)	Refinery output (kb/d)	Share of world production (%)
Asia Pacific	25 098	28.3	22 653	28.0
North America	21 035	23.7	21 567	26.7
Europe	17 007	19.2	16 071	19.9
Former Soviet Union	8079	9.1	6172	7.6
Middle East	7592	8.6	6493	8.0
Latin America	6588	7.4	5434	6.7
Africa	3228	3.6	2466	3.0
<b>World</b>	<b>88 627</b>	<b>100.0</b>	<b>80 856</b>	<b>100.0</b>
<b>Australia</b>	<b>734</b>	<b>0.8</b>	<b>684</b>	<b>0.8</b>

**Note:** Includes capacity and production from unconventional oil

**Source:** BP 2009a; IEA 2009a

indicators of supply of end use products. Table 3.2 summarises world refining capacity and production, by region.

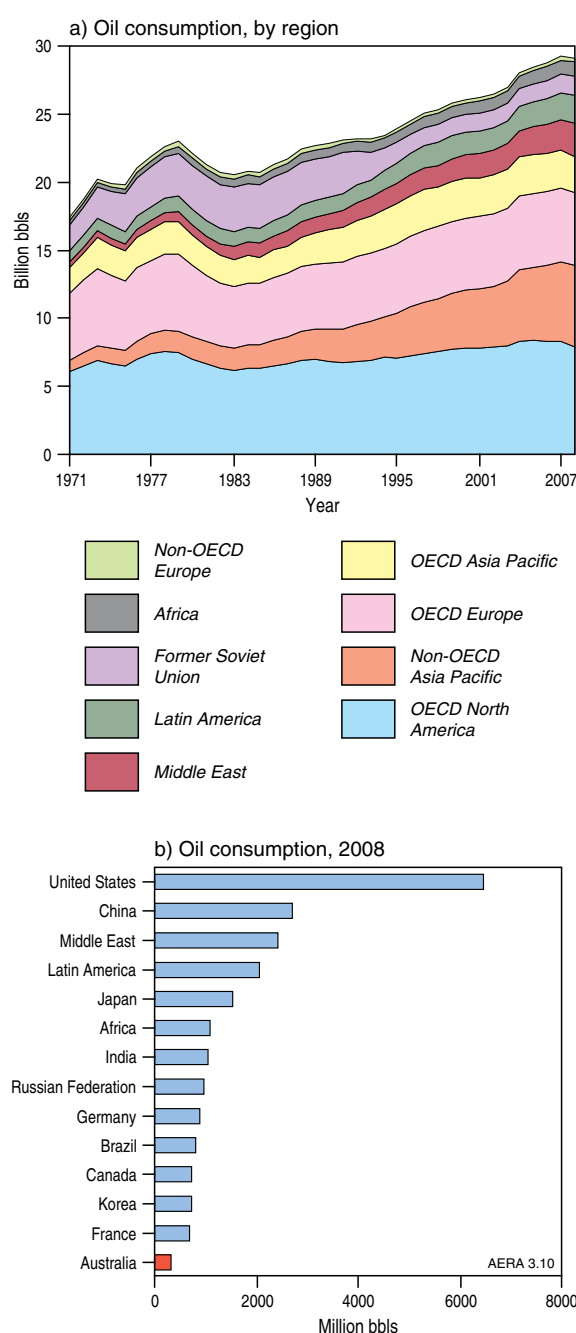
The largest share, accounting for around 28 per cent of world refinery capacity and output, is in the Asia Pacific region. China, Japan, India and the Republic of Korea are the major producers of refined products in the region, although Japan and the Republic of Korea rely almost entirely on imported crude oil. The largest single producer is the United States, accounting for more than 20 per cent of world production of oil products. Australia accounted for less than 1 per cent of world refining capacity and production.

### Consumption

Oil is an important energy source, currently accounting for around 34 per cent of world primary energy requirements. However, its share of primary energy has been declining steadily since the 1970s from around 45 per cent (figure 3.9). World oil consumption grew at a moderate rate of around 1.5 per cent per year between 1971 and 2008 whereas primary energy consumption grew at 2.2 per cent per year over the same period.

More than 50 per cent of world oil consumption is currently used in the transport sector, compared with less than 40 per cent in the early 1970s (figure 3.9). In contrast, the global shares of oil consumption in the industry and electricity generation sectors have been steadily declining over the past twenty years. In 2007, the industry and electricity generation sectors accounted for 8 per cent and 7 per cent respectively of total oil consumption. Around 14 per cent of world oil consumption is used as non-energy feedstock.

Figure 3.10 shows world oil consumption by region. North America and the Asia Pacific are the major consuming regions, responsible for nearly 60 per cent of world oil consumption in 2008. Oil consumption in non-OECD countries has grown more rapidly than the world average, at an average rate of 3 per cent per year between 1971 and 2008. The fastest growing oil consuming region is non-OECD Asia, growing at an

**Figure 3.10** World oil consumption

**Source:** IEA 2009a



**Table 3.3** World oil trade by region, 2008

Shares %	To							
	Asia Pacific	North America	Europe	Latin America	Africa	Australasia	unknown	World exports
<b>From</b>								
Middle East	63	18	19	8	60	12	11	37
Africa	8	19	22	27	7	1	0	15
Former Soviet Union	4	4	47	4	1	1	40	15
North America	1	31	5	42	2	2	6	11
Asia Pacific	19	1	1	12	4	80	8	10
Latin America	3	17	4	0	2	0	0	7
Europe	1	8	0	7	24	0	34	4
Australasia	1	0	0	0	0	0	0	1
Unknown	0	2	2	0	0	4	0	1
World imports	40	26	25	3	3	2	1	100

Source: BP 2009a

average rate of more than 5 per cent per year over the same period.

Australia is ranked twenty-second in the world in terms of oil consumption, accounting for around 1 per cent of the world total. Almost 70 per cent is consumed in the transport sector, while 8 per cent is used as non-energy feedstock.

### Trade

Given the significant separation of major producing and major consuming countries, there is a substantial level of trade in oil. Over the past twenty years oil trade has increased as oil production reserves in the Asia Pacific region and North America failed to keep pace with growth in demand. In the mid-1980s, around 40 per cent of world oil consumption was supplied through international trade. This increased to around 65 per cent in 2008.

World oil trade in 2008 was 67.3 million barrels per day (IEA 2009a). The largest export region was the Middle East, which accounted for around 37 per cent of world oil exports (table 3.3). Africa and the Former Soviet Union countries together accounted for 30 per cent of world oil exports. The largest importer of oil, the Asia Pacific region, accounted for around 40 per cent of world oil trade in 2008. North America and Europe together accounted for about half of world trade.

In 2008, around 63 per cent of Asia Pacific oil imports were sourced from the Middle East and regional trade within the Asia Pacific accounted for a further 19 per cent. In North America, 31 per cent of imports are sourced from within the region, specifically oil exports from Canada and Mexico to the United States. Significant quantities of oil are imported into North America from Latin America, the Middle East and Africa. The majority of the Europe's imports are sourced from the Former Soviet Union, Africa and the Middle East.

Australia is a net importer of crude oil and condensate and of refined oil products, but is a net exporter of LPG. Since the mid-1990s, Australia's imports of crude oil from the Middle East have been gradually declining and have been increasingly sourced from South-East Asia, mainly from Vietnam.

### World oil market outlook

In its reference scenario, the IEA projects world demand for primary oil – and the supply to meet that demand – to both grow by 1 per cent per year, from 29 645 mmbbl (169 297 PJ) in 2008 to 36 820 mmbbl (210 271 PJ) in 2030 (table 3.4).

Oil demand in non-OECD economies is expected to grow at a faster rate than in OECD economies. By 2030, non-OECD economies are expected to represent more than half of world oil demand, up from 41 per cent in 2008.

The majority of the increase is expected to be supplied by OPEC countries, where significant proven reserves of conventional crude oil exist. OPEC's share of world oil supply could increase from around 44 per cent in 2008 to 52 per cent in 2030.

Some 52 per cent of the oil was used in the transport sector in 2008. This share is expected to rise further to 57 per cent in 2030. Viable alternatives for transport fuels are expected to remain relatively limited throughout the outlook period, while the share of oil use in other sectors, including industry and electricity generation, is expected to decline further.

Production of conventional oil, including crude oil and condensate, is expected to slow towards the end of the outlook period. To meet oil demand, increased production is expected to come from unconventional sources, mainly oil sands, extra-heavy oil, gas-to-liquids and coal-to-liquids. As a result, the share of unconventional oil is expected to rise from 2 per cent in 2008 to 7 per cent in 2030.

**Table 3.4** World oil outlook from IEA reference case<sup>a</sup>

	unit	2008	2030
<b>World oil supply</b>	<b>PJ</b>	<b>169 097</b>	<b>210 271</b>
	mmbbl	29 610	36 820
Share of OPEC supply	%	43.7	52.2
Share of supply from unconventional oil	%	2.1	7.0
Annual growth 2008–30	%		1.0
<b>World primary oil demand</b>	<b>PJ</b>	<b>169 297</b>	<b>210 271</b>
	mmbbl	29 645	36 820
Share of non-OECD demand	%	41.3	53.4
Share of transport sector demand	%	52.0	57.0
Annual growth 2008–30	%		1.0

<sup>a</sup> Data are converted from million barrels per day to million barrels by multiplying with 350, factor that is consistent with BP (2009a).  
**Source:** IEA 2009c

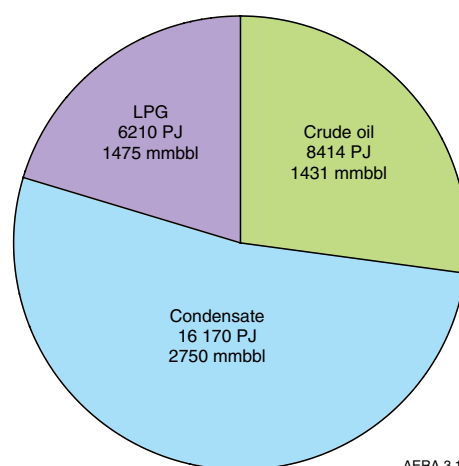
The IEA projects world demand for energy to grow more slowly under its 450 scenario in which countries take coordinated action to restrict the rise in global temperatures to 2°C and stabilise the greenhouse gases in the Earth’s atmosphere to around 450 parts per million carbon dioxide-equivalent (IEA 2009c). Under this scenario the IEA projects oil demand to grow at an average rate of 0.2 per cent per year to reach 31 240 mmbbl in 2030 (down 15 per cent on the reference case). In the IEA’s 450 scenario demand growth is driven primarily by China (averaging 2.7 per cent per year) and to a lesser extent other developing countries while demand reduces in the United States and other OECD countries. In this scenario the IEA predicts savings in transport fuel consumption through efficiencies and greater use of electric and hybrid vehicles and a greater contribution from second-generation biofuels after 2020 (IEA 2009c).

### 3.3 Australia’s oil resources and market

#### 3.3.1 Crude oil resources

Australia’s crude oil resources were estimated at 8414 PJ (1431 mmbbl) as at 1 January 2009. Crude oil represents 27 per cent of liquid petroleum resources with the remainder being made up of condensate (16 170 PJ, 53 per cent) and naturally-occurring LPG (6210 PJ, 20 per cent) (figure 3.11).

As shown in table 3.5, most of Australia’s identified crude oil resource is in the economic demonstrated resource (EDR) category and only a small volume is considered sub-economic given current relatively high oil prices.



AERA 3.11

**Figure 3.11** Australia’s liquid petroleum resources by energy content and volume as at 1 January 2009**Source:** Geoscience Australia 2009a

Resource classification is more fully discussed in Appendix D, but note that EDR are resources with the highest levels of geological and economic certainty and include remaining proved plus probable commercial reserves of petroleum. Sub-economic Demonstrated Resources (SDR) are resources for which profitable extraction has not yet been established. Inferred Resources are those with a lower level of confidence that have been inferred from more limited geological evidence and assumed but not verified.

An additional but uncertain resource is represented by the volumes of crude oil that could be produced from existing fields by the application of enhanced oil recovery (EOR) technologies such as miscible gas flooding (e.g. using nitrogen or carbon dioxide). These methods can increase the oil recovery factor significantly beyond the 30–50 per cent typically recovered using combined primary and second recovery methods. However, EOR depends heavily on the availability and cost of miscible gases (Wright et al. 1990) and is not currently undertaken at any Australian oil field. Reserves growth (Geoscience Australia, 2001, 2004, 2005) in existing fields is another potential source of additional crude oil resources.

**Table 3.5** Australian crude oil resources represented as McKelvey classification estimates as at 1 January 2009

Crude Oil Resources	PJ	mmbbl
Economic Demonstrated Resources	6950	1182
Sub-economic Demonstrated Resources	1464	249
<b>Total</b>	<b>8414</b>	<b>1431</b>

**Source:** Geoscience Australia 2009a

Most (72 per cent) of the remaining identified crude oil resource is located in the Carnarvon (4839 PJ) and Bonaparte (1205 PJ) basins. Despite its 40 years of production, the Gippsland Basin remains a significant resource (1700 PJ) with smaller volumes in a number of onshore (Cooper-Eromanga, Bowen-Surat and Amadeus) and offshore (Browse, Perth and Bass) basins (figure 3.12).

While crude oil resources are identified across nine basins and through much of the stratigraphic column the significant volumes are restricted to the offshore Mesozoic basins on the northwest margin and in Bass Strait. The onshore basins contribute only about 5 per cent of the total crude oil resources.

Australia's remaining identified crude oil resources are dwarfed by past production which has come mainly from a few super-giant fields in the Gippsland Basin and the Barrow Island field in the Carnarvon Basin, all discovered in the 1960s (figure 3.13). Many such smaller oil fields have been found since, mostly in the Carnarvon and Bonaparte basins. The impact of these initial discoveries on crude oil resources and the reserves to production ratio is illustrated in figures 3.14 and 3.15.

The reserves to production (R/P) ratio has been relatively steady at around 7 to 10 years since the

1980s. However, it must be recognised that both production volumes and reserves have declined markedly in recent years. To date, around 80 per cent of the crude oil reserves discovered in Australia have been produced.

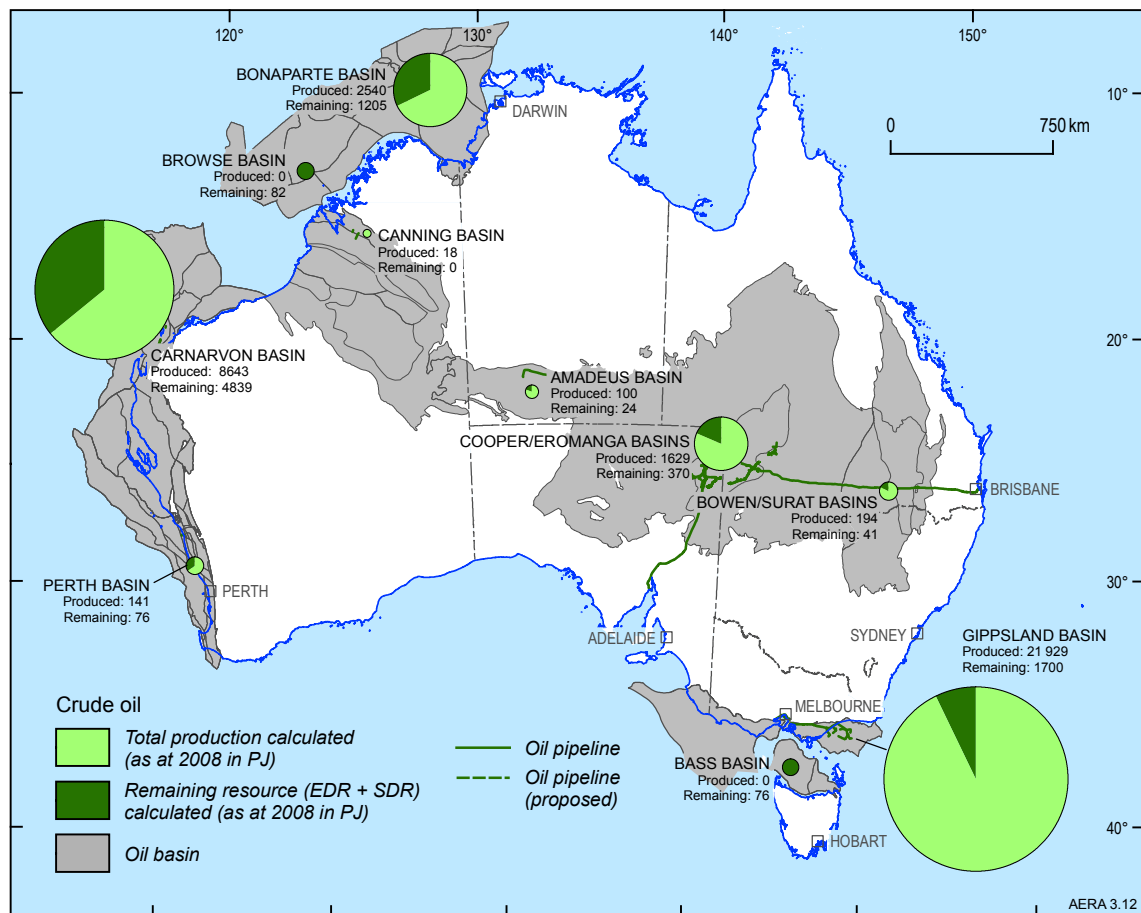
### 3.3.2 Condensate resources

Condensate exists as a hydrocarbon gas in the sub-surface reservoir that condenses to a light oil at the surface when a gas (or a gas and oil) accumulation is produced. Condensate now represents more than half of Australia's remaining liquid hydrocarbon resources. In 2008 the demonstrated condensate resource totalled 16 170 PJ (2750 mmbbls) most of which was assessed as EDR (table 3.6).

**Table 3.6** Australian condensate resources represented as McKelvey classification estimates as at 1 January 2009

Condensate Resources	PJ	mmbbl
Economic Demonstrated Resources	12 560	2136
Sub-economic Demonstrated Resources	3610	614
<b>Total</b>	<b>16 170</b>	<b>2750</b>

Source: Geoscience Australia 2009a



**Figure 3.12** Australia's known crude oil resources, by basin and oil pipelines

Source: Geoscience Australia

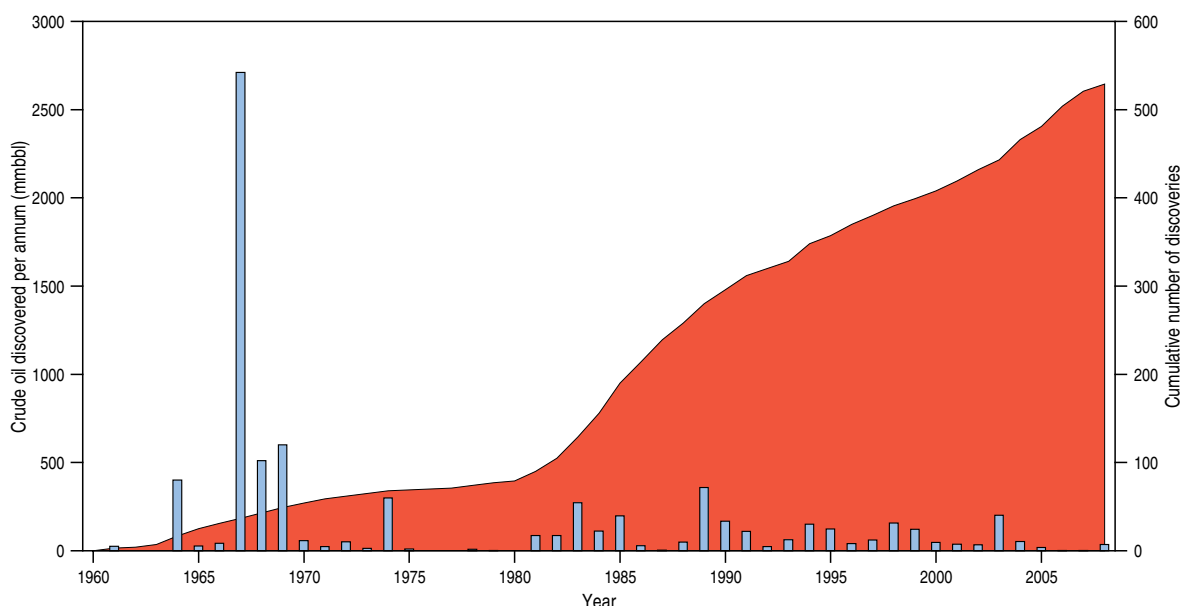
As most Australian crude oils are light, sweet crudes and are very similar to the condensate produced from gas fields, both are considered to have equivalent energy value per volume (5.88 PJ/mmbbl) in this report.

Condensate resources are located across ten basins, but the offshore basins along the North West Shelf – Bonaparte, Browse and Carnarvon – contain 92 per cent of the resource (figure 3.16). Similarly, the bulk of this resource is contained in a small number of giant ‘wet’ gas fields. The undeveloped Ichthys gas resource in the Browse Basin, for example, is estimated to contain 3099 PJ (527 mmbbls) or 19 per cent of Australia’s condensate resources; and is

the largest liquid hydrocarbon resource found since the Bass Strait oil fields in the Gippsland Basin in the 1960s.

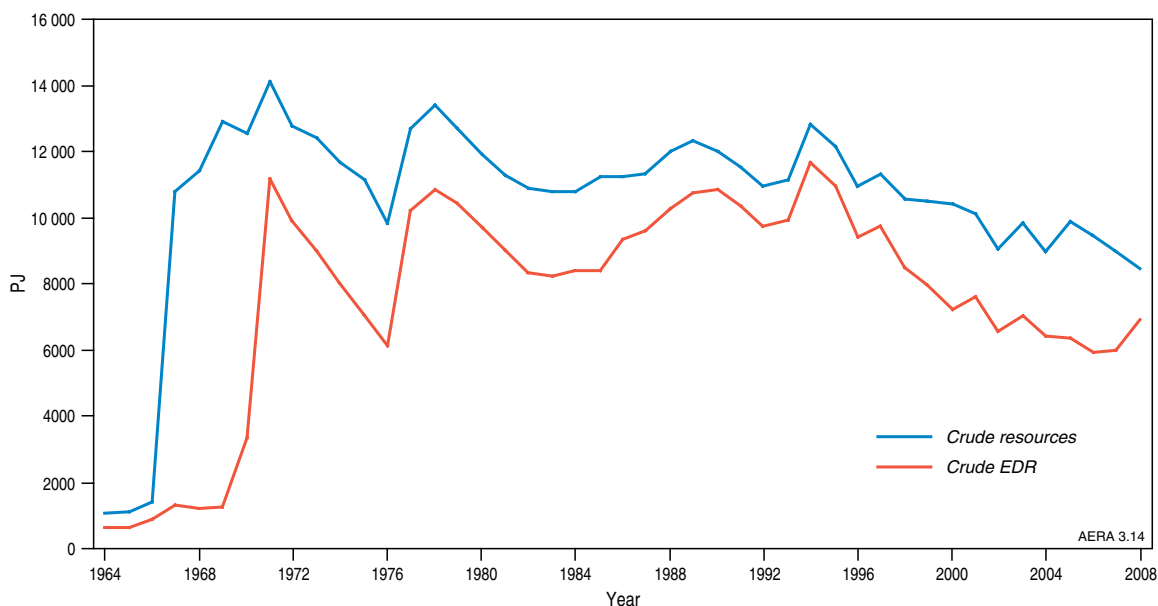
Proportionally the Carnarvon Basin gas fields tend to be leaner in condensate than those in the Browse and Bonaparte basins due to the dominance of the super-giant dry gas accumulations of Ito-Ito and Scarborough.

The identified condensate resource has an energy content that is less than 10 per cent that of the associated gas resource, but has strategic importance as it constitutes more than half of



**Figure 3.13** Australia’s crude oil discoveries, annual discovered volume (blue columns) and cumulative number of discoveries, 1960–2008

Source: Geoscience Australia

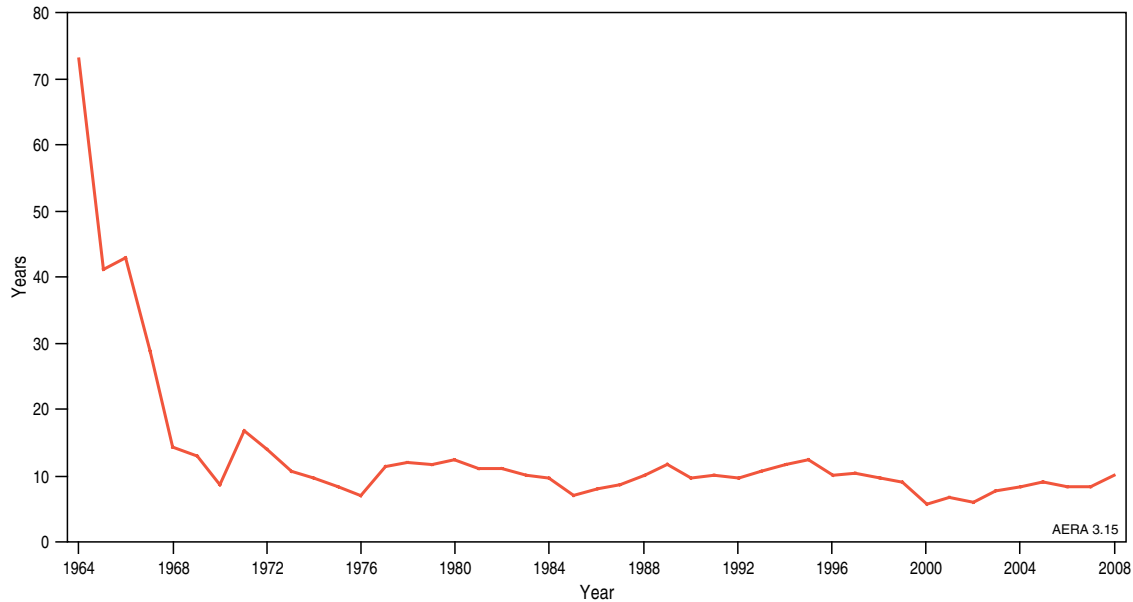


**Figure 3.14** Australian crude oil resources and economic demonstrated resources (EDR), 1964–2008

Source: Geoscience Australia

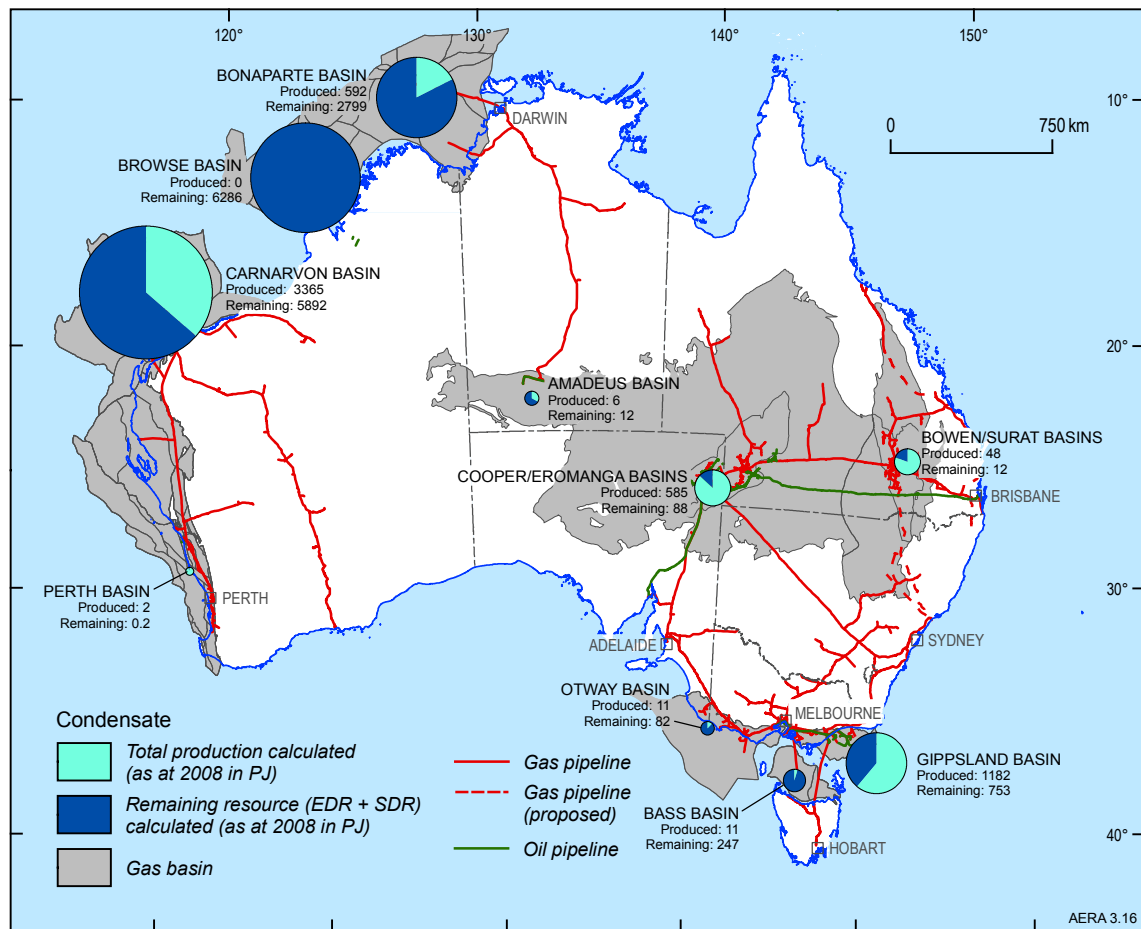
Australia's liquid fuel resource. Access to this resource requires development of the giant wet gas fields which in several cases also contain considerable volumes of carbon dioxide (CO<sub>2</sub>).

Australia's condensate resources have grown substantially since the discovery of the super-giant and giant gas fields along the North West Shelf in the early 1970s (North Rankin in the Carnarvon Basin,



**Figure 3.15** Australian crude oil reserves to production ratio in years of remaining production, 1964–2008

Source: Geoscience Australia



**Figure 3.16** Australia's known condensate resources by basin, and gas and oil pipelines

Source: Geoscience Australia

Scott Reef (Torosa) in the Browse Basin, Sunrise in the Bonaparte Basin). The big step in the condensate EDR in 2008 (figure 3.17) is largely due to the promotion of Ichthys into this category.

The EDR to production ratio of condensate since 1980 has mostly been between 20 and 50 years, apart from a peak in the early 1980s (figure 3.18). In 2008 at current levels of production Australia had about 30 years of condensate reserves remaining.

### 3.3.3 LPG resources

The identified resource of naturally-occurring liquid petroleum gas (LPG) in 2008 was estimated at 6210 PJ (1475 mmbbls), most of which was

assessed as EDR (table 3.7). LPG represents 20 per cent of Australia’s liquid hydrocarbon resource in energy content terms. LPG is less energy dense than crude oil and condensate. Hence, though Australia’s naturally-occurring LPG now volumetrically exceeds the crude oil resource, the crude oil has a higher energy content (8414 PJ in 1431 mmbbls of crude oil, compared with 6210 PJ in 1475 mmbbls of LPG).

LPG is a mixture of light hydrocarbons that is normally a gas in subsurface reservoirs and at the surface. However, LPG is stored and transported as a liquid under pressure and forms part of Australia’s liquid fuel supply. In addition to the LPG occurring naturally in gas and oil fields, LPG is also produced during the refining of crude oil.

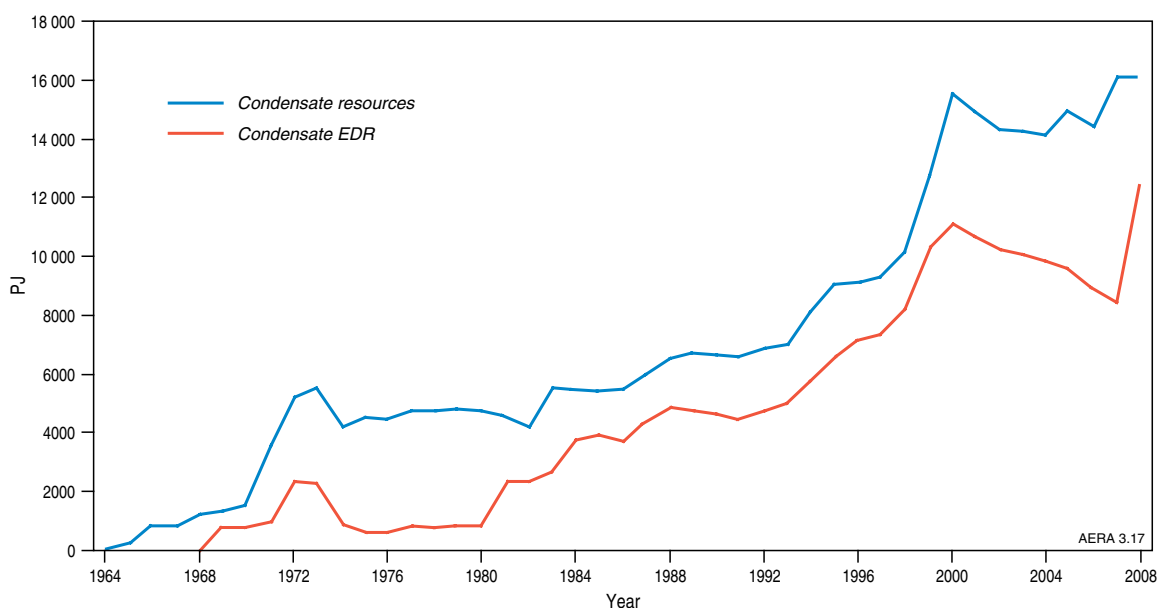


Figure 3.17 Australia’s identified condensate resources

Source: Geoscience Australia

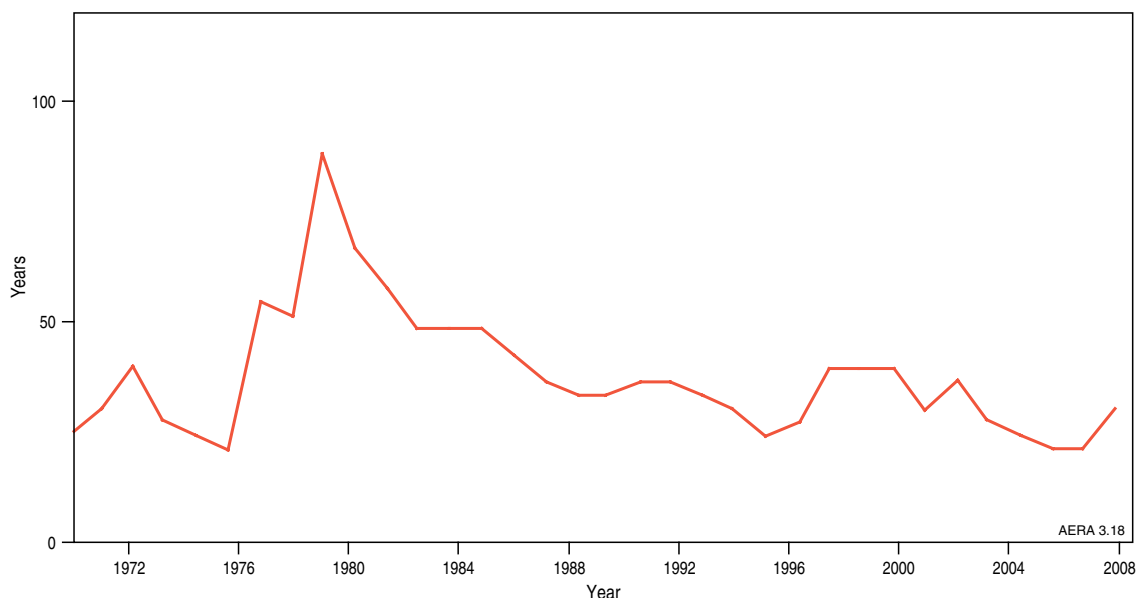


Figure 3.18 Condensate EDR to production ratio in years of remaining production

Source: Geoscience Australia



**Table 3.7** Australian naturally-occurring LPG resources represented as McKelvey classification estimates as at 1 January 2009

LPG Resources	PJ	mmbbl
Economic Demonstrated Resources	4613	1096
Sub-economic Demonstrated Resources	1597	379
<b>Total</b>	<b>6210</b>	<b>1475</b>

Source: Geoscience Australia 2009a

Naturally-occurring LPG resources are identified in eight basins (figure 3.19). The distribution of LPG is similar to that of condensate with the Carnarvon, Browse and Bonaparte basins again dominating (85 per cent of the remaining resource). The resource in the Gippsland Basin remains significant (10 per cent of the total) even though this represents only about a quarter of the initial resource.

In 2008 at current levels of production, Australia had 20 years of naturally-occurring LPG remaining.

### 3.3.4 Shale oil resources

Australia has significant potential unconventional oil resources contained in oil shale deposits in several basins. Oil shale is essentially a petroleum source rock which has not undergone the complete thermal maturation required to convert organic matter to

oil. In addition, the further geological processes of expulsion, migration and accumulation which produce conventional crude oil resources trapped in subsurface reservoirs have not occurred. The unconventional shale oil resource can be transformed into liquid hydrocarbons by mining, crushing, heating, processing and refining, or by *in situ* heating, oil extraction and refining (box 3.2).

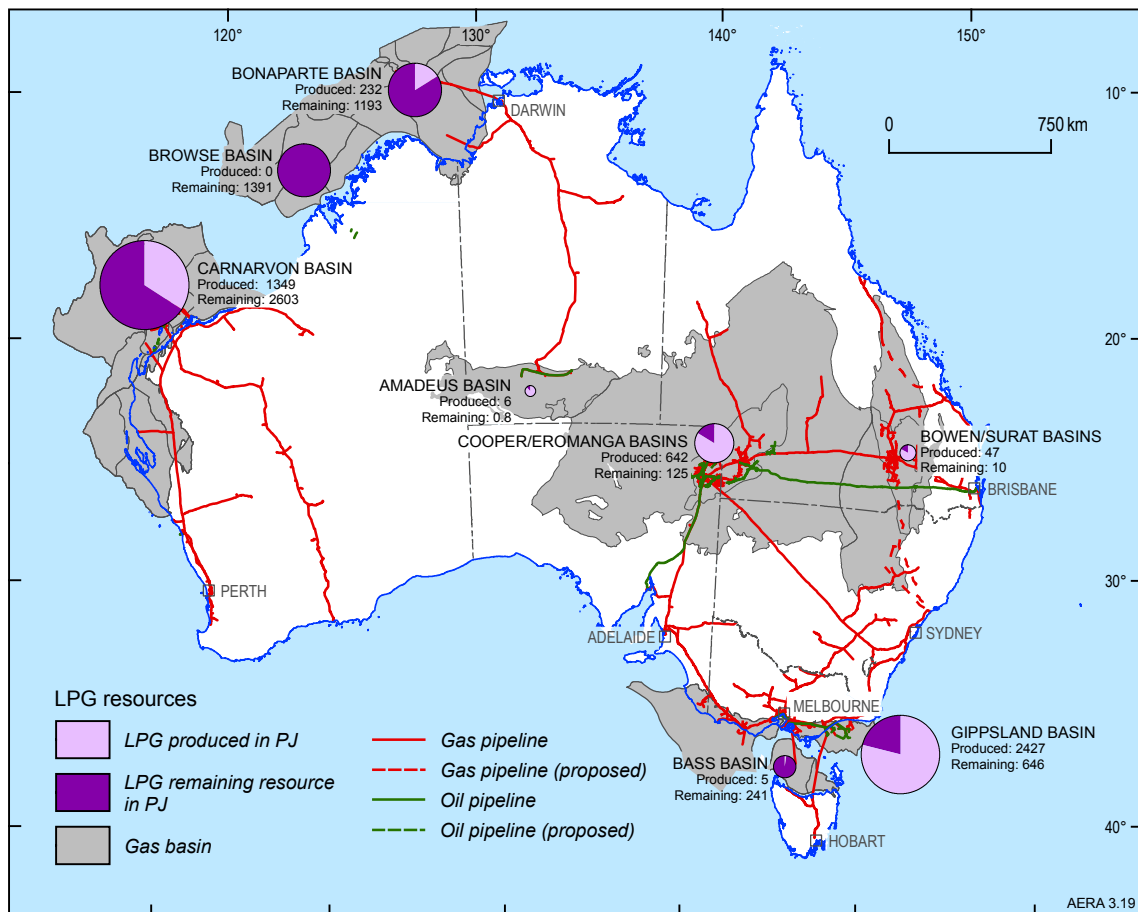
Australia's total identified energy resource contained in oil shale was estimated at 131 600 PJ (22 390 mmbbl) in 2009 (table 3.8). However, all of this was classified as either recoverable contingent (84 600 PJ, 14 387 mmbbl) or inferred (47 000 PJ, 8003 mmbbl) resources. This is a large unconventional oil resource.

**Table 3.8** Australian shale oil resources represented as McKelvey classification estimates as at 1 January 2009

Shale Oil Resources	PJ	mmbbl
Sub-economic Demonstrated Resources	84 600	14 387
Inferred Resources*	47 000	8 003
<b>Total</b>	<b>131 600</b>	<b>22 390</b>

\* The total inferred resource does not include a 'total potential' low grade shale oil resource of the Toolebuc Formation, Queensland estimated to be about 9 061 100 PJ (equivalent to 1 541 000 mmbbls, 245 000 GL) by BMR and CSIRO in 1983.

Source: Geoscience Australia 2009b



**Figure 3.19** Australia's LPG resources by basin

Source: Geoscience Australia

**BOX 3.2 SHALE OIL***Resources*

Oil shale is a significant but largely unutilised source of hydrocarbons (shale oil). Total world in-situ shale oil resources were estimated in 2005 (the last year for which world oil shale market data are available) to be around 16.62 million PJ (2826 billion bbl) in 27 countries (WEC 2007). Most of the resource is located in the Green River oil shale deposit in the United States. The USGS estimates the Green River oil shale to contain 1525 billion barrels of oil in-place in some seventeen oil shale zones (Johnson et al. 2009). Other countries with significant shale oil resources are the Russian Federation, the Democratic Republic of Congo, Brazil, Italy, Morocco, Jordan, Australia and Estonia. The total recoverable shale oil resource was estimated at about 6.27 million PJ (1067 Bbbl). Australia is estimated to have about 1.3 per cent of world recoverable shale oil resources.

*Production*

Small scale production of hydrocarbons (kerosene, lamp oil, fuel oil, and other products) from oil shale began in several countries in the late 1800s including Australia with production from the torbanite deposits at Joadja Creek near Lithgow and at Glen Davis (both in New South Wales) from 1865. This production continued through World War II until 1952. There was also production in the period 1910–34 from the Mersey River tasmanite deposits in Tasmania. Production in most western countries ceased after World War II because of the availability of cheaper supplies of conventional crude oil. However, production continued in Estonia, the then USSR, China and Brazil, peaking at 46 Mt of oil shale per year in 1980 (WEC 2007). Total recorded shale oil production in 2005 was about 5.014 mmbbl, comprising 2.529 mmbbl from Estonia, 1.319 mmbbl from China and 1.165 mmbbl from Brazil. In 2008 production of shale oil was limited to Estonia, China, and Brazil with several countries, including Israel, Morocco, Thailand and the United States, investigating the potential production of shale oil or use of oil shale in electricity generation (WEC 2009).

*Geology and extraction*

Oil shale deposits range in age from Cambrian to Cenozoic and were formed in a wide range of depositional environments ranging from freshwater and saline ponds and lakes commonly associated with coastal swamps (including peat swamps) to broad marine basins. Oil shales have a wide range of organic and mineral compositions and are classified according to their depositional environment, either terrestrial, lacustrine or marine. Terrestrial oil shales are composed mostly of resins and other lipid-rich (naturally-occurring molecules that include fats, waxes and sterols) organic matter and plant material. Lacustrine oil shales (known as lamosite

and torbanite) contain lipid-rich material derived from algae, whereas marine shales (tasmanite and marinite) are composed of lipid-rich derived from marine algae and other marine micro-organisms.

The organic matter in oil shale (which contains small amounts of sulphur and nitrogen in addition to carbon, hydrogen and oxygen) is insoluble in common organic solvents and is mixed with variable amounts of mineral matter, mostly silicate and carbonate minerals. There are currently two main methods for recovering oil from oil shale. The first involves mining (commonly by open-cut means) and crushing the shale, and then retorting (heating) it, typically in the absence of oxygen, to about 500°C. A large number of oil shale retorting technologies have been proposed but only a limited number are in commercial use. A second, more recent approach involves in-situ extraction of shale oil by gradually heating the rocks over a period of years to convert the kerogen. Both approaches rely on the chemical process of pyrolysis which converts the kerogen in the oil shale to shale oil (synthetic crude oil), gas and a solid residue. Conversion begins at lower temperatures but proceeds faster and more completely at higher temperatures.

Renewed interest in shale oil in recent years has prompted ongoing research into extraction technologies. A large number of technologies have been proposed and many trialled to produce shale oil. A report by the United States Department of Energy summarises those currently being investigated to produce shale oil (USDOE 2007). In-situ methods include injecting hot fluids (steam or hot gasses) into the shale formation via drill holes or heating using elements or pipes drilled into the shale with the heat conducted beyond the walls. Other approaches rely on heating volumes of shale using radio waves or electric currents. In-situ extraction has been reported to require less processing of the resultant fuels before refining but the process uses substantial amounts of energy. Both methods use substantial amounts of water and typically produce more greenhouse gases than does extraction of conventional crude oil. Currently over 30 companies in the United States are investing in the development of commercial-scale surface and in-situ processing technologies with several companies testing in-situ technologies to extract shale oil at more than 300 m depth (USDOE 2007).

*Australia*

There is no oil being extracted from oil shale in Australia. From 2000 to 2004, the Stage 1 demonstration-scale processing plant at the Stuart deposit near Gladstone in central Queensland produced more than 1.5 mmbbl of oil using a horizontal rotating kiln process (Alberta Taciuk

Process). No oil has been produced since 2004. The demonstration plant achieved stable production capacity of 6000 t of shale per day and oil yield totalling 4500 bbls per stream day while maintaining product quality and adhering to Environment Protection Authority emissions limits. The demonstration plant produced Ultra Low Sulphur Naphtha (ULSN), accounting for about 55 to 60 per cent of the output and Light Fuel Oil, about 40 to 45 per cent of output. The ULSN, which can be used to make petrol, diesel and jet fuel, had a very low sulphur content of less than 1 part per million.

Since acquiring the Stuart oil shale project, Queensland Energy Resources has undertaken a detailed testing program of processing of the

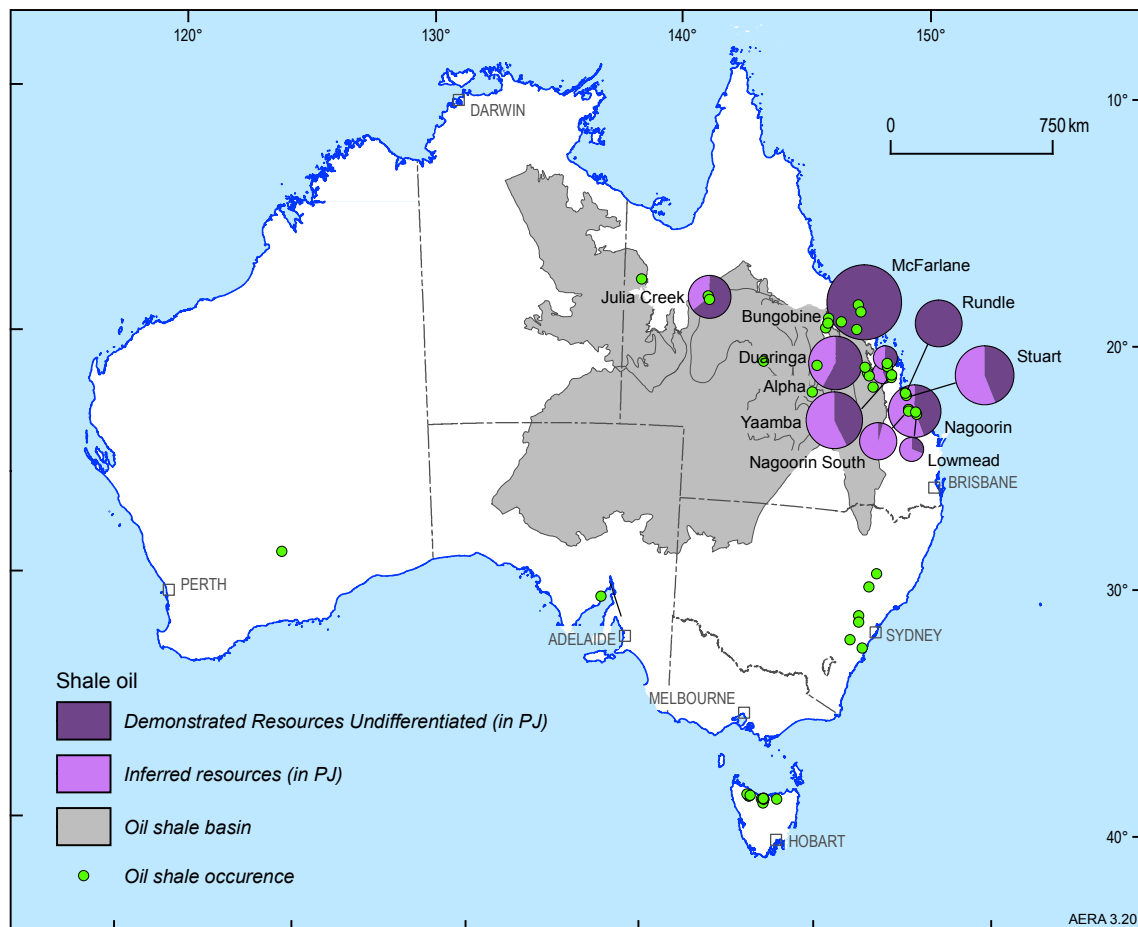
Queensland oil shale at a pilot plant in Colorado, United States and successfully demonstrated the use of the Paraho II vertical kiln technology to extract shale oil (WEC 2009). The company is currently examining a proposal for the construction of a small-scale technology demonstration plant at the Stuart site using the Paraho technology ([www.qer.com](http://www.qer.com)).

In 2008, the Queensland Government prohibited shale oil mining at the McFarlane (formerly Condor) deposit near Proserpine for 20 years. The Queensland Government is currently undertaking a two-year review on whether the oil shale industry should be developed in the state. Other Australian oil shale industry developments are summarised elsewhere (Geoscience Australia 2009b).

The majority of Australian shale oil resources of commercial interest are located in Queensland, in the vicinity of Gladstone and Mackay (figure 3.20). Thick Cenozoic lacustrine oil shale deposits (lamosite) of commercial interest are predominantly in a series of narrow and deep extensional basins near Gladstone and Mackay. From 1999 to 2003, oil was produced at a demonstration-scale processing plant (referred to as the Stuart Oil Shale Project) at the Stuart deposit

in the Narrows Basin, near Gladstone. The oil shales are graded from about 60 litres per tonne at zero per cent moisture (LTOM) to over 200 LTOM, comfortably above the 50 LTOM cut-off generally regarded as the minimum required for profitable operation.

Oil shale deposits of varying quality also occur in New South Wales, Tasmania, and Western Australia in sedimentary sequences of Permian, Cretaceous



**Figure 3.20** Distribution of Australian indicated shale oil resources

Source: Geoscience Australia

and Cenozoic age. There was some modest scale production from two of these deposits for periods up to the 1950s.

A potential shale oil resource of approximately 1 541 000 million barrels (9 061 086 PJ) was estimated for the Toolebuc Formation in north-western Queensland by the then Bureau of Mineral Resources (now Geoscience Australia) and the CSIRO (Ozimic and Saxby 1983). The Toolebuc Formation is very widespread but, at an average 37 LTOM, the resource is considered very low grade. It is not counted among the resources in table 3.8.

### 3.3.5 Total oil resources

Australia's oil resources are predominantly made up of conventional liquid hydrocarbons. Crude oil reserves are in decline, but there is a substantial remaining resource of condensate and naturally-occurring LPG associated with undeveloped offshore gas fields. Oil shale deposits contain a large, unconventional resource which does not currently add to Australia's liquid fuel supplies. Apart from

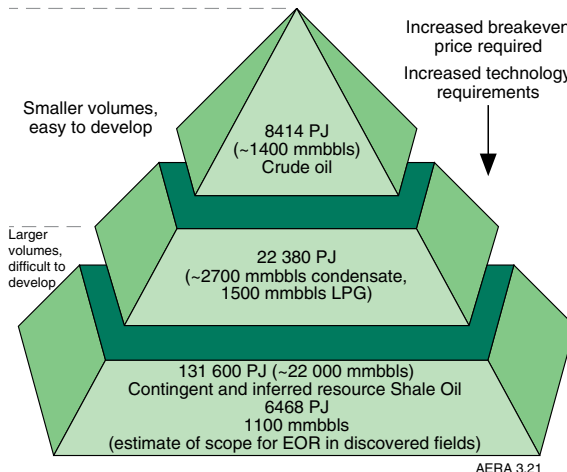


Figure 3.21 Australian oil resource pyramid

Source: Geoscience Australia (adapted from McCabe 1998 and Branran 2008)

enhanced oil recovery (EOR), options for future liquid fuel supply also include gas-to-liquids (GTL), coal-to-liquids (CTL) and biofuels which are discussed in other chapters in this assessment.

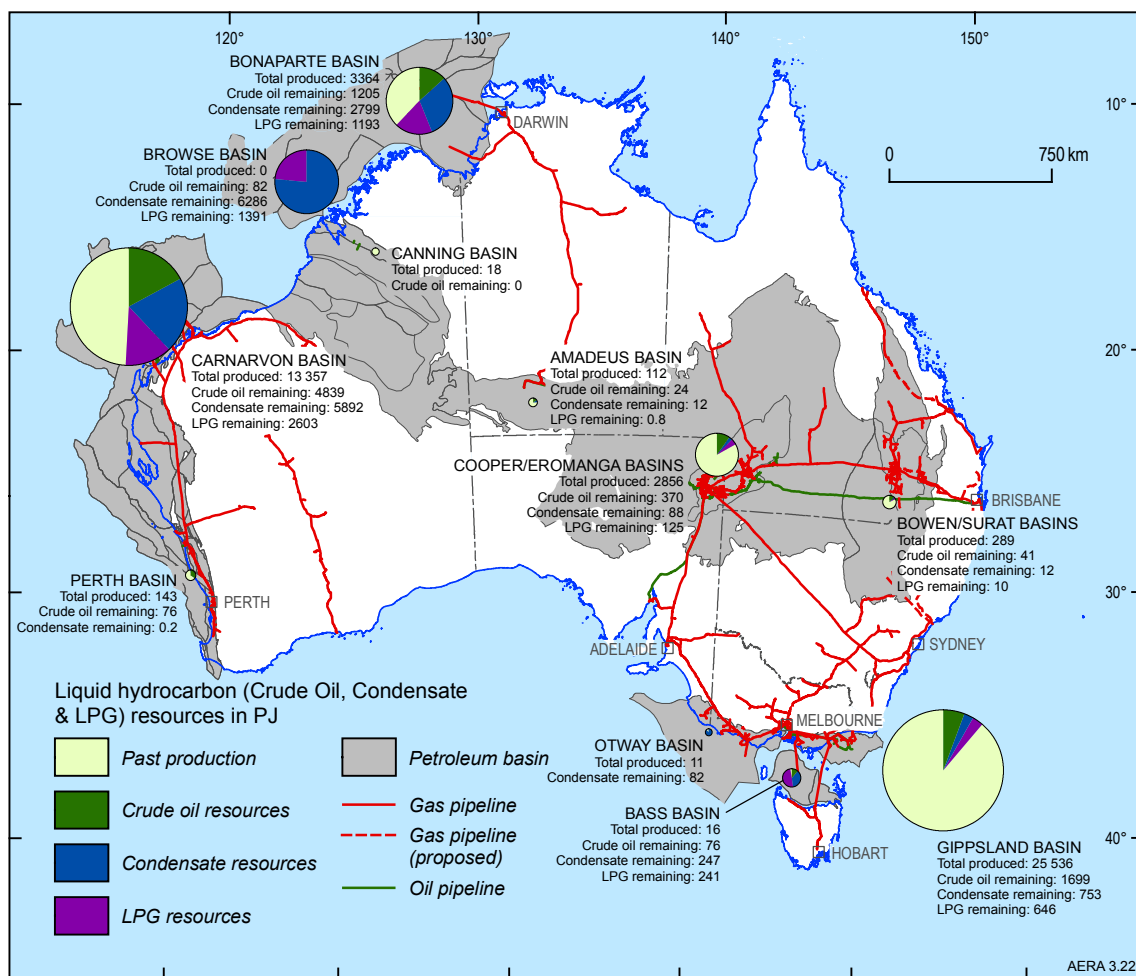


Figure 3.22 Australian crude oil, condensate and naturally-occurring LPG resources, infrastructure, past production and remaining resources

Source: Geoscience Australia

**Table 3.9** Crude oil, condensate and LPG McKelvey classification estimates by basin as at 1 January 2009

McKelvey Class.	Basin	Total energy	Crude Oil		Condensate		LPG	
		PJ	PJ	mmbbl	PJ	mmbbl	PJ	mmbbl
EDR	Carnarvon	12 464	4405	749	5457	928	2602	618
EDR	Browse	3957	0	0	3957	673	0	0
EDR	Bonaparte	4131	676	115	2264	385	1191	283
EDR	Gippsland	2626	1353	230	629	107	644	153
EDR	Other	945	516	88	253	43	176	42
<b>Total EDR</b>		<b>24 123</b>	<b>6950</b>	<b>1182</b>	<b>12 560</b>	<b>2136</b>	<b>4613</b>	<b>1096</b>
SDR	Carnarvon	868	434	74	434	74	0	0
SDR	Browse	3797	82	14	2327	396	1389	330
SDR	Bonaparte	1063	529	90	534	91	0	0
SDR	Gippsland	470	348	59	122	21	0	0
SDR	Other	473	71	12	193	32	209	49
<b>Total SDR</b>		<b>6671</b>	<b>1464</b>	<b>249</b>	<b>3610</b>	<b>614</b>	<b>1597</b>	<b>379</b>
<b>Total EDR + SDR</b>		<b>30 794</b>	<b>8414</b>	<b>1431</b>	<b>16 170</b>	<b>2750</b>	<b>6210</b>	<b>1475</b>

Source: Geoscience Australia 2009a

The resource pyramid (figure 3.21) highlights how a smaller volume of more readily accessible, high quality resources are underpinned by larger but less accessible resources. However, these unconventional oil resources come with development costs and risks. Technology, price and their own environmental impacts can influence access to them.

Conventional hydrocarbon liquid resources are located across ten basins but most remaining resources are in the Carnarvon, Browse and Bonaparte basins (table 3.9). The initial liquid resources of the Carnarvon Basin were nearly equivalent to those of the crude oil-rich Gippsland Basin (figures 3.22 and 3.12).

### 3.3.6 Oil market

#### Oil production

Most of Australia's current crude oil production is from the mature oil provinces – the Carnarvon and Gippsland basins – which in 2007–08 accounted for 62 per cent and 18 per cent respectively of crude oil production. The Gippsland Basin also accounts for almost half of Australia's naturally-occurring LPG production, although this has been declining steadily since production peaked in the mid-1980s (figure 3.23).

Australia's annual crude oil production progressively declined between 1985–86 and 1998–99 from 1102 PJ to 738 PJ (187.4 to 125.2 mmbbl, 29 794 to 19 905 ML). However, following the start-up of a number of new oil fields, including the Laminaria/Corallina, Elang/Kakatua and Cossack/Wanaea fields (all offshore north-western Australia), oil production increased rapidly, peaking at 1209 PJ (205.7 mmbbl, 32 704 ML) in 2000–01. Since then, crude oil production has declined at a rate of 7 per cent per year, to 697 PJ (117 mmbbl, 18 602 ML) in 2007–08.

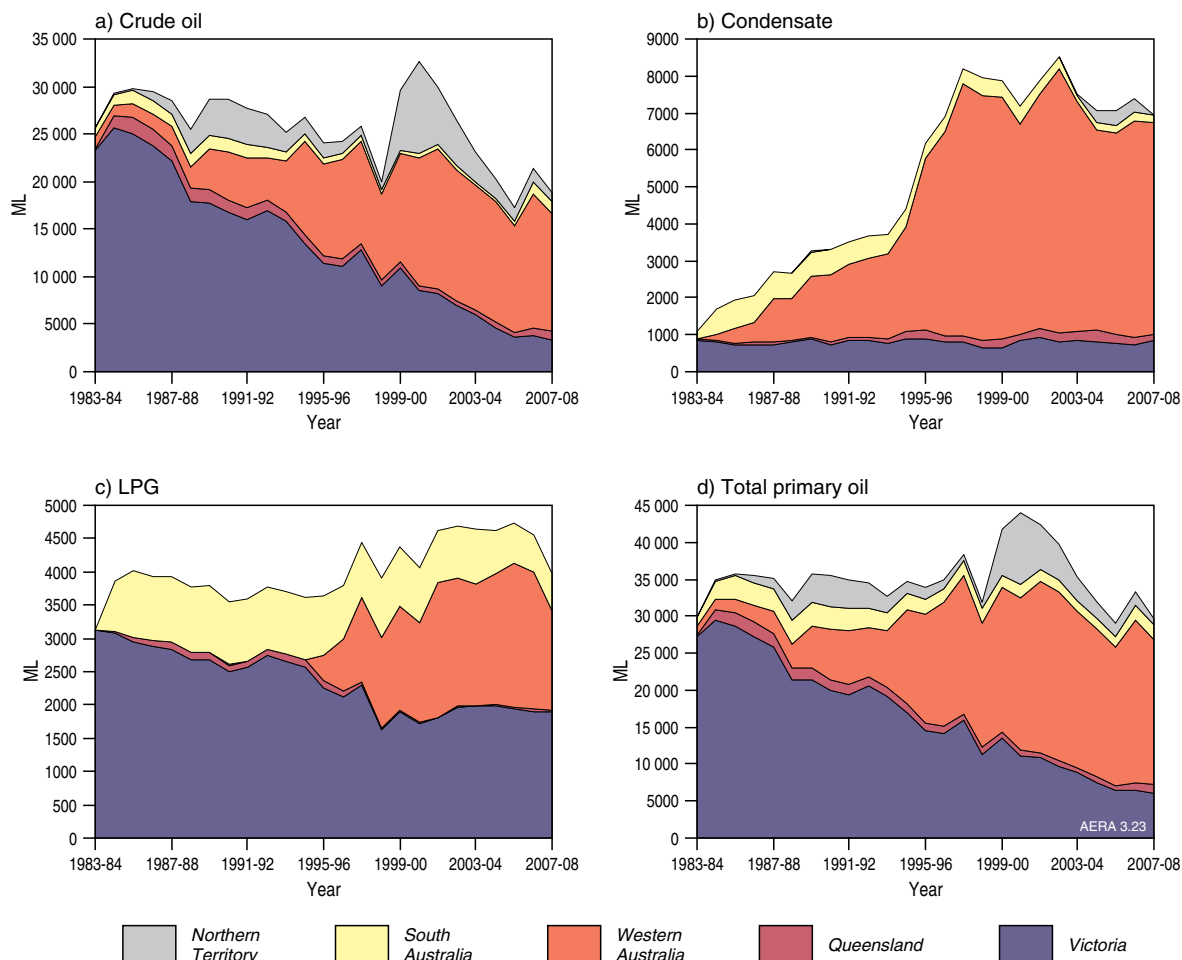
Domestic production of condensate increased from around 36 PJ (6.1 mmbbl, 1096 ML) in the first year of production in 1982–83 to 257 PJ (43.7 mmbbl, 6949 ML) in 2007–08, with production reaching 316 PJ (53.7 mmbbl, 8544 ML) in 2002–03. Naturally-occurring LPG production in Australia also increased from around 80 PJ (19 mmbbl, 3021 ML) in 1979–80 to 125 PJ (29.7 mmbbl, 4721 ML) in 2005–06, mainly from the Carnarvon Basin in Western Australia. In 2007–08, LPG production declined to 105 PJ (25.6 mmbbl, 4072 ML).

Over the past four years, a number of oil projects have been developed, with six fields in the Carnarvon Basin and one each in the Perth and Bonaparte basins. The eight fields have a production capacity in excess of 350 thousands of barrels per day (kbpd, table 3.10).

The Cliff Head development represents the first – and currently the only – offshore producing oil field in the Perth Basin. The Cliff Head field is modest in size (around 10 mmbbls), the accumulation's size having been revised downwards following further appraisal drilling. The decision to develop the field occurred during a period of rising oil prices that helped offset the impact of this appraisal drilling. The Enfield, Stybarrow and Vincent fields, all located in the deeper waters of the offshore Exmouth Sub-basin, Carnarvon Basin (figure 3.24), signal the addition of a significant new oil producing area for Australia: recoverable crude oil volumes across a dozen fields total around half a billion barrels.

In contrast to the nearly 6 billion barrels of conventional oil produced in Australia since the 1960s, only a few million barrels have been produced from oil shale. There was intermittent and small scale production from 1865 to 1952 when there was no indigenous conventional crude oil production. Another





**Figure 3.23** Australian oil production

Source: ABARE 2008

**Table 3.10** Crude oil and condensate projects recently completed, as at October 2009

Project	Company	Basin	Start up	Capacity	Capital Expenditure (\$m)
Cliff Head oil field	ROC Oil	Perth	2006	20 kbpd	285
Enfield oil field	Woodside Energy/Mitsui	Carnarvon	2006	100 kbpd	1480
Puffin oil field	AED Oil/Sinopec	Bonaparte	2007	30 kbpd	150
Woollybutt oil field South Lobe	Tap Oil	Carnarvon	2008	6–8 kbpd	143
Perseus-over-Goodwyn project	Woodside Energy	Carnarvon	2008	na	800
Stybarrow oil field	BHP Billiton/Woodside Energy	Carnarvon	2008	80 kbpd	874
Vincent oil field (stage 1)	Woodside Energy/Mitsui	Carnarvon	2008	100 kbpd	1000
Angel gas and condensate field	Woodside/BHP Billiton/BP/Chevron Texaco/Shell/Japan Australia LNG	Carnarvon	2008	310 PJ pa gas, 50 kbpd condensate	1400

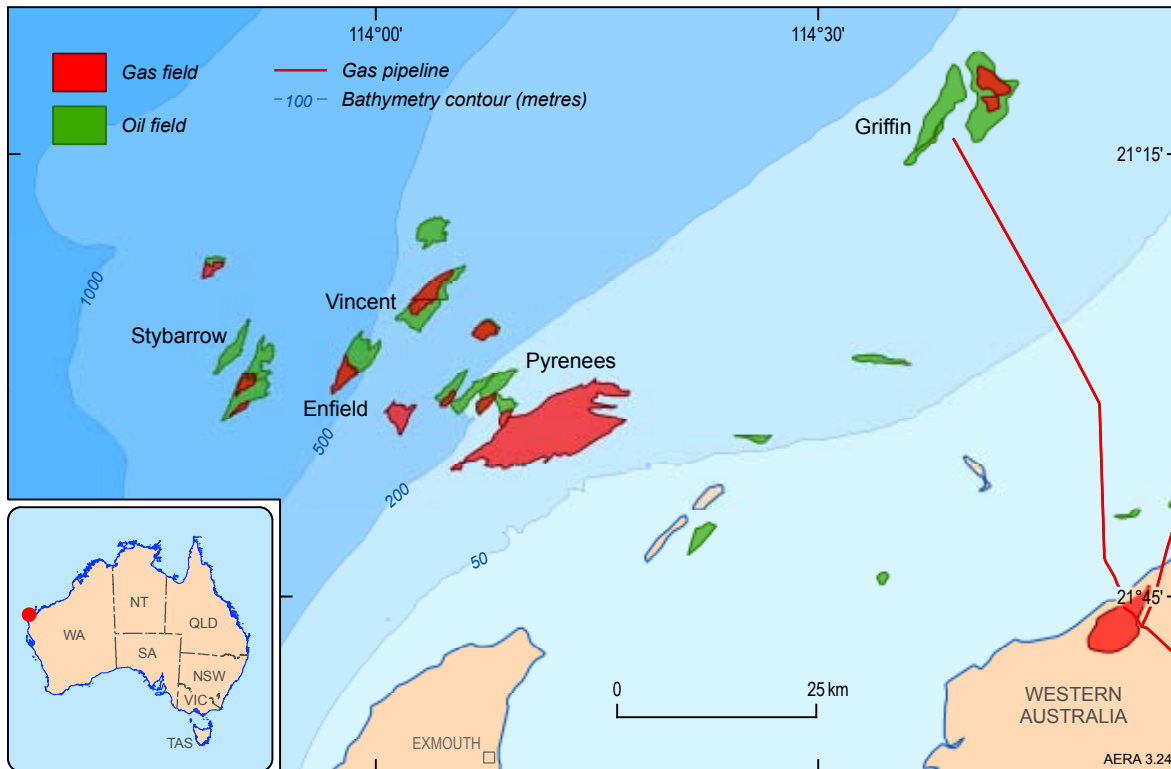
Source: ABARE; Geoscience Australia

unconventional oil resource, tar sands in the onshore Gippsland Basin, was exploited during World War II and in the post-war period (Bradshaw et al. 1999).

The high quality oil shale deposits in the Narrows Basin, near Gladstone, have been the subject of pre-

development studies for several decades (McFarland 2001). The Stuart Oil Shale Project achieved production from a demonstration-scale processing plant in the period 1999 to 2004, producing more than 1.5 million barrels of oil using a horizontal rotary kiln retort (box 3.2).



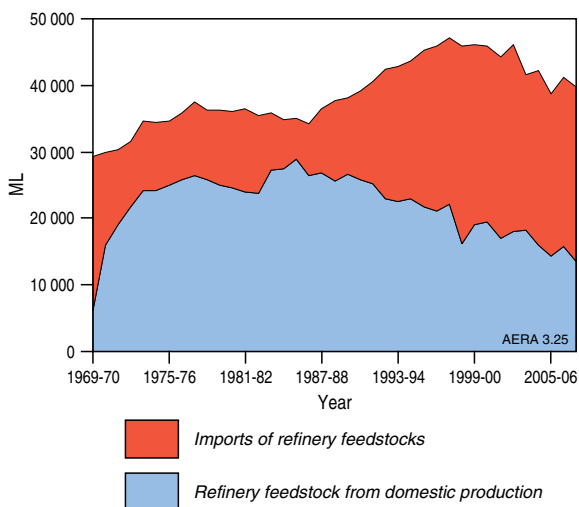


**Figure 3.24** Oil and gas fields and bathymetry, Exmouth Sub-basin, Carnarvon Basin

**Source:** Geoscience Australia

### Petroleum refining

The petroleum refining industry in Australia produces a wide range of oil products, such as gasoline, diesel, aviation fuel and LPG, from crude oil and condensate feedstock. In 2007–08, Australian refineries consumed 1333 PJ (226.7 mmbbl, 36 043 ML) of crude oil and condensate, of which imports accounted for around 68 per cent (figure 3.25). Most of the imports are used in the domestic petroleum refining industry in Eastern Australia, to offset the declining production from the Gippsland Basin.



**Figure 3.25** Sources of Australian refinery inputs

**Source:** ABARE 2009b

There are seven major petroleum refineries currently operating in Australia, managed by four companies — BP, Caltex, Mobil and Shell (table 3.11). These seven refineries have a combined capacity of around 42.7 billion litres a year. The largest of these are BP's Kwinana refinery in Western Australia and Caltex's Kurnell refinery in New South Wales. A refinery at Port Stanvac in South Australia ceased production in

**Table 3.11** Australian refinery capacity

	Operator	Year commissioned	Capacity MLpa
<b>New South Wales</b>			
Clyde	Shell	1928	4930
Kurnell	Caltex	1956	7320
<b>Queensland</b>			
Bulwer Island	BP	1965	5110
Lytton	Caltex	1965	6270
<b>South Australia</b>			
Port Stanvac <sup>a</sup>	Mobil	1963	(4520)
<b>Victoria</b>			
Altona	Mobil	1949	4530
Geelong	Shell	1954	6380
<b>Western Australia</b>			
Kwinana	BP	1955	7960
<b>Total<sup>b</sup></b>			<b>42 500</b>

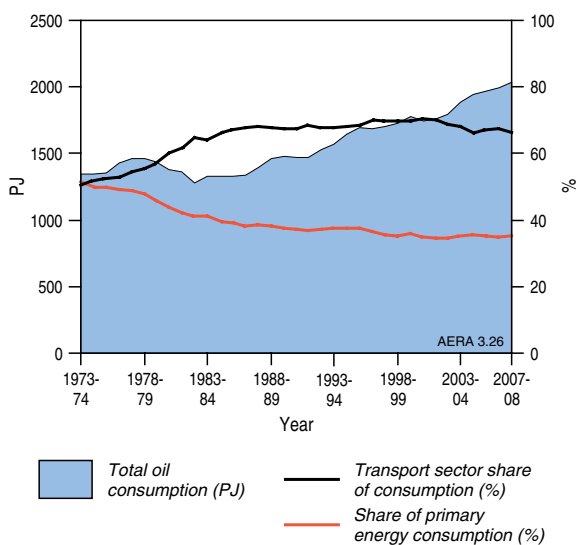
**Notes:** a The Port Stanvac refinery ceased production in July 2003; b Total of currently operating refineries; MLpa million litres per annum  
**Source:** Australian Institute of Petroleum 2007

2003 and is currently under a care and maintenance regime. Its closure is one of the reasons behind a decline in total refinery output, which has led to increased imports of refined petroleum products.

**Consumption**

Oil is second only to coal, in terms of shares in Australian primary energy consumption. However, its share has been declining steadily, from a high of almost 50 per cent of primary energy use in the late 1970s to around 34 per cent in 2007–08. Prior to 1979, Australia’s primary oil consumption had grown strongly at a rate of around 5 per cent per year. However, since then, consumption has been growing at a moderate rate of around 1 per cent per year to reach 1942 PJ (347 mmbbls, 55 168 ML) in 2007–08 (ABARE 2009b).

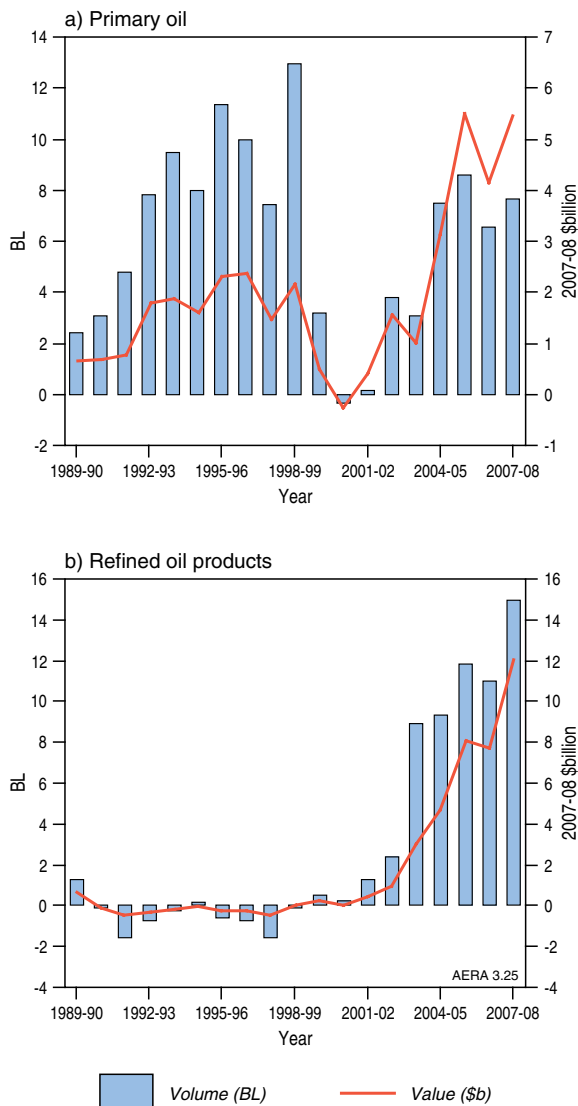
The transport sector is the largest consumer of oil products in Australia, currently accounting for around 70 per cent of total use, compared with 50 per cent in the 1970s (figure 3.26). The increased share has offset the decline in the industrial sector’s share, down from about 40 per cent in the 1970s to about 20 per cent in 2007–08.



**Figure 3.26** Australian oil consumption, share of total energy consumption and transport sector consumption  
**Source:** ABARE 2009b

**Trade**

Australia is a net importer of crude oil and oil products but a net exporter of LPG. More than 60 per cent of domestic crude oil and condensate production (18.6 billion litres, 688 PJ, 117 mmbbl) was exported in 2007–08, predominantly from the Carnarvon Basin in Western Australia to Asian refineries. This reflects their relative proximity to the major producing fields compared with the refineries on Australia’s east coast. Australia also imported 26 billion litres (962 PJ, 163.5 mmbbl) of combined crude oil and condensate to meet its domestic refineries’



**Figure 3.27** Australia’s net oil imports – volume and value

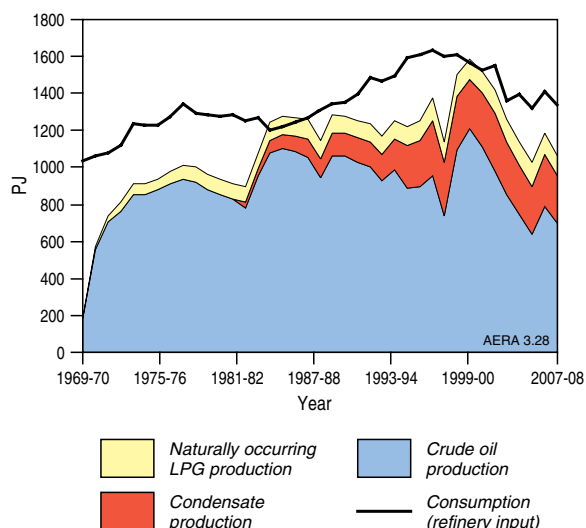
**Source:** ABARE 2008 and 2009c

requirements. In 2007–08, Australia’s net imports of primary oil (crude oil, condensate and LPG) were around 7.7 billion litres (383 PJ, 48.4 mmbbl), valued at \$5.5 billion.

For most of the 1990s Australia was a net exporter of refined oil products. Strong growth in consumption resulted in net imports from around 1999–2000 (figure 3.27). However, imports increased significantly following the closure of the Port Stanvac refinery in 2003 and amounted to around 15 billion litres (555 PJ, 94 mmbbl) in 2007–08. These imports were valued at around \$12 billion.

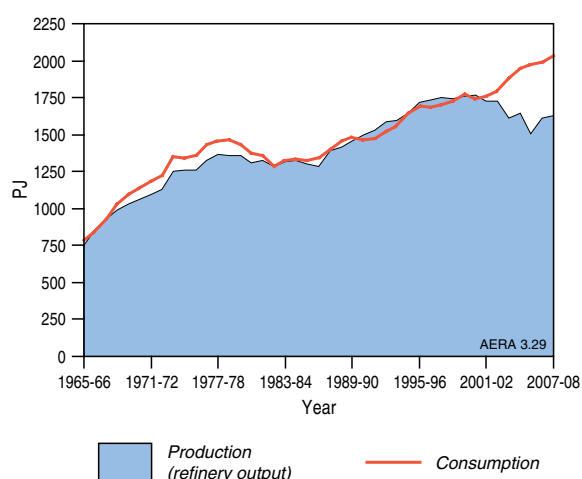
**Oil supply–demand balance**

Figure 3.28 provides a supply–demand balance for primary oil – production from oil fields and consumption in domestic refineries (refinery feedstock). Except for a brief period in the mid-



**Figure 3.28** Australian primary oil supply–demand balance

Source: ABARE 2009b



**Figure 3.29** Australian refined oil products supply–demand balance

Source: ABARE 2009b

1980s, Australia has relied on net imports to meet domestic refineries' needs. In 2007–08, refineries in Australia used 1462 PJ of feedstock with around 25 per cent of this input met from imports.

Figure 3.29 provides a supply–demand balance for refined oil products, that is, oil products produced from domestic refineries to meet domestic demand for liquid fuels. In contrast to primary oil, Australia was generally self sufficient in terms of refined oil products for substantial periods during the 1980s and 1990s, because Australia had enough refinery capacity to meet domestic demand for oil products. Since the closure of the Port Stanvac refinery in 2002–03, however, net imports of oil products have risen steadily, and in 2007–08 net imports accounted for around 30 per cent of total consumption.

## 3.4 Outlook to 2030 for Australia's resources and market

### 3.4.1 Key factors influencing the outlook

For the purposes of this assessment, a key assumption is that demand for oil will continue to grow and will be met from a variety of sources including imports, domestic conventional crude oil and condensate production, and unconventional sources. Given the rapid changes in the past decade where Australia moved from net exporter to importer of oil, further significant change is expected in the outlook period to 2030. There will be continued production from known fields, and the dominance of the basins offshore north-western Australia will be entrenched as production comes on stream from condensate-rich gas fields such as Ichthys in the Browse Basin, and as the newly developed Exmouth Sub-basin of the Carnarvon Basin reaches peak production. The major uncertainties in indigenous oil supply are whether exploration efforts in frontier basins will be successful in finding a new oil province; whether discovered resources are commercialised; and the role of unconventional oil sources (gas-to-liquids, coal-to-liquids, enhanced oil recovery and shale oil) as well as alternative transport fuels such as biofuels.

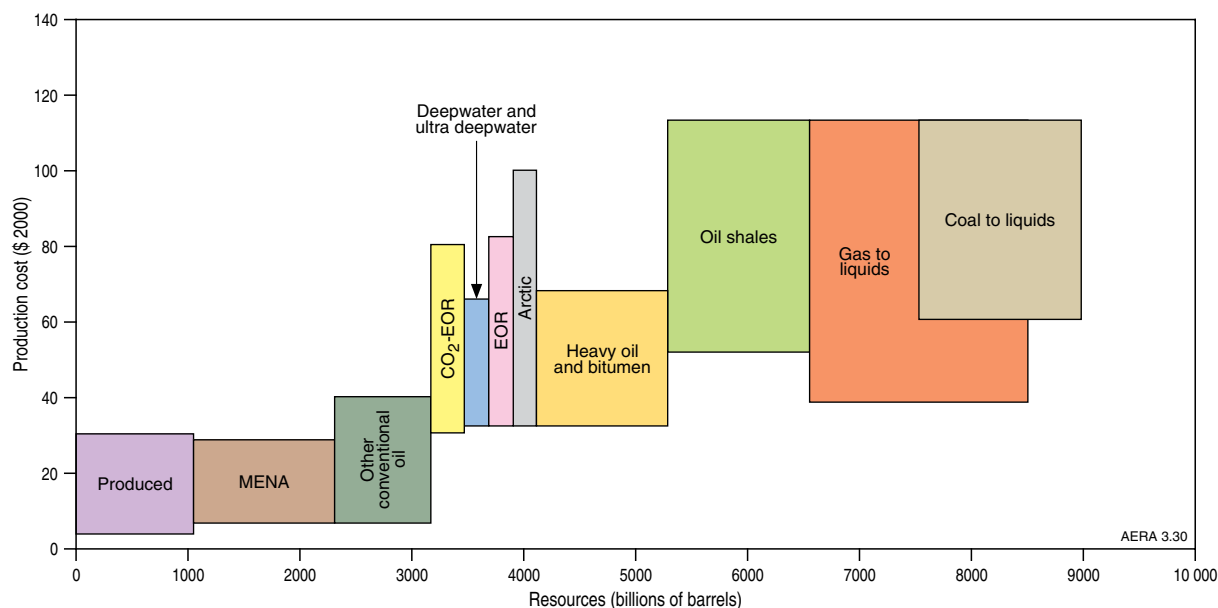
This outlook is affected by various factors, including the geological characteristics of the resource (such as location, depth, quality), economic characteristics of the resource (such as cost), developments in technology, infrastructure issues, fiscal and regulatory regime, and environmental considerations. The market price of oil is perhaps the most important factor of all in determining the incentives for oil exploration and development, especially for unconventional oil resources.

### Oil prices

Australia is a producer, exporter and importer of crude oil and refined products. Since deregulation of the oil sector in the late 1980s, Australia's oil market has been open, competitive and fully exposed to global market conditions.

Global oil prices are subject to both short-term price movements and longer-term price trends. Short-term oil price movements relate to influences on demand and supply of oil in the marketplace. These include cyclical/seasonal oil demand, the impact of supply disruptions such as hurricanes, accidents or sabotage, risk premiums associated with geopolitical tensions, and extraneous shocks to the economy such as the global financial crisis. In domestic market terms, significant exchange rate variations and market speculation can also affect short-term oil price movements.

In the longer term, an important driver of oil prices will be the underlying marginal cost of oil production,



**Figure 3.30** Long term oil supply cost curve

**Note:** MENA – Middle East and North Africa

**Source:** IEA 2008

which will have implications for oil supply, and a combination of long term economic growth and demand side efficiency improvements, which will have implications for oil demand.

The IEA's representation of the availability of oil resources and associated production costs is shown in figure 3.30. It shows that just over 1 trillion barrels of oil have already been produced at a cost of below US\$30 per barrel. There are potentially around 2 trillion barrels of oil remaining that can be produced at a cost below US\$40 per barrel, around three-quarters of them in OPEC member countries in the Middle East and North Africa (MENA). Reflecting its large, low cost reserves, OPEC's share of production is projected to increase from 44 per cent in 2008 to 52 per cent by 2030 (IEA 2009c). OPEC's decisions on oil field development will become progressively more important for the world oil market.

The importance of OPEC's investment decisions will be underpinned by the increasing cost of non-OPEC production. The majority of new non-OPEC investment is likely to be in offshore oil fields, increasingly in deeper water, further below the seabed and a greater distance from shore (including fields within the Arctic circle). The cost of oil production from deepwater sources and those needing advanced techniques such as EOR is estimated to be between US\$35 and US\$80 a barrel, similar to the cost of production from oil sands. The cost of producing oil from the Arctic could reach US\$100 a barrel because the large cost associated with developing infrastructure in an environmentally challenging area (IEA 2008).

The increase in oil prices over the past five years has encouraged exploration activity in frontier regions

such as the Campos Basin off the coast of Brazil and in deeper water in the Gulf of Mexico. The Brazilian Tupi field, for example, one of the most significant oil discoveries in the past 20 years, is 5 km below the surface of the Atlantic Ocean and below a salt layer up to 2 km thick. In September 2009, BP announced the discovery of the Tiber oil field in the Gulf of Mexico. The oil field is 10 700 m below the ocean floor and in water that is around 1200 m deep, making it one of the deepest drilled in the industry (BP 2009b). The continued development and application of deep water drilling and field development will eventually lead to lower production costs and the expansion of frontier areas where new oil fields can be developed in deeper water and further below the seabed, but the process at present is costly.

Synthetic oil production, such as shale oil, CTL and GTL, has the highest production costs, estimated by the IEA at up to US\$110 per barrel. This makes no allowance for any costs associated with the abatement of greenhouse gas emissions that are by-products of the process. At present there are very few commercial CTL and GTL projects, reflecting large capital and production costs and technically challenging production processes.

The future expansion of GTL capacity will depend on competing uses for gas such as for electricity generation, transport or export by pipeline or as LNG. One of the challenges for CTL is managing the high CO<sub>2</sub> output. Each barrel of oil produced from this technology releases between 0.5 and 0.7 tonnes of CO<sub>2</sub>, compared with around 0.2 tonnes of CO<sub>2</sub> from a barrel of oil from the GTL process (IEA 2008).

GTL plants are operating in Qatar, South Africa and Malaysia and there has been output from an experimental (500 bbls per day) plant in Japan. There is one CTL plant in South Africa.

In comparison to GTL and CTL, production from oil shale is the more uncertain, given its energy and carbon intensity. There is some oil production from oil shale in Brazil, China and Estonia. The introduction of a price for carbon would further increase the cost of shale oil extraction.

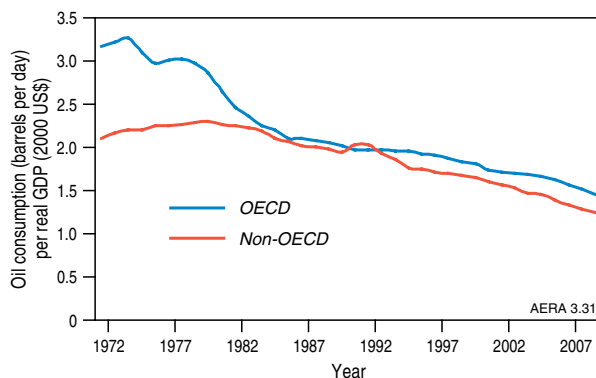
Recent high oil prices have encouraged investment in technology to improve extraction of oil from oil sands and research to commercialise oil production from coal and gas. If the R&D is successful, it should enable production of increased quantities of oil from unconventional sources. However, despite the recent R&D effort, production costs for these unconventional sources have all increased, associated with higher capital and operating costs.

Further information on the long term outlook for oil prices is contained in Chapter 2.

### Oil demand

The two factors expected to influence oil demand over the next two decades are the continued decrease in oil intensity in OECD economies and the increased oil consumption in non-OECD economies associated with strong economic growth.

In the OECD, oil intensity (the amount of oil consumed per unit of GDP) has been decreasing since the oil shocks of the 1970s (figure 3.31). One of the drivers of this trend has been the move away from oil-fired electricity generation capacity, to coal, gas or nuclear power. The increase in prices during 2007 and the first half of 2008 is likely to reinforce this trend and will encourage analogous responses in other areas of demand such as the transport sector. Improved fuel efficiency, increased uptake of alternative transport fuels and development of alternative transport modes are all possible impacts. The continued decrease in oil intensity also complements broader environmental and energy security policy goals.



**Figure 3.31** Oil intensity of GDP

Source: ABARE estimates from IEA 2009b data

Non-OECD economies, including China and India, are projected to grow strongly over the outlook period. Historically, there has been a strong correlation between economic growth and oil consumption, driven by higher personal incomes and increased demand for personal transport and vehicle ownership. The IEA projects that, by 2030, non-OECD economies will account for around 53 per cent of world oil consumption, compared with 41 per cent in 2008 (IEA 2009c).

### Resource characteristics

In Australia, the initial depositional environments and subsequent maturation history after burial that are required to produce and preserve crude oil accumulations (Box 3.1) have occurred less frequently than the geological conditions that have resulted in natural gas accumulations. Australia's identified conventional petroleum resources are dominated by widely distributed natural gas. In contrast, the major known accumulations of crude oil are restricted to the Gippsland Basin and five 'oily' sub-basins (Longley et al. 2002) along the north-west margin. This distribution is controlled by the occurrence of deep, narrow troughs containing mature oil source rocks which were formed around the continent's margins as it broke apart from Gondwana. The Gippsland Basin is a world class oil province with a number of giant fields: it is exceptional in the Australian context, having the greatest thickness of young (Cenozoic) sediments. Most of Australia's crude oil has come from this one small basin being sourced from an oil kitchen (the Central Deep) only about 50 km wide (figure 3.32).

Similarly, the crude oil in the Exmouth, Barrow and Dampier sub-basins of the Carnarvon Basin, and in the Vulcan Sub-basin and the Laminaria High – Flamingo Syncline of the Bonaparte Basin is derived from narrow Late Jurassic troughs filled with oil-prone source rocks. Some crude oil accumulations have been preserved in the older (Paleozoic) largely onshore basins but the major discovered resources and the greatest potential for future finds are offshore.

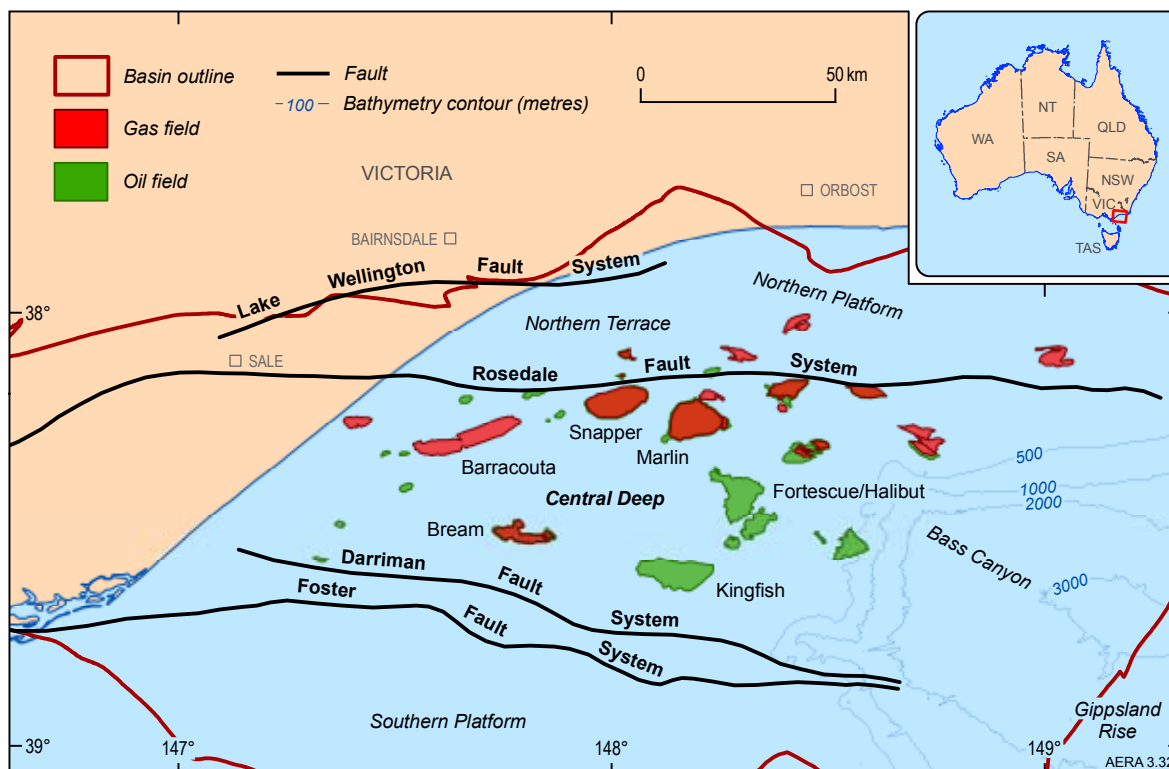
The condensate and LPG resources are also predominantly located in offshore basins, especially in giant gas fields on the North West Shelf. Gas liquids are not present in the large coal seam gas (CSG) resources identified in onshore eastern Australia.

Australian shale oil resources are variable in organic richness and moisture content. Those in Cenozoic basins of eastern Queensland are thick and relatively shallow deposits with viable oil yields, and have a low carbonate content which does have advantages in processing, including less CO<sub>2</sub> release.

### Technology developments

The development of conventional oil resources in the past has benefited from significant technological





**Figure 3.32** Gippsland Basin showing oil and gas fields and structural elements

**Source:** Geoscience Australia, from data provided by GeoScience Victoria

change over a sustained period of time, leading to increased access to reservoirs, increased recovery of reserves, reduced costs of exploration and production, and reduced technical and economic risks to the development of oil projects. There are similar technological advances – and needs – in developing unconventional resources. Both are discussed in more detail below.

#### *Development of exploration technology*

Exploration involves a number of geophysical and drilling activities to determine the location, size, type (oil or gas) and quality of a petroleum resource. Prior to area selection, initial regional studies (figure 3.33) may use non-seismic survey techniques (gravity, magnetic and geochemical surveys, satellite imagery and sea-bed sampling) to define sedimentary basins and to determine if there are any indications of natural hydrocarbons seepage. Recent technological developments, such as accurate global positioning systems, improved computing power, and algorithms for reprocessing existing seismic data and advanced visualisation techniques used to combine different data sets (Wilkinson 2006), have enhanced the value of this phase of the exploration process, especially in offshore frontier basins. In Australia, with its largely under-explored vast on- and offshore jurisdiction, government has taken an active role in providing this regional scale pre-competitive information to stimulate exploration.

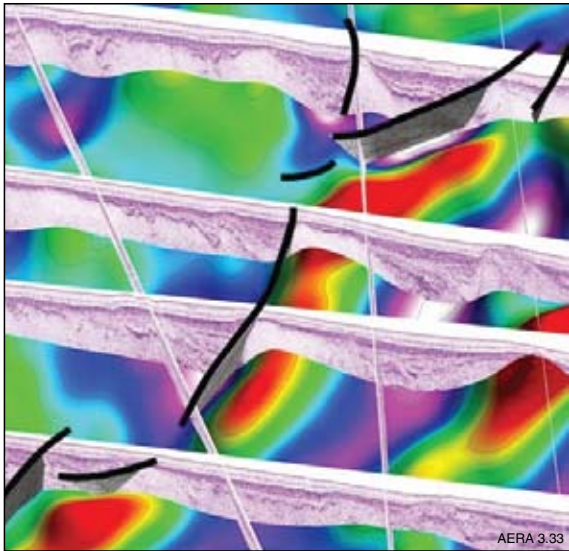
Hashimoto et al. (2008) demonstrate how a variety of geophysical and other datasets can be integrated to assess the structure and petroleum potential of the remote frontier Capel and Faust basins offshore from eastern Australia. Figure 3.33 is a 3D view across the undrilled Capel and Faust basins showing seismic lines integrated with gravity imagery. These datasets have assisted in the identification of potentially prospective thick sedimentary depocentres, bounding faults and structural highs underlain by shallow basement within this vast frontier area.

Once the prospective area is located, more detailed seismic survey techniques are used to determine subsurface geological structures. Advances in 3D seismic imaging can now display the subsurface structure in greater detail (Wilkinson 2006) and amplitude analysis can reveal potential petroleum-bearing reservoirs, contributing to recent high drilling success rates in the Carnarvon Basin (Williamson and Kroh 2007). Developments in exploration drilling now allow prospective structures identified on seismic to be tested in water depths beyond two and half kilometres.

#### *Development of production technology*

For onshore fields, development proceeds in step with the appraisal drilling. In offshore fields, however, the optimal number and location of development wells must be identified prior to proceeding with the development.





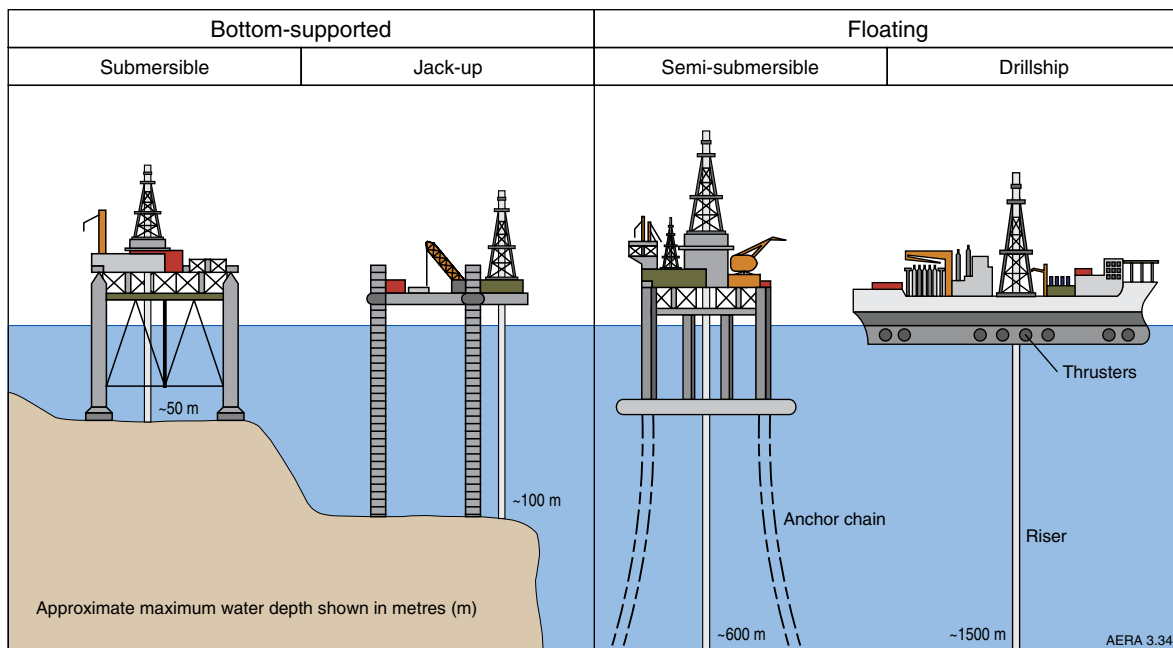
— Fault

**Figure 3.33** Integrated seismic and gravity data showing the location of major faults, sedimentary depocentres (gravity lows denoted in blue tones) and areas of shallow basement (gravity highs denoted in red tones) from the remote Capel and Faust basins

**Source:** Geoscience Australia

Oil production requires the establishment of production wells and facilities. At the initial stage of production, the natural pressure of the sub-surface oil reservoir forces oil to flow to the wellhead. This primary recovery commonly accounts for 25 to 30 per cent of total oil in the reservoir (CEM 2004), though some offshore Australian reservoirs have recovery rates of 70 or 80 per cent supported by a natural strong water drive, as in the case of the Gippsland Basin. More commonly, advanced recovery techniques are employed to extract additional oil from the reservoir, including injecting water or gas into the reservoir to maintain the reservoir's pressure. Pumps can also be used to extract oil. These conventional techniques can increase the additional amount of recoverable oil by around 15 per cent.

Enhanced oil recovery (EOR) is a more advanced technique that has been developed to extract additional oil from the reservoir. This technique alters the oil properties, making it flow more easily, by injecting various fluids and gases, such as complex polymers, CO<sub>2</sub> and nitrogen, to enable more oil to be produced. This technique could increase oil recovery by an additional 40 per cent, but is costly to implement (IEA 2007). Currently, there are 11 countries, including Australia, participating in the IEA's EOR Implementing Agreement, which encourages international collaboration on the development of new oil recovery technologies, including less costly EOR technology. While these techniques have been employed in the past, currently there is no EOR in Australia.



**Figure 3.34** Types of offshore drilling vessels

**Source:** Wilkinson 2006

Reflecting the large number of oil resources located offshore, most R&D has been directed toward offshore technologies. There are several possible development options for offshore oil projects, based on bottom-supported and floating production facilities. The development of these options is dependent on several factors including resource type, reservoir size, water depth and distance from shore. Bottom-supported platform developments are suitable for relatively shallow water depth (figure 3.34).

Access to deep water fields has become technologically feasible with the recent development of floating facilities and tension leg platforms (Wilkinson 2006). The maximum water depth at which oil projects can be developed increased from 6 m in 1947 to 312 m in 1978 and 1027 m in 1995 (Hogan et al. 1996). More recently, maximum water depths for petroleum production have increased further to beyond 2300 m with the Cheyenne field (Anadarko 2007) and the Perdido development (Shell 2009) in the United States' Gulf of Mexico.

There have also been technological developments in shale oil production particularly in the United States where several companies are testing in situ technologies to extract shale oil at more than 300m depth (USDOE 2007). In comparison Australia's oil shales are relatively shallow deposits and the focus has been on surface extraction technologies (Geoscience Australia 2009b).

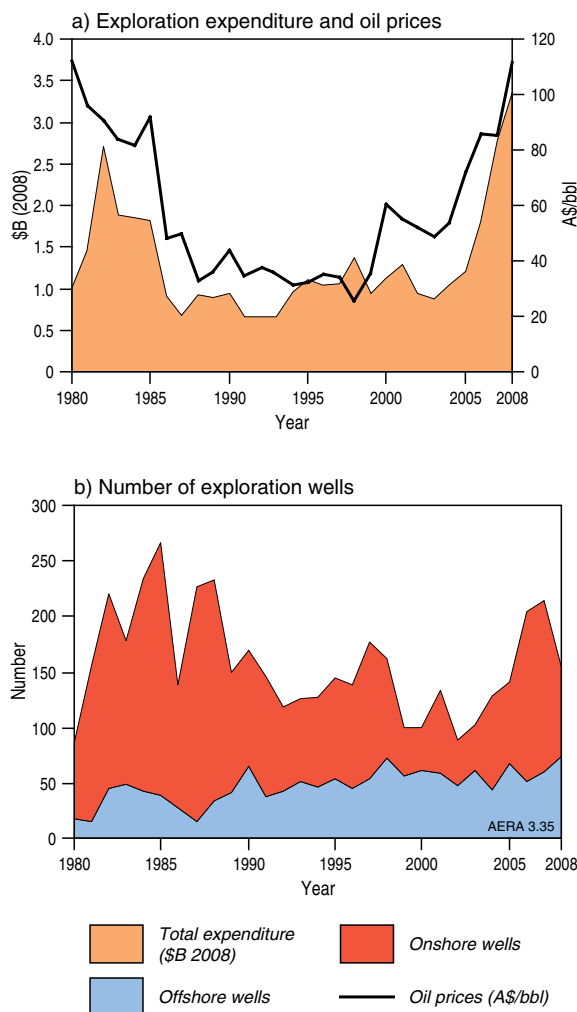
### Oil supply economics

The process of supplying oil is complex, involving steps such as exploration, development, production, processing/refining and transport (section 3.3.2). Upstream oil costs (exploration, project development and production) are a major component of total costs within the oil and refined products industry.

Over the past five years, there has been a considerable increase in exploration, project development and production costs. This increase in costs largely relates to increased competition for inputs (drilling rigs, production equipment, labour) as oil fields were developed in response to higher prices. In Australia, costs have increased as a result of global demand for inputs, but also because of the nature of resources. Australia's remaining undeveloped oil resources are generally located in fields that are further offshore, in deeper water and further below the ocean floor. These factors increase the technical and economic challenges associated with exploration, development and production of Australia's oil resources.

### Exploration

Oil exploration is fundamentally concerned with the management of risks (Jones 1988). The expected location, size and quality of oil reservoirs are crucial in decision making because large oil deposits



**Figure 3.35** Exploration for Australia's petroleum resources

**Source:** Geoscience Australia, Australian Bureau of Statistics 2009

generally mean large payoffs. When an exploration well is drilled, there is a risk that no oil will be found and therefore no revenue generated. Even if oil is found, there is still a risk that it will not be available in commercially exploitable quantities or that the costs of development and production are sufficiently high to render the new discoveries non-viable. Because of this risk, a large exploration expenditure is generally required, and only a small portion of this expenditure will actually lead to the discovery of resources that are economically viable to extract.

Figure 3.35 provides key indicators of exploration expenditure and activity, in terms of the number of exploration wells drilled, for Australia's petroleum resources, both oil and gas. Between 2002 and 2007 there was a significant increase in the number of exploration wells drilled. Higher oil prices encouraged companies to explore because of the increased potential returns associated with a discovery. In 2008, the number of exploration wells

decreased significantly even though the level of exploration expenditure continued to rise. The number of onshore exploration wells drilled declined steeply from more than 150 in 2006 and 2007 to 80 wells in 2008 whereas the number of offshore exploration wells increased slightly, reaching an all time high of 74 wells in 2008. The cost associated with drilling each well increased dramatically in the first half of 2008 associated with a worldwide shortage of drilling equipment and labour. The oil price fell dramatically in the second half of 2008 but recovered in 2009 to levels well below the highs reached the previous year (Chapter 2). The fall in oil price may have discouraged discretionary onshore exploration as some companies sought to reduce expenditure as global capital markets dried up. Oil price fluctuations tend to have a less immediate impact on offshore exploration. Permit drilling commitments and rig contracts delay response to oil price signals and many offshore exploration wells target gas rather than oil.

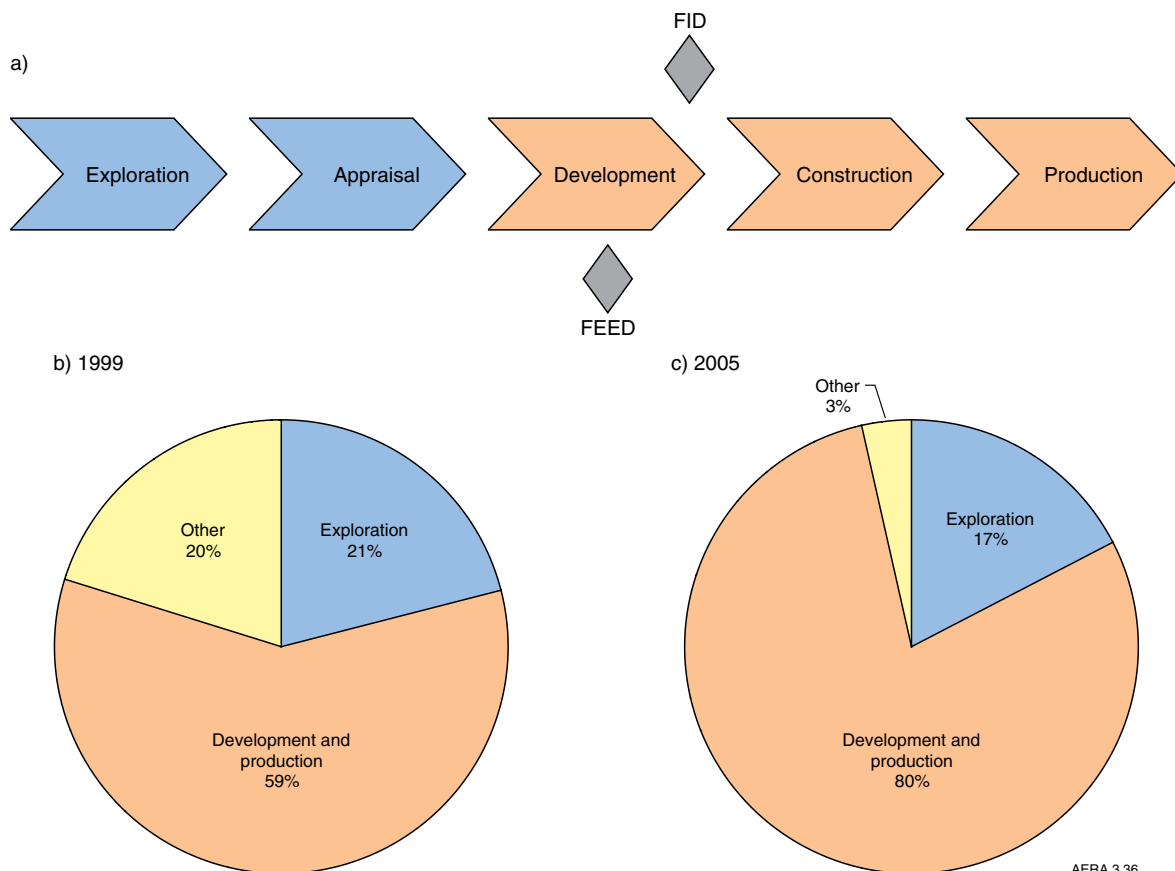
Since 1980, more exploration wells have been drilled onshore in Australia than offshore. This reflects the relatively lower cost of onshore oil exploration. In 2005, the average cost of surveying and drilling an onshore exploration well in Australia was around

A\$3 million, while that for offshore was around A\$12 million (ABARE and Geoscience Australia). Hence, smaller companies are generally involved in onshore exploration, while offshore exploration is mostly undertaken by larger companies.

Since 2005 exploration expenditure has exceeded a billion dollars annually and steeply risen to an expenditure totalling \$3.36 billion in 2008 (Australian Bureau of Statistics 2009), mirroring the rise in oil prices and exceeding the previous peak in exploration in the early 1980s. However, in an environment of increased drilling costs this large rise in exploration investment has not translated into more wells drilled.

### Development

Figure 3.36 shows the flow of activities from exploration to production of an oil field. During exploration and appraisal, the oil field is discovered and the reserves estimated for potential development. The development of an oil field includes the planning and construction processes. Planning involves a preliminary design (or feasibility study) followed by a front-end engineering and design (FEED) study. The FEED provides definitive costs and technical details to enable a final investment decision (FID). After a FID has been made, construction



**Figure 3.36** Components of upstream petroleum expenditure, a) steps in development process, b) expenditure by activity in 1999, c) expenditure by activity in 2005

**Note:** FEED – front-end engineering and design, FID – final investment decision

**Source:** Geoscience Australia 2008

can commence. The average time from discovery to production for Australian new field crude oil discoveries is about five years (Powell 2004).

The development and production of oil is technically complex which results in large capital expenditure. In Australia, the majority of oil production occurs below the seabed, often in water that is hundreds of metres deep. This requires specialised equipment that can withstand the pressure and temperatures of deep water and deep within the sedimentary section.

Project development costs have increased significantly over the past six years, both in Australia (figure 3.37) and globally. This increase in expenditure is twofold. Firstly, the increase in oil prices has encouraged the development of new capacity which has placed upward pressure on prices for inputs such as labour and equipment globally. Secondly, newly developed oil fields in Australia tend to be in deeper water and further offshore (table 3.12), which increases the technical complexity of the project and hence cost. Extensions to existing

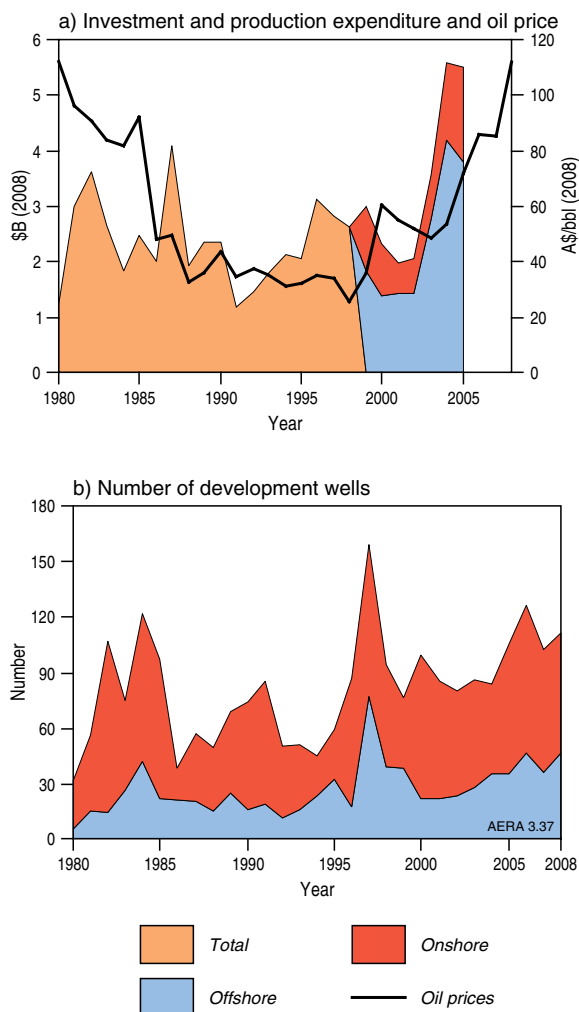
projects, such as Laminaria Phase 2 (table 3.12), can achieve additions to capacity at lower cost than entire new developments.

**Production**

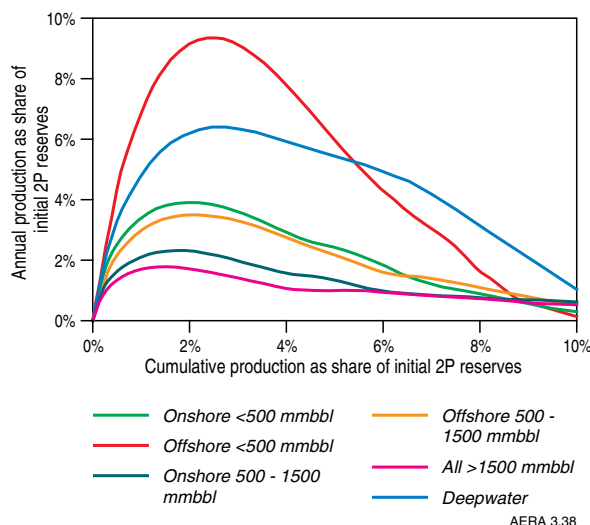
Each oil field has a unique production profile, depending on the natural characteristics of the reservoirs including locations, depth and size of the reservoirs and the nature of production from an oilfield including commercial and policy decisions. However, a typical production profile of an oilfield looks similar to a bell-shaped curve that skews to the left and can be divided into three phases. These include a build-up phase where production rises as new wells are developed, a plateau phase where production from new wells offsets a natural decline from old wells, and a decline phase where the resource from an oilfield begins to deplete.

A typical oil production profile for various types of oilfields is shown in figure 3.38, by plotting annual and cumulative production from the sample of oilfields with respect to their reserves. In general, the build-up to peak production is longer for a larger oilfield, whereas smaller fields reach their peak sooner and decline more rapidly than large fields. Figure 3.38 shows that, for an average onshore oilfield, around 20 per cent of reserves from a small field are produced during the build-up phase, compared with just over 10 per cent for a larger field.

For some large fields, such as the Zakum field in the United Arab Emirates where production started in the late 1960s, the build-up period took more than several decades before it reached peak production in 2002. In contrast, the smaller Hassi Berkine Sud field in Algeria where production started in 1998 has already passed its peak production (IEA 2008).



**Figure 3.37** Development and production of Australia's petroleum resources  
**Source:** Geoscience Australia



**Figure 3.38** Typical oil production profiles  
**Source:** IEA 2008

**Table 3.12** Australian oil projects, capital costs, unit costs

Project	State	Year completed	Capital cost A\$m	Additional capacity (kbpd)	A\$/bpd	Water depth (m)
Roller/Skate	WA	1994	170	-	-	10
Elang/Kakatua	WA	1998	42	40	1050	-
Stag	WA	1998	180	50	3600	49
Cossack/Wanaea	WA	1999	190	25	7600	80
Laminaria/Corallina	WA	1999	1370	155	8839	-
Buffalo	WA	2000	145	40	3625	-
Lambert/Hermes	WA	2000	120	16	7500	126
Legendre	WA	2001	110	40	2750	52
Laminaria Phase 2	WA	2002	130	65	2000	-
Mutineer-Exeter	WA	2005	440	90	4889	168
Basker and Manta	Vic	2005	260	20	13 000	-
Enfield	WA	2006	1480	74	20 000	544
Cliff Head	WA	2006	285	12.5	22 800	-
Puffin	NT	2007	100	25	4000	-
Vincent (stage 1)	WA	2008	1000	100	10 000	-
Stybarrow	WA	2008	874	80	10 925	800
Woollybutt	WA	2008	143	7	20 429	100

**Note:** kbpd – thousands of barrels per day, \$A/bpd – cost in Australian dollars per additional barrel per day production capacity

**Source:** ABARE

In addition, oilfields that are located offshore generally reach peak production in a shorter time than reserves that are located onshore. For oilfields that contain reserves of less than 500 mmbbl, around 25 per cent of reserves from an offshore oil field are produced by the time production reaches its peak (figure 3.38). This compares with cumulative production of around 20 per cent for fields of the same size that are located onshore. The production profile of offshore fields reflect their higher development costs relative to onshore fields, which generally trigger the project developer to recover oil more quickly in order to keep the cashflows for further development. Deeper offshore oil fields tend to reach peak production early.

In Australia, total conventional oil production (including crude oil, condensate and LPG) is increasingly from offshore oilfields with deeper oil accumulations (table 3.12) and fields that contain smaller reserves compared with those developed in the past. Given the typical production profile of these types of reserves, increased exploration activity is required and more oil wells need to be drilled if the current production level is to be maintained.

### Infrastructure issues

Australian oil infrastructure is generally well developed, from upstream oil developments to processing at refineries. There have not been any recent significant increases in Australia's oil refinery capacity, however substantial capital is spent on existing refineries to ensure continued and reliable

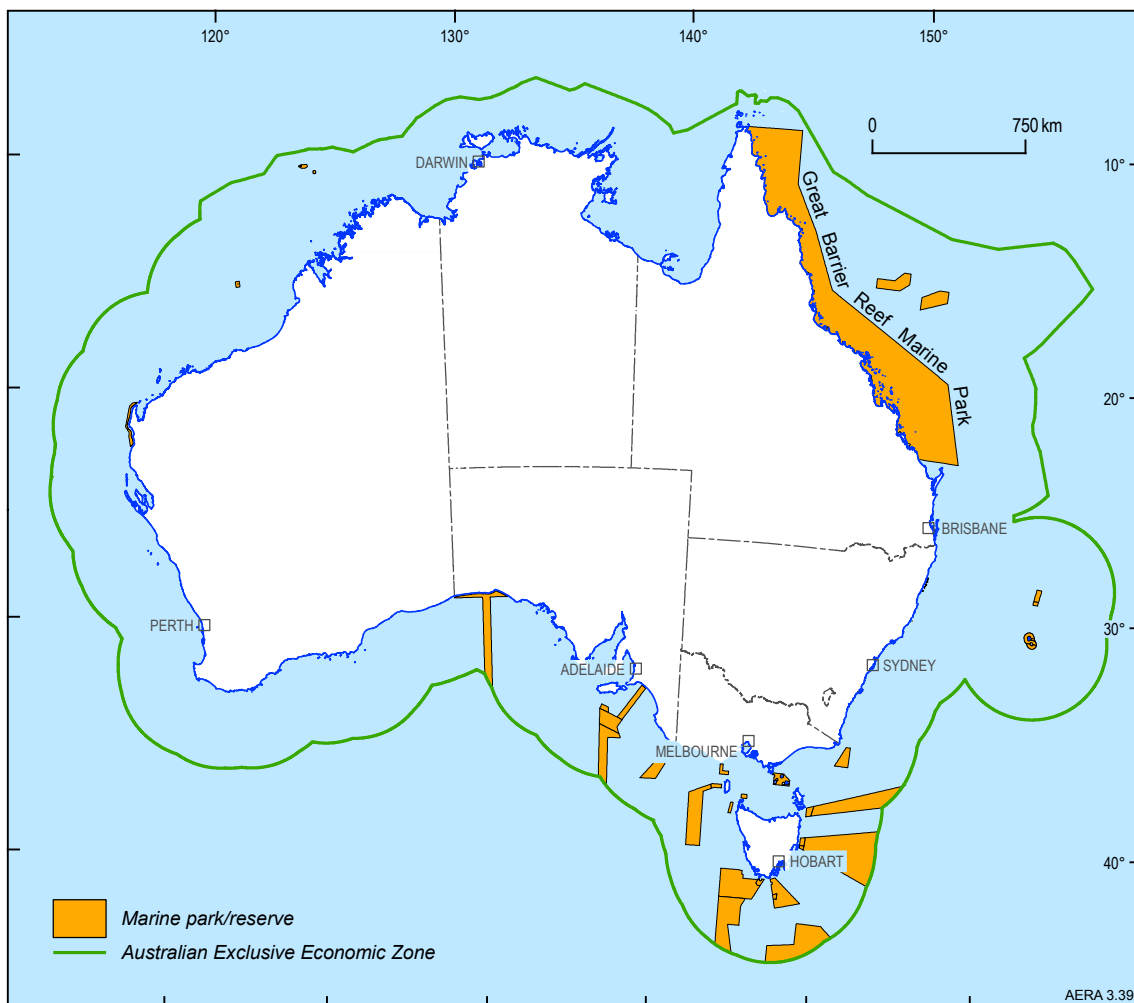
production of clean fuels. Australia's liquid fuel supply has also been enhanced by imports from refineries in the Asia Pacific region. The increased interdependency between refineries (with the move to cleaner fuels), and little spare refining capacity has the potential for a refinery disruption to impact on supply (ACILTasman 2008).

Given the likely increased levels of imports of refined product, investment in import/export infrastructure, including the possibility of greater storage capacity to mitigate supply disruption will be of growing importance. Resolution of policy issues impacting on markets, including national and international decisions on emission reductions targets, and methods to achieve them, such as levels of support for alternative transport fuels, will help enhance investment decision-making.

### Environmental considerations

The Australian State/Territory governments require petroleum companies to conduct their activities in a manner that meets a high standard of environmental protection. This applies to the exploration, development, production, transport and use of Australia's oil and other hydrocarbon resources. Onshore and within three nautical miles of the coastline the relevant state/ territory government has the main environmental management authority although the Australian Government has some responsibilities regarding environmental protection, especially under the *Environmental Protection and Biodiversity Conservation (EPBC) Act 1999*.





**Figure 3.39** Current marine protected areas of Australia

Source: DEWHA 2008

In the offshore areas beyond coastal waters the Australian Government has jurisdiction for the regulation of petroleum activities. The objective-based Petroleum (Submerged Lands) (Management Environment) Regulations 1999 provide companies with the flexibility to meet environmental protection requirements. Petroleum exploration and development is prohibited in some marine protected areas offshore (such as the Great Barrier Reef Marine Park) and tightly controlled in others where multiple marine uses have been sanctioned (figure 3.39). Environmental Impact Assessments (EIA) required as pre-conditions to infrastructure development applications – especially of larger projects – may require environmental monitoring over a period of time as a condition to the approval before the development can commence. In some cases regional-scale pre-competitive baseline environmental information is available from government in the form of regional syntheses containing contextual information that already characterises the environmental conditions in the area of the proposed

development. In the offshore area typical data sets that are required for marine EIA in EPBC Act referrals include: bathymetry, substrate type, seabed stability, ocean currents and processes, benthic habitats and biodiversity patterns.

Oil spills are a potential environmental risk that requires careful management during exploration and production phases. Safeguards are in place through the Australian Marine Safety Authority (AMSA 2009). There are also well established processes for mitigating other environmental concerns including the impact of seismic surveying on cetaceans.

The mining, processing and refining of shale oil involves a somewhat different range of environmental issues, including disposal of spent shale, impacts on air and water quality, and greenhouse gas emissions. Heating oil shale, whether above or below ground, requires energy inputs and entails emissions. The composition of Australian oil shales is low in carbonates, making carbonate decomposition to CO<sub>2</sub> less of a problem in Australia than it is in some other deposits.



### 3.4.2 Outlook for oil resources

For **conventional liquid petroleum** resources additions will come from several potential sources:

- Field growth – extensions to identified fields and revisions to recovery factor estimates;
- Enhanced oil recovery (EOR) from existing fields;
- Discovery of new commercial fields in established hydrocarbon basins; and
- Discovery of new fields in frontier basins that become commercial by 2030.

#### Field growth

Growth in reserves in existing fields can add significantly to total reserves, for example by 40 per cent for sandstone reservoirs in the North Sea (Klett and Gautier 2003). These increases are based on new information gathered about the extent and nature of the initial oil pool intersected by the discovery well during the development and production phases. Factors which can contribute to field growth were listed by Powell (2004) as including:

- Increases in the known volume of discovered pools from drilling and geophysical data;
- New pool discoveries often by development wells;
- Improved development technology allowing a greater proportion of the oil-in-place to be produced; and
- Revised assessment of reservoir and fluid properties leading to higher recovery factors than those originally calculated, with real world reservoir performance data substituting for initial generic assumptions.

Geoscience Australia estimated that there was scope for an additional 5880 PJ (1000 mmbbl) of liquid petroleum resource (crude oil and condensate) from field growth in identified fields. Some of this potential may have already been realised as these estimates were made several years ago (Geoscience Australia 2004, 2005).

#### Enhanced Oil Recovery

Geoscience Australia estimated in 2005 that there was scope for about an additional 6468 PJ (11.00 mmbbs) of crude oil from EOR. However, currently there is no EOR production in Australia, and none in offshore fields anywhere in the world.

Application of EOR depends on the availability (supply) and cost of miscible gases such as CO<sub>2</sub> or nitrogen (Wright et al. 1990), oil price, technology advances and the geology of the reservoir. Because of initial recoveries of up to 60 per cent or more of the oil in place, it is considered unlikely that EOR from Australia's major oil reserves in offshore basins will contribute significantly to liquid fuel supply in the outlook period. Field growth through improved reservoir performance also reduces the target

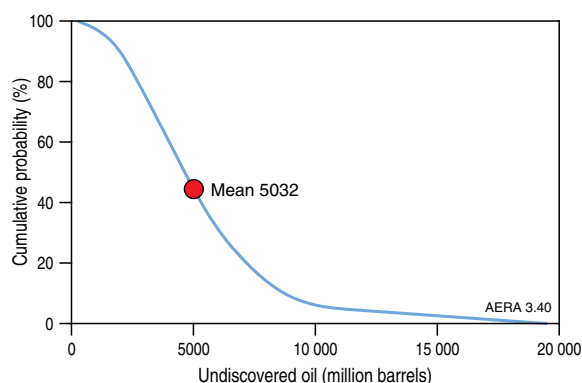
volume of oil in place for EOR. There may be some minor EOR production from onshore basins where enhanced recovery is coupled with CO<sub>2</sub> storage as in the proposed Moomba Carbon Storage project in the Cooper Basin (Santos 2009).

#### Discovery of new fields in established hydrocarbon basins

Successful exploration in hydrocarbon producing basins is a major potential contributor to Australia's conventional oil resources. The volume of new reserves added is dependent on the number of exploration wells drilled, the size of the prospects tested and the success rate for oil discoveries that can be commercially developed. Perceptions of prospectivity and the economic, regulatory and fiscal environment influence the number of exploration wells drilled (Bradshaw et al. 1999); while geological factors, as outlined in box 3.1, determine the field size distribution and the chance for oil. As a basin is explored the size of prospects tested generally decreases, as the largest structures are usually those first drilled. However, application of new geological concepts and new technology can reverse this trend.

The number of exploration wells drilled in Australia has varied through time but prior to the recent peak there has been a long term decline in onshore drilling (figure 3.35). The historical success rates are around 20 per cent for petroleum exploration in Australian basins, but lower when crude oil only is considered.

A number of assessments of the undiscovered oil potential of Australia's major hydrocarbon producing basins have been undertaken using different methods, including those used by the USGS and the more conservative approach employed by Geoscience Australia (box 3.3). As noted by Powell (2001), undiscovered resource assessments have multiple inbuilt uncertainties and only have validity in the context of the method used and the purpose for which they were undertaken. Estimates in established hydrocarbon basins can be based on the known discovery history trends and field



**Figure 3.40** Australia's undiscovered oil resources

**Source:** USGS 2000

## BOX 3.3 RESOURCE ASSESSMENT METHODOLOGIES

**USGS World Petroleum Assessment (USGS 2000)** – estimation of the long-term geological potential of the total petroleum system in a basin. It is limited to conventional potential resources that could be added to reserves in a 30 year time frame and based on the demonstrated existence of generative (mature) source rocks and geological models of petroleum occurrence. The geological opinion of a panel of experts is used to establish probabilities for the chance of occurrence, number and size of fields, and proportions of oil, gas and condensate. Probability distributions are then computed for undiscovered resources.

**Geoscience Australia assessments** – discovery

forecasts for a limited time horizon (typically 5 to 15 years) and an emphasis on discovery modelling using known exploration trends (Powell 2001). The assessment unit is a single migration fairway comprising a system of traps that is contained with a sequence of source, reservoir, and cap rocks and is separated from adjacent systems by geological barriers to tertiary migration of hydrocarbons. The approach uses log linear models of drilling or discovery to estimate the size of potential future discoveries, and takes into account existence risk, exploration success rate, the proportion of oil and gas, and the smallest size to be included as a resource (Powell 2001).

**Table 3.13** Estimates of undiscovered potential in Australian basins

Basin	Crude Oil						Condensate					
	95%		Mean		5%		95%		Mean		5%	
	PJ	mmbbl	PJ	mmbbl	PJ	mmbbl	PJ	mmbbl	PJ	mmbbl	PJ	mmbbl
Bonaparte	2252	383	7562	1286	15 317	2605	1564	266	6345	1079	14 124	2402
Browse	1347	229	6203	1055	15 323	2606	1241	211	5492	934	12 965	2205
Carnarvon	5069	862	14 000	2381	23 826	4052	7138	1214	21 650	3682	38 408	6532
Gippsland	606	103	1823	310	3428	583	423	72	1993	339	4398	748
<b>Total</b>	<b>9273</b>	<b>1577</b>	<b>29 588</b>	<b>5032</b>	<b>57 894</b>	<b>9846</b>	<b>10 366</b>	<b>1762</b>	<b>35 480</b>	<b>6035</b>	<b>69 896</b>	<b>11 887</b>

**Note:** 95%, Mean and 5% denote the probability of the resources exceeding the stated value

**Source:** USGS 2000

size distributions, and a substantial geological dataset which has sampled the natural variability in the basin. They are also dynamic and change as knowledge improves and uncertainties are resolved, assessments of frontier basins are more uncertain as there is no local history of exploration outcomes on which to base the estimates. The results of undiscovered resource assessments are best considered as probability distributions rather than as a raw number. Figure 3.40 is a cumulative probability plot of Australia's undiscovered oil resources in the major offshore producing basins as generated by the USGS (2000). Each point of the curve shows the probability of discovering at least the amount of oil shown on the horizontal axis.

Geoscience Australia estimates that risked mean undiscovered resources in currently producing basins are around 9996 PJ (1700 mmbbl) of crude oil and 4116 PJ (700 mmbbl) of condensate. The USGS assessment at the 50 per cent probability (P50) of 29 588 PJ (5032 mmbbl) of crude oil and 35 480 PJ (6035 mmbbl) of condensate (table 3.13) is substantially more optimistic than the conservative shorter-time horizon Geoscience Australia assessment. The USGS assessment represents an indicative estimate of the ultimate resource potential for these basins (Powell 2001) whereas the

Geoscience Australia estimate may better reflect the potential oil resources discovered in producing basins by 2030 given current exploration drilling rates. The Carnarvon Basin is considered the most prospective of the basins assessed to contain large undiscovered resources of crude oil and condensate (table 3.13).

The USGS assessment focussed only on the most prospective of Australia's established hydrocarbon basins and did not include the Cooper/Eromanga, Bowen/Surat, Perth, Otway and Bass basins, all of which have had oil discoveries in the past decade, although of only modest size (10 mmbbl, 59 PJ or considerably less).

There is still crude oil to be found in the established basins, especially in the less explored zones, such as the deep water extensions of the proven areas, but giant oil field discoveries are considered unlikely in the context of current play concepts and technology. The analysis of Powell (2004) showed that most established basins demonstrated 'a very strong creaming effect', implying that the large oil fields had already been found in these basins. The exceptions were the Carnarvon and the Perth basins. In the Carnarvon Basin the successful exploration of the deep water Exmouth Sub-basin has provided the largest additions to crude oil reserves (around 500

mmbbls, 2940 PJ), but in the Perth Basin the early promise of the offshore Cliff Head discovery has not been followed up with more substantial finds in the surrounding area. However, most of the deepwater offshore Perth Basin remains untested and it is the focus of new pre-competitive data acquisition by Geoscience Australia.

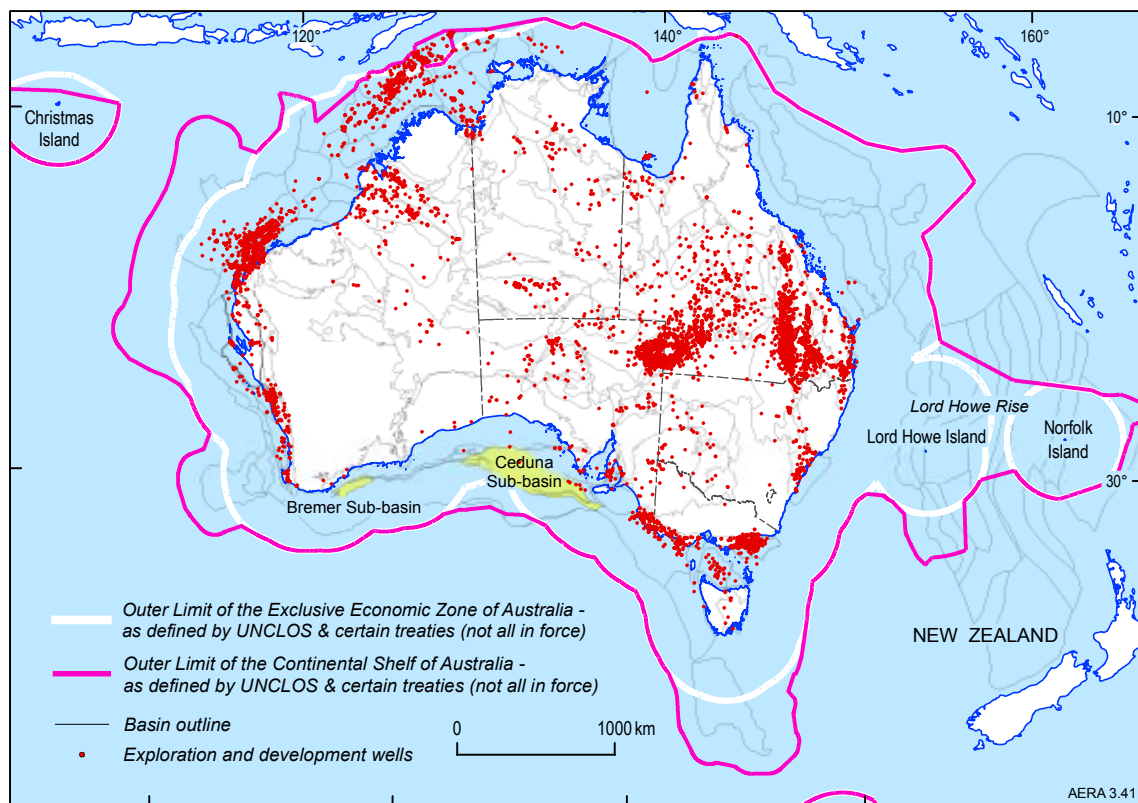
In comparison, the North West Shelf is more fully explored and Longley et al. (2002) reviewed the chances of finding a new oil province, similar in size and significance to the Exmouth Sub-basin, on the shelf and concluded that it was unlikely. Since this prediction a number of the less explored sub-basins have been drilled, including deepwater tests at Maginnis-1 in the Seringapatam Sub-basin, Browse Basin; Huntsman-1 in the Rowley Sub-basin, offshore Canning Basin; Wigmore-1 in the Beagle sub-basin and Herdsman-1 in the southern Exmouth Sub-basin, Carnarvon Basin (Walker 2007). However, none of these were successful in finding a new oil trend and the pattern of known oil occurrence on the North West Shelf remains confined within the proven parts of the Bonaparte, Browse and Carnarvon basins. Successful exploration has proceeded in these basins but with the focus on gas, and giant gas fields continue to be found.

Crude oil discoveries tend to be developed relatively quickly with most coming into production within five years of discovery (Powell 2004) and sometimes

within months if they are close to infrastructure (e.g. inshore fields in the Carnarvon Basin). Development of gas liquid (condensate and LPG) accumulations which now account for most of Australia's oil resources, on the other hand, can be delayed, sometimes for decades. Powell's 2004 analysis shows that most gas fields take 11 to 15 years from discovery to development. A high liquids content can accelerate development, although Ichthys with over 500 mmbbls of condensate and Australia's largest remaining oil field was discovered by the Brewster well in 1980 and is only now being assessed for development. Hence the oil resource outlook to 2030 is in part dependent on the rate of development of liquids-rich gas fields. Factors that may influence development timetables include market demand, environmental approvals, the challenge of any associated CO<sub>2</sub> and technological developments such as floating LNG facilities, discussed in Chapter 4.

### Discovery of new fields in non-producing and frontier basins

Frontier basins have a low level of exploration activity compared to established hydrocarbon basins. There are rank frontiers that have had no exploration drilling (for example, the Bremer Sub-basin) and other frontier areas where there has been only handful of wells drilled and major trends remain untested (for example, the Ceduna Sub-basin where only one well has been drilled in the main depocentre with others drilled on the margin, figure 3.41). In Australia's



**Figure 3.41** Sedimentary basins and petroleum exploration wells

Source: Geoscience Australia

poorly explored frontier basins many of the largest structures remain untested, and vast areas of sedimentary basins especially off the south-western, southern and eastern margins, have not been drilled. These offshore areas offer the greatest potential for major new oil discoveries. The deepwater Ceduna Sub-basin in the Great Australian Bight is considered to represent the highest probability for finding a new oil province (Totterdell et al. 2008) given the presence of an oil-prone source rock within a thick Cretaceous delta sequence.

Geoscience Australia is currently undertaking a program of pre-competitive data acquisition and interpretation to assess the petroleum potential of selected frontier basins. New seismic, potential field data and seabed samples have been collected from a number of offshore basins (Bight, Mentelle, Perth, Offshore Canning, Arafura, Otway and Sorell) to better understand the geological history and hydrocarbon resource potential of these areas. These studies have underpinned subsequent acreage release with uptake of exploration acreage in previously neglected areas (Bremer Sub-basin, Bight Basin; Vlaming Sub-basin, Perth Basin; Offshore Canning Basin and the Arafura Basin). Industry work in these new exploration permits is at an early stage; 2D and 3D seismic data have been acquired but exploration wells are yet to be drilled.

Geoscience Australia is also completing pre-competitive studies of two of the four basins in the remote deepwater frontier of the Lord Howe Rise. Early results have identified a number of depocentres that have sedimentary thickness (up to 7 km) and volume (100 km long and 30 km wide) sufficient to have potentially generated significant hydrocarbons if source rocks are present at depth (figure 3.31). While these structural results from new seismic acquisition are encouraging, no petroleum source rocks are known because the area has not been drilled for hydrocarbons. Pre-competitive data acquisition programs in the onshore frontier Amadeus, Georgina, Darling and Canning basins are being undertaken by Geoscience Australia in cooperation with relevant State Geological Surveys. The current programs are limited compared with the large size of these basins: both the Amadeus and Canning basins are proven oil producers and oil source rocks known from the Georgina Basin.

The size, number and geological diversity of Australia's frontier basins are consistent with major undiscovered petroleum resources being present. The petroleum resources likely to be discovered in the years to 2030 depend on the amount of exploration activity, the success rate, and the size of prospects. Current frontier exploration rates are low, averaging in the past decade less than 2 wells per year in the offshore and around 10 per year onshore (APPEA 2009) and are liable to remain so

without the stimulus supplied by access to regional pre-competitive data. Success rates in frontier basins can be as low as 10 per cent but can be improved with new information and new technologies and, as discussed above, prospect sizes can be large as the largest structures are yet to be drilled. Current low frontier drilling rates and low success rates make it unlikely that a frontier oil discovery will be made in any particular year. The only new oil province discovered last decade was the Abrolhos Sub-basin in the offshore Perth Basin, where the Cliff Head field was found in 2001 as an offshore example of a proven trend onshore. The offshore Exmouth Sub-basin, which has materially added to Australia's oil production, was already established as a proven hydrocarbon province with oil discoveries in the 1980s and 1990s.

A number of estimates of undiscovered hydrocarbon potential derived from a variety of methods are available for individual frontier basins and for Australia as a whole (Bradshaw et al. 1998; Longley et al. 2001). The publicly available assessments have not integrated the results from the current rounds of pre-competitive data acquisition. Even in deepwater frontier basins, oil discoveries can be expected to be developed within a few years using FPSOs, if they are of commercial size.

### Outlook for unconventional oils

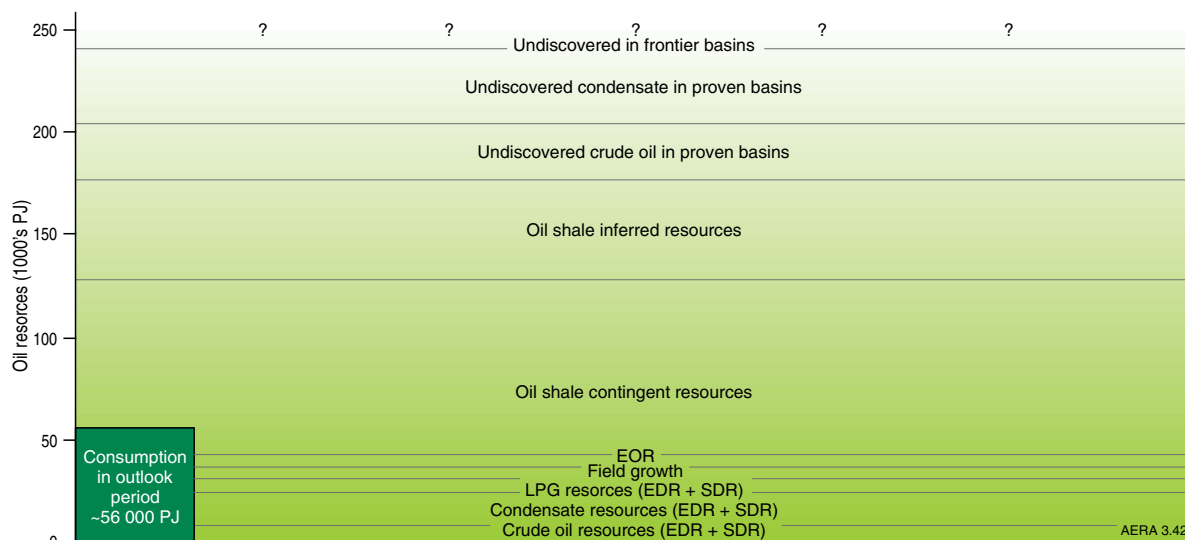
Oil shale contains a large unconventional oil resource for Australia. However there is currently no production. Some of the challenges for the oil shale industry include technical issues associated with achieving large scale commercial production in the face of uncertainty and volatility of future crude oil prices. There are also environmental challenges, including reducing CO<sub>2</sub> emissions and water usage, and issues associated with disposal of spent shale. These challenges need to be overcome and oil prices remain high for shale oil to contribute significantly to resources in the outlook period.

Other unconventional sources of liquid fuels include GTL and CTL technologies. While Australia has abundant gas and coal resources, it is not anticipated that these technologies will significantly add to liquid fuel supplies in the outlook period. Biofuels make a small contribution to current oil supply in Australia and even with expanded production are not expected to impact significantly on Australian oil production until second generation biofuels become available. Biofuels are discussed in more detail in Chapter 12.

### Total resource outlook

Figure 3.42 plots Australia's potential total oil resources, including known and undiscovered. The following section details the potential demands on these resources over the next twenty years.





**Figure 3.42** Total oil resources (identified and potential) and estimated cumulative consumption

**Source:** Geoscience Australia

There is no currently publicly available resource assessment of Australia’s undiscovered oil resources that adequately reflects the new knowledge gained in recent years during the active programs of government pre-competitive data acquisition and increased company exploration during the recent resource boom. The knowledge base for unconventional oil is at a low level.

### 3.4.3 Outlook for oil market

Without a major discovery, Australian oil production is expected to continue to decline over the next twenty years. In contrast, domestic oil consumption is projected to increase moderately over the same period, increasing the reliance on imports. ABARE’s latest long term projections for Australian energy production, consumption and trade include the impacts of the Renewable Energy Target (RET), a 5 per cent emissions reduction target and other existing government policies (ABARE 2010). These results are discussed in more detail below.

### Production

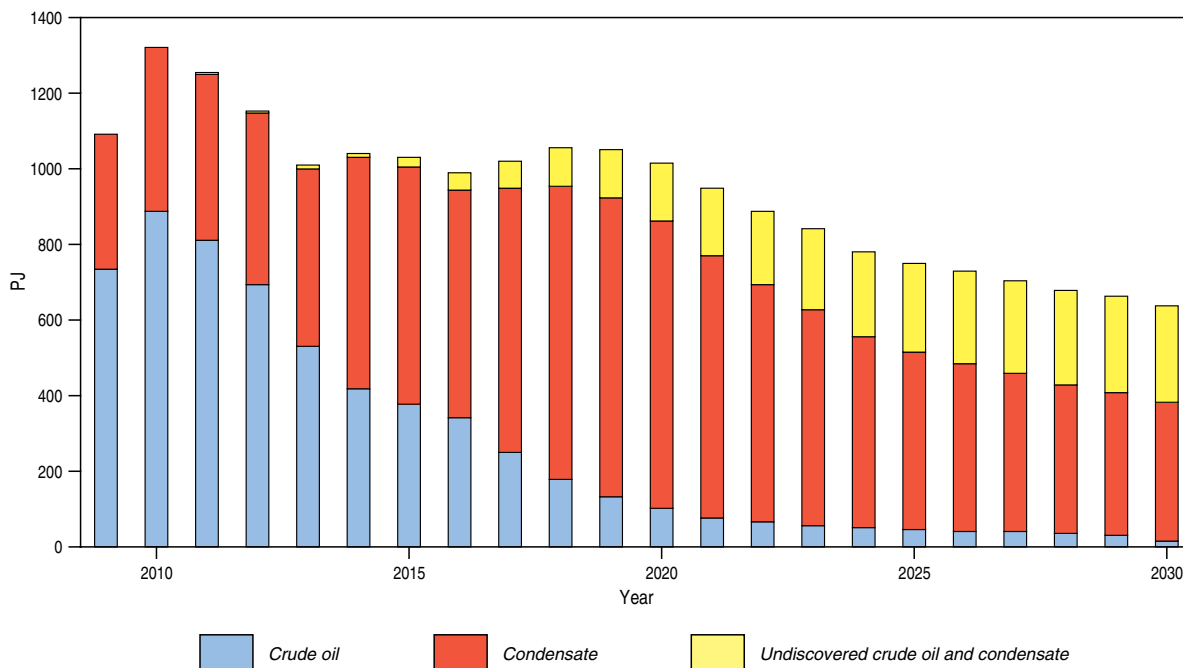
In the next few years, the production of oil in Australia is expected to rise as developments now under construction or in the advanced stages of planning are completed. However, beyond the medium term as far as 2029–30, combined crude oil and condensate production are expected to fall as older oil fields mature and slowly deplete. As with current production, the majority of future production is likely to be sourced from offshore basins in north-western Australia. Combined crude oil, condensate and LPG production is projected to fall gradually by 2.0 per cent per year to 668 PJ by 2029–30.

More detailed production forecasts by Geoscience Australia show that condensate is expected to outstrip crude oil production by about 2015 and new discoveries within the established basins could add to production in the later half of the outlook period (figure 3.43). Major new oil discoveries could reverse this trend, just as the discovery and development of new oil fields in the Carnarvon and Bonaparte basins replaced the declining production from the Gippsland

**Table 3.14** Outlook for Australia’s oil market to 2029–30

	unit	2029–30	Average annual growth, 2007–08 to 2029–30 %
Production of crude oil, condensate and LPG	PJ	668	-2.0
Consumption of crude oil, condensate and LPG	PJ	2443	1.8
Consumption of crude oil, condensate, LPG and oil products	PJ	2787	1.3
Share of primary energy consumption	%	36	
Net imports of crude oil and LPG	PJ	1775	5.0
Net imports of crude oil, LPG and petroleum products	PJ	2119	3.3

**Source:** ABARE 2010



**Figure 3.43** Australian oil production outlook from proven hydrocarbon basins

**Note:** the production forecast is based on data from an industry survey of producing fields and Geoscience Australia’s assessment of undiscovered resources in proven basins

**Source:** Geoscience Australia

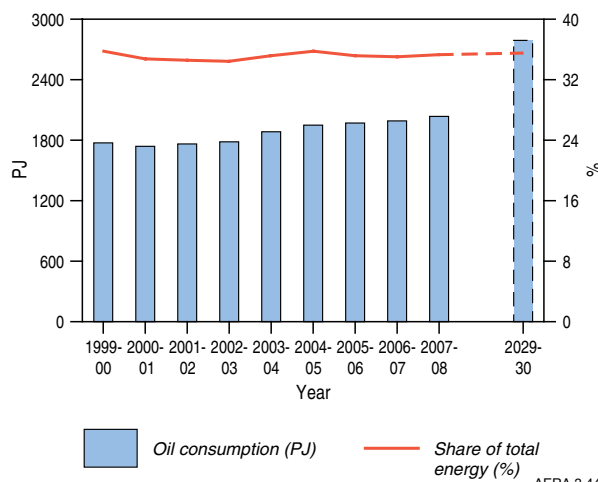
Basin in the late 1980s (Powell 2001). Frontier basins, such as the deep water Ceduna Sub-basin in the Great Australian Bight, are seen as offering the best chance for finding a major new oil province; increased frontier drilling rates would improve the likelihood of this outcome in the outlook period.

**Consumption**

Australia’s primary oil consumption is projected to grow faster than production. Total consumption of oil and oil products is projected to rise by 1.3 per cent per year to reach 2787 PJ in 2029–30, with a share in total primary energy consumption of 36 per cent in 2029–30 (figure 3.44, table 3.14).

In the short term, the global financial crisis and its adverse impact on economic growth is a contributor to the below-trend growth in consumption. The introduction of significant policy measures, namely the RET and a proposed emissions reduction target, are expected to lead to an increase in energy prices, and an associated dampening effect on demand. Partly offsetting this trend, economic growth in Australia is assumed to return to its long term potential as world economic performance improves. The decline in the growth rate for oil consumption in the final decade of the outlook period reflects primarily increasing carbon prices under the emission reduction target and lower economic growth assumptions.

The transport sector is expected to continue to rely heavily on oil over the next twenty years.



**Figure 3.44** Australia’s outlook for oil consumption

**Source:** ABARE 2009b; ABARE 2010

Consumption of oil and petroleum products in the transport sector is expected to grow steadily over the projection period at an average rate of 1.2 per cent per year driven largely by economic growth.

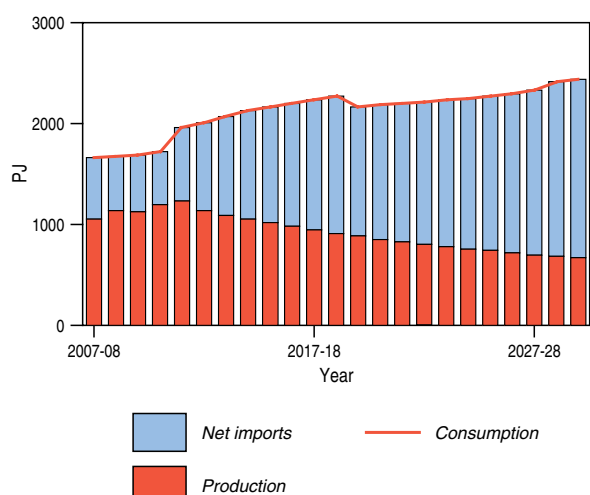
**Trade**

Continued growth in domestic oil demand and declining domestic oil production are expected to result in an increase in Australia’s oil imports over the next twenty years (figure 3.45).

Exacerbating this gap between supply and demand is the fact that a significant proportion of the growth



in domestic production of crude oil, condensate and naturally occurring LPG will be concentrated in the Carnarvon and Browse basins, in north western Australia. As a result, it is reasonable to assume that this supply of crude oil, condensate and naturally occurring LPG will largely be exported to Asia for processing, as opposed to supplied to the domestic market. As a result, the ability of domestic production to meet domestic demand is likely to be lower than implied by the simple comparison of production and consumption.



**Figure 3.45** Australia's oil supply–demand balance outlook

Source: ABARE 2010

The demand for petroleum product imports is not only determined by domestic oil production and end-use consumption of petroleum products, but also by domestic petroleum refining capacity. Australia's refining capacity is not expected to expand significantly given increasing competitive pressures from larger refineries in south-east Asia in particular. For a given domestic production and consumption outlook, petroleum refining capacity constraints may result in lower crude oil imports and, simultaneously, higher imports of refined products.

Reflecting this, Australia's net trade position for liquid fuels is expected to worsen over the outlook period, with net imports increasing by 3.3 per cent per year over the period to 2029–30.

### Major project developments

However, new oil fields continue to be brought on stream and at the end of October 2009, there were three offshore oil projects under construction (table 3.15). Two projects are located in the Carnarvon Basin and one project in the Bonaparte Basin in north-western Australia. These three projects have a combined peak oil production capacity of around 170 000 barrels a day at an estimated capital cost of around \$3.5 billion.

There are also three oil projects with a combined peak production capacity of up to 78 000 barrels a day at a less advanced stage of development (table 3.16). Two of these projects are located in offshore north-western Australia, and another project in the Gippsland Basin offshore Victoria.

**Table 3.15** Oil projects at an advanced stage of development, as at October 2009

Project	Company	Basin	Status	Start up	Capacity	Capital Expenditure (\$m)
Montara/Skua oilfield	PTTEP	Bonaparte	under construction	na	38 kbpd	US\$700 m (A\$843 m)
Van Gogh	Apache Energy/ Inpex	Carnarvon	under construction	2010	38 kbpd	US\$546 m (\$658 m)
Pyrenees	BHP Billiton/ Apache Energy	Carnarvon	under construction	2010	96 kbpd, 23 PJ pa gas	US\$1.68 b (A\$2 b)

Source: ABARE 2009d

**Table 3.16** Oil projects at a less advanced stage of development, as at October 2009

Project	Company	Basin	Status	Start up	Capacity	Capital Expenditure (\$m)
Basker, Manta and Gummy oil development	Roc Oil/Beach Petroleum	Gippsland	Expansion	na	10 kbpd	na
Crux liquids project	Nexus Energy/ Osaka gas	Browse	FEED study completed	na	38 kbpd condensate	US\$650 m (A\$783 m)
Talbot oil field	AED Oil	Bonaparte	Feasibility study under way	na	10–20 kbpd	na

Source: ABARE 2009d

### 3.5 References

- ABARE (Australian Bureau of Agricultural and Resource Economics), 2008, Australian Commodity Statistics 2008, Canberra
- ABARE, 2009a, Energy in Australia 2009, Canberra
- ABARE, 2009b, Australian Energy Statistics, Canberra, August
- ABARE, 2009c, Australian Commodities, vol.16, no.2, June quarter, Canberra
- ABARE, 2009d, Minerals and energy: Major development projects – October 2009 listing, ABARE, Canberra, November
- ABARE, 2010, Australian energy projections to 2029–30, ABARE research report 10.02, prepared for the Department of Resources, Energy and Tourism, Canberra
- ACIL Tasman, 2008, An assessment of Australia's liquid fuel vulnerability, report prepared for Department of Resources, Energy and Tourism, November 2008, <[http://www.ret.gov.au/energy/energy\\_security/emergency\\_response/liquid\\_fuel\\_emergency/lfe\\_vulnerability/Pages/lfe\\_vulnerability.aspx](http://www.ret.gov.au/energy/energy_security/emergency_response/liquid_fuel_emergency/lfe_vulnerability/Pages/lfe_vulnerability.aspx)>
- Anadarko, 2007, Record-setting Independence hub starts production, <<http://www.anadarko.com/Investor/Pages/NewsReleases/NewsReleases.aspx?release-id=1028609>>
- APPEA (Australian Petroleum Production and Exploration Association), 2009, State of the Industry. Attachment 2, APPEA submission to Energy White Paper, <[http://www.ret.gov.au/energy/facts/white\\_paper/list\\_of\\_sub/appea/Pages/default.aspx](http://www.ret.gov.au/energy/facts/white_paper/list_of_sub/appea/Pages/default.aspx)>
- Australian Bureau of Statistics, 2009, 8412.0 – Mineral and Petroleum Exploration, Australia, 2008 quarterly issues, <<http://www.abs.gov.au/ausstats/abs@.nsf/mf/8412.0>>
- Australian Institute of Petroleum, 2007, Downstream Petroleum 2007, <<http://www.aip.com.au/industry/dp2007/index.htm>>
- Australian Marine Safety Authority (AMSA), 2009, The national plan to combat pollution of the sea by oil and other noxious and hazardous substances, <[http://www.amsa.gov.au/Marine\\_Environment\\_Protection/National\\_Plan](http://www.amsa.gov.au/Marine_Environment_Protection/National_Plan)>
- Bradshaw MT, Foster CB, Fellows ME and Rowland DC, 1999, The Australian search for petroleum — patterns of discovery, The APPEA Journal, 39 (1), 1–18
- Branan N, 2008, Exploration and innovation: Geoscientists push the frontiers of unconventional oil and gas, <[http://www.jsge.utexas.edu/news/features/2008/exploration\\_innovation.html](http://www.jsge.utexas.edu/news/features/2008/exploration_innovation.html)>
- BP, 2009a, BP statistical review of world energy, London, June
- BP, 2009b, Tiber — drilling to new depths, <<http://www.bp.com>>
- Centre for Economics and Management (CEM), 2004, Oil and gas exploration and production: reserves, costs, contracts, Editions Technip, Paris
- Department of the Environment, Water, Heritage and the Arts (DEWHA), 2008, Current Marine Protected Areas of Australia, <<http://www.environment.gov.au/coasts/mpa/index.html>>
- Geoscience Australia, 2001, Oil and gas resources of Australia 2000, Geoscience Australia, Canberra
- Geoscience Australia, 2004, Oil and gas resources of Australia 2002, Geoscience Australia, Canberra
- Geoscience Australia, 2005, Oil and gas resources of Australia 2003, Geoscience Australia, Canberra
- Geoscience Australia, 2008, Oil and gas resources of Australia 2005, Geoscience Australia, Canberra
- Geoscience Australia, 2009a, Oil and Gas Resources of Australia 2008 Report, <[http://www.ga.gov.au/oceans/pgga\\_OGRA.jsp](http://www.ga.gov.au/oceans/pgga_OGRA.jsp)>
- Geoscience Australia, 2009b, Australia's Identified Mineral Resources 2009. Geoscience Australia, Canberra, <[https://www.ga.gov.au/products/servlet/controller?event=GEOCAT\\_DETAILS&catno=69951](https://www.ga.gov.au/products/servlet/controller?event=GEOCAT_DETAILS&catno=69951)>
- Hashimoto T, Rollet N, Higgins K, Bernardel G and Hackney R, 2008, Capel and Faust basins: Preliminary assessment of an offshore deepwater frontier region, in: JE Blevin, BE Bradshaw, and C Uruski (eds), Eastern Australasian Basins Symposium III: Energy security for the 21st century, Petroleum Exploration Society of Australia Special Publication, 311–316
- Hogan L, Thorpe S, Zheng S, Ho Trieu L, Fok G and Donaldson K, 1996, Net Economic Benefits from Australia's Oil and Gas Resources: Exploration, Development and Production, ABARE Research Report 96.4, Canberra
- International Energy Agency (IEA), 2007, Energy technologies at the cutting edge, Paris
- IEA, 2008, World energy outlook 2008, Paris
- IEA, 2009a, Oil information, 2009 edition, IEA online data services, OECD, Paris
- IEA, 2009b, World Energy Balances, 2009 edition, IEA online data services, OECD, Paris
- IEA, 2009c, World energy outlook 2009, Paris
- Johnson RC, Mercier TJ, Brownfield ME, Pantea MP and Self JG, 2009, Assessment of in-place oil shale resources of the Green River Formation, Piceance Basin, western Colorado: U.S. Geological Survey Fact Sheet 2009–3012
- Jones PE, 1988, Oil: A practical guide to the economics of world petroleum, Woodhead-Falkener, Cambridge, UK
- Klett TR and Gautier DL, 2003, Characteristics of reserves growth in oil fields of the North Sea Graben area, Paper Z-99.4, EAGE 65th Conference and Exhibition, Stavanger, Norway, 2–5 June
- Longley IM, Bradshaw MT and Heberberger J, 2001, Australian Petroleum Provinces of the 21st Century, in: M Downey, J Threet and W Morgan (eds.), Petroleum Provinces of the 21st Century, AAPG Memoir 74
- Longley IM, Buessenschuett C, Clydsdale L, Cubitt CJ, Davis RC, Johnson MK, Marshall NM, Murray AP, Somerville R, Spry TB and Thompson NB, 2002, The North West Shelf of Australia – a Woodside perspective. In: Keep M and Moss SJ, (editors), The Sedimentary Basins of Western Australia 3: Proceedings of the Petroleum Exploration Society of Australia Symposium, Perth, 27–88
- Magoon LB and Dow WG, 1994, The petroleum system. In Magoon LB and Dow WG, (editors) The petroleum system – from source to trap. AAPG Memoir 60, AAPG, Tulsa, USA, 3–24
- McCabe PJ, 1998, Energy resources — Cornucopia or empty barrel? American Association of Petroleum Geologists Bulletin, V 82, no. 11, 2110–2134

McFarland JD, 2001, Shale oil — a new production development paradigm, *The APPEA Journal*, 47 (1), 663–670

Ozmic S and Saxby JD, 1983, Oil Shale Methodology: An examination of the Toolebuc Formation and the laterally contiguous time equivalent units, Eromanga and Carpentaria Basins. Bureau of Mineral Resources and CSIRO research project

Powell TG, 2001, Understanding Australia's petroleum resources, future production trends and the role of the frontiers, *The APPEA Journal*, 41 (1), 273–288

Powell TG, 2004, Australia's hydrocarbon resources — where will future production come from? *The APPEA Journal*, 44 (1), 729–740

Santos, 2009, Moomba Carbon storage project, <<http://www.santos.com/activities-browser/moomba-carbon-storage-project.aspx>>

Shell, 2009, Perdido, <[http://www.shell.com/home/content/aboutshell/our\\_strategy/major\\_projects\\_2/perdido/perdido\\_13032008.html](http://www.shell.com/home/content/aboutshell/our_strategy/major_projects_2/perdido/perdido_13032008.html)>

Totterdell JM, Struckmeyer HIM, Boreham CJ, Mitchell CH, Monteil E and Bradshaw BE, 2008, Mid-Late Cretaceous organic-rich rocks from the eastern Bight Basin: implications for prospectivity. In: Blevin, JE, Bradshaw, BE and Uruski, C (eds), *Eastern Australasian Basins Symposium III*, Petroleum Exploration Society of Australia, Special Publication, 137–158

USDOE (United States Department of Energy), 2007, Secure fuels from domestic resources: The continuing evolution of America's oil shale and tar sands industries. Profiles of companies engaged in domestic oil shale and tar sands resource and technology development. Office of Petroleum Reserves, Office of Naval Petroleum and Oil Shale Reserves, June

USGS (United States Geological Survey) Geological Survey World Energy Assessment Team, 2000, US Geological Survey World Petroleum Assessment 2000 – Description and results. USGS Digital Data Series DDS-60

Walker TR, 2007, Deepwater and frontier exploration in Australia – historical perspectives, present environment and likely future trends. *The APPEA Journal*, 47 (1), 1–15

Wilkinson R, 2006, Speaking oil and gas, BHP Billiton Petroleum, Australia

Williamson PE and Kroh F, 2007, The role of amplitude versus offset technology in promoting offshore petroleum exploration in Australia, *The APPEA Journal*, 47 (1), 161–174

Wright D, Le Poidevin S and Morrison G, 1990, Potential from enhanced oil recovery applications in Australia. Bureau of Mineral Resources Record 1991/20, Canberra

WEC (World Energy Council), 2007, 2007 Survey of energy resources, World Energy Council, London, United Kingdom

WEC, 2009, Survey of energy resources, interim update 2009. World Energy Council, London, United Kingdom

# Chapter 4 Gas



## 4.1 Summary

### KEY MESSAGES

- Australia has significant gas resources; gas is Australia's third largest energy resource after coal and uranium.
- Most of the conventional gas resources are located off the north-west coast of Australia and are being progressively developed for LNG export and domestic use.
- Significant coal seam gas resources exist in the major coal basins of eastern Australia and are being developed for domestic use and potential export.
- Australia's gas resources are large enough to support projected domestic and export market growth beyond 2030 and are to expected grow further.
- Gas is a relatively flexible and clean energy source and is projected to be the fastest growing fossil fuel over the period to 2030.
- Gas is expected to significantly increase its share of Australia's energy production and exports, and make a substantially greater contribution to electricity generation.

### 4.1.1 World gas resources and market

- Gas is the third largest global energy source, currently accounting for around 21 per cent of global primary energy consumption. Global gas consumption has increased by 2.8 per cent per year since 2000, to reach 121 280 PJ (107 tcf) in 2008.
- Global LNG trade has expanded even more rapidly – by 6.1 per cent per year since 2000 – to reach 8850 PJ (168 Mt, 8 tcf) in 2008. LNG trade accounts for around 7 per cent of global gas consumption.
- Global gas proved reserves are estimated to have been around 7.2 million PJ (6534 tcf) at the end of 2008. This is equal to more than 60 years' supply at current production rates. While information is limited, global unconventional gas resources in place are estimated to be more than four times this amount, in the order of 35.8 million PJ (32 500 tcf).
- Australia accounted for nearly 2 per cent of world gas reserves and production in 2008. However, Australia is the world's sixth largest LNG exporter and accounted for 9 per cent of world LNG trade in 2008.
- Global gas demand is projected by the International Energy Agency (IEA) in its reference case to increase by 1.5 per cent per year to reach 149 092 PJ (132 tcf) in 2030.

- This expansion in global demand will increasingly be met by imports, including LNG from countries such as Australia. Global LNG trade is projected by the IEA to rise by 3.7 per cent per year to reach 17 104 PJ (314 Mt, 15 tcf) in 2030.
- The recent rapid growth in unconventional gas resources and production worldwide could reduce LNG export opportunities in some markets but is likely to have less impact on Asian markets.

### 4.1.2 Australia's gas resources

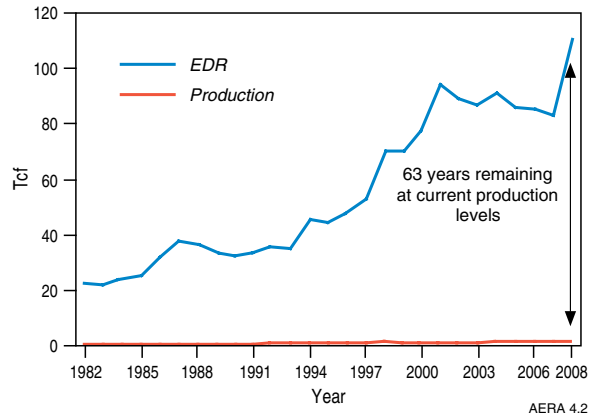
- Gas is Australia's third largest energy resource after coal and uranium. This is unlikely to change in the period leading up to 2030.
- Most (around 92 per cent) of Australia's conventional gas resources are located in the Carnarvon, Browse and Bonaparte basins off the north-west coast. There are also resources in south-west, south-east and central Australia. Large coal seam gas (CSG) resources exist in the coal basins of Queensland and New South Wales. Tight gas accumulations are located in onshore Western Australia and South Australia, while potential shale gas resources are located in the Northern Territory (figure 4.1).
- In 2008, Australia's economic demonstrated resources (EDR) and subeconomic demonstrated resources (SDR) of conventional gas were estimated at 180 400 PJ (164 tcf). At current

production rates there are sufficient EDR (122 100 PJ, 111 tcf) of conventional gas to last another 63 years (figure 4.2).

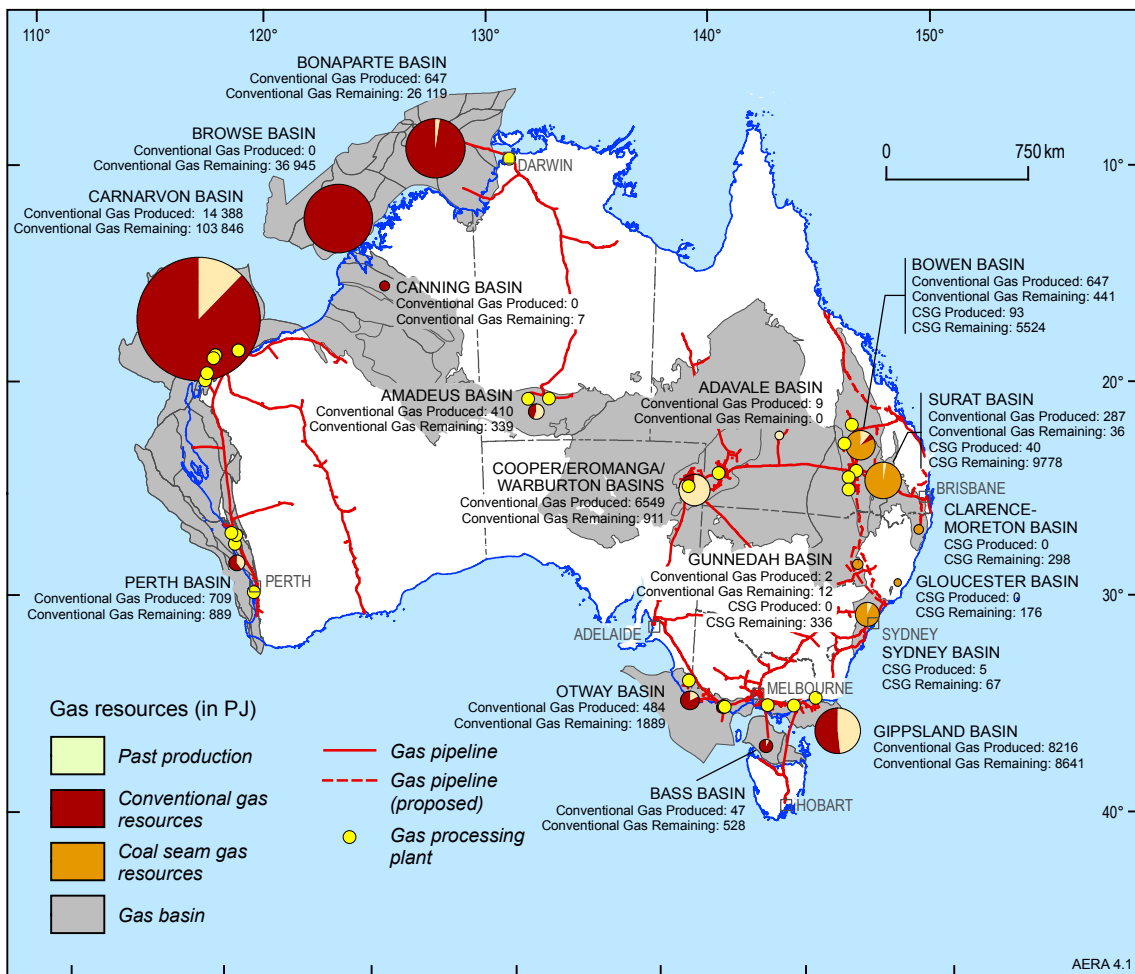
- In addition there is a possible 22 000 PJ (20 tcf) of inferred conventional gas resources in recently discovered fields and other fields not booked as part of EDR and SDR.
- Gas exploration has a sustained record of success, with the strong likelihood of finding more conventional gas resources. Field growth and new discoveries will help offset increasing production so that identified conventional gas resources in 2030 will remain substantial and capable of supporting several decades of future production.
- Australia also has significant unconventional gas resources – CSG, tight gas and shale gas. Coal seam gas economic demonstrated resources (EDR) at the end of 2008 were 16 590 PJ (15.1 tcf), smaller recoverable resources than several of Australia’s individual conventional gas fields but equal to more than 100 years of CSG production at current rates. Total identified resources of CSG are estimated to be around

168 600 PJ (153 tcf), including sub-economic resources (SDR) estimated at 30 000 PJ (27.3 tcf) and inferred of 122 020 PJ (111 tcf).

- Tight gas resources are estimated at around 22 000 PJ (20 tcf). Australia may also have significant but as yet unquantified shale gas resources. No reserves of tight gas or shale gas are currently booked.



**Figure 4.2** Conventional gas resources and production  
**Source:** Geoscience Australia 2009



**Figure 4.1** Location of Australia’s gas resources and infrastructure  
**Source:** Geoscience Australia



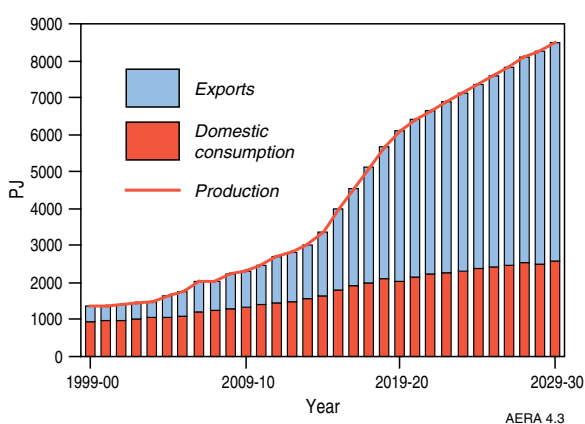
- Total identified gas resources are sufficient to enable significant expansion in Australia's domestic and export production capacity. Australia's combined identified gas resources are in the order of 393 000 PJ (357 tcf). This is equal to around 180 years of gas at current production rates, of which EDR accounts for 67 years.
- The distribution of gas resources in 2030 is expected to follow a similar pattern with substantial conventional gas resources offshore and unconventional resources identified across several onshore basins.

#### 4.1.3 Key factors in utilising Australia's gas resources

- Most of Australia's conventional gas resources are located offshore far from domestic gas markets, which affects the costs of bringing the resource to market.
- Development of secure long-term markets is necessary to underpin the major capital investment required for development of the offshore gas resources of north-west Australia.
- Potential environmental issues raised by gas development may include the disposal of water produced from onshore coal seam gas operations and carbon dioxide contained in some large offshore gas fields.
- New gas pipelines will be required, particularly in eastern Australia, to provide sufficient supply for new gas-fired electricity generation in response to demand for cleaner energy.

#### 4.1.4 Australia's gas market

- Australian gas consumption has grown by 4 per cent per year over the past decade. Gas



**Figure 4.3** Outlook to 2030 for the Australian gas market

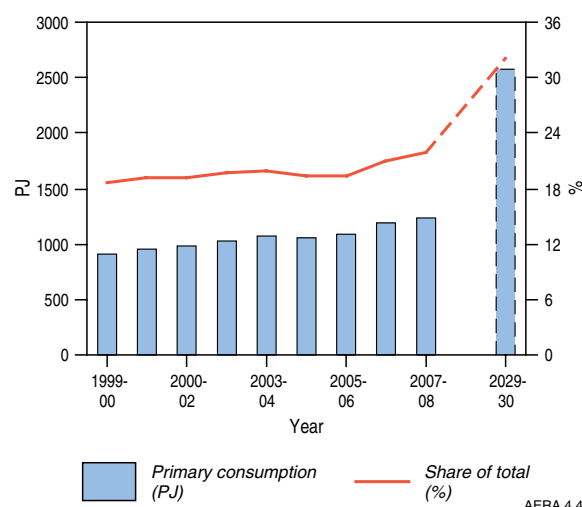
Source: ABARE 2009a, 2010

accounted for 22 per cent (1249 PJ) of Australia's primary energy consumption in 2007–08, and 16 per cent of electricity generation.

- The main gas users in Australia are the manufacturing, electricity generation, mining and residential sectors.
- The expansion in gas production over this period has been even stronger. Gas production was 1833 PJ (1.6 tcf) in 2007–08. Unconventional gas production, in the form of coal seam gas, accounted for 7 per cent of this production. No tight or shale gas is currently produced in Australia.
- Around 44 per cent (802 PJ, 14.3 Mt) of Australian gas production was exported as LNG, valued at \$5.9 billion, in 2007–08. Higher export volumes and international oil prices increased the value of exports in 2008–09 to \$10.1 billion.

#### 4.1.5 Outlook to 2030 for the Australian gas market

- Growth in gas consumption is expected to be driven by investment in new gas-fired power generation and by policy initiatives supporting gas uptake as a relatively clean energy source.
- An emissions reduction target is expected to enhance the role of gas as a transitional fuel to a low carbon economy. Gas-fired electricity generation has lower carbon emissions than coal-fired electricity without carbon capture and storage, and can also be linked with intermittent renewable energy resources such as wind to provide a flexible and reliable power source.
- Demand for LNG is likely to grow in overseas markets, driven by similar factors to those in Australia.



**Figure 4.4** Outlook to 2030 for Australian gas consumption

Source: ABARE 2009a, 2010



- In ABARE's latest long-term projections which include a 5 per cent emissions reduction target, the Renewable Energy Target and other government policies, gas consumption in Australia is projected to increase by 3.4 per cent per year to reach 2575 PJ (2.3 tcf) in 2029–30. Its share of primary energy consumption is projected to rise to 33 per cent in 2029–30 (figures 4.3 and 4.4).
- Australian gas production is projected to reach 8505 PJ (7.7 tcf) in 2029–30. Coal seam gas is projected to account for 29 per cent of this total.
- LNG exports are expected to account for around 70 per cent of Australian gas production in 2029–30, with exports projected to increase to 5930 PJ (109 Mt) in 2029–30. As well as the major announced and potential LNG developments in north-west Australia, there are well-advanced plans to export coal seam gas as LNG from Queensland in the next decade.

## 4.2 Background information and world market

### 4.2.1 Definitions

**Natural gas** is a combustible mixture of hydrocarbon gases. It consists mainly of methane ( $\text{CH}_4$ ), with varying levels of heavier hydrocarbons and other gases such as carbon dioxide. Natural gas is formed by the alteration of organic matter (box 4.1). When accumulated in a subsurface reservoir that can be readily produced it is known as **conventional gas**. Conventional gas can also be found with oil in oil fields. Conventional gas fields can be **dry** (almost pure methane) or **wet** (associated with the 'wet gas' components – ethane, propane, butanes and condensate). Dry gas has a lower energy content than wet gas. Natural gas can also be found in more difficult to extract **unconventional** deposits, such as coal beds

#### BOX 4.1 NATURAL GAS CHEMISTRY AND FORMATION

Natural gas is composed of a mixture of combustible hydrocarbon gases (figure 4.5). These include methane ( $\text{CH}_4$ ), ethane ( $\text{C}_2\text{H}_6$ ), propane ( $\text{C}_3\text{H}_8$ ), butane ( $\text{C}_4\text{H}_{10}$ ) and condensate ( $\text{C}_{5+}$ ). Most natural gas is methane but because of the variable additions of the heavier hydrocarbons, gas accumulations vary in their energy content and value (Appendix E).

Liquefied Natural Gas (LNG) is primarily composed of the lightest hydrocarbons, methane ( $\text{CH}_4$ ) and ethane ( $\text{C}_2\text{H}_6$ ). It is produced by cooling natural gas to around  $-160^\circ\text{C}$  where it condenses to a liquid taking up about 1/600th the volume of natural gas in the gaseous state.

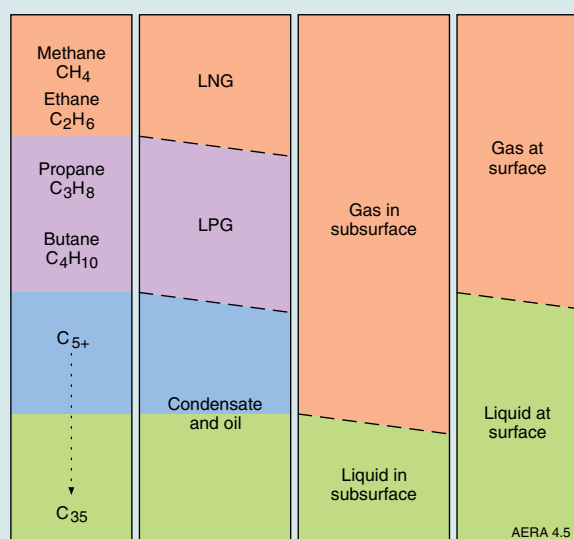
Liquefied Petroleum Gas (LPG) is a mixture of the light hydrocarbons propane ( $\text{C}_3\text{H}_8$ ) and butane ( $\text{C}_4\text{H}_{10}$ ) and it is normally a gas at surface conditions,

though it is stored and transported as a liquid under pressure (for example in domestic barbecue gas bottles). Condensate is a mixture of pentane ( $\text{C}_5\text{H}_{12}$ ) and heavier hydrocarbons that condense at the surface when a gas accumulation is produced. The gas liquids, LPG and condensate, are discussed in Chapter 3 (Oil).

Natural gas is formed by the alteration of organic matter. This can occur through biogenic or thermogenic processes. The bacterial decomposition of organic matter in oxygen-poor environments in the shallow subsurface produces biogenic gas, for example landfill gas – see Chapter 12 (Bioenergy). Biogenic gas is very 'dry', being almost pure methane.

Thermogenic natural gas is derived from the thermal alteration of organic matter buried deep within sedimentary basins over geological time. Thermogenic gas is generated with oil as the organic matter is heated and buried; with further burial and heating, oil will be 'cracked' to gas and pyrobitumen. Hence, natural gas is preserved within a sedimentary basin over a greater depth and temperature range than oil.

There are isotopic methods to distinguish biogenic from thermogenic gas. Evidence of thermogenic gas indicates that a petroleum system is working and leaves open the possibility that oil may also occur. Most Australian conventional gas accumulations are considered to be thermogenic in origin (Boreham et al. 2001), though some of the dry gas accumulations such as Tubridgi in the onshore Carnarvon Basin (Boreham et al. 2008) have a biogenic source input. A significant biogenic contribution is recognised in Australian coal seam gas (Draper and Boreham 2006).



**Figure 4.5** Petroleum resources nomenclature in terms of chemical composition, commercial product, physical state in the subsurface and physical state at the surface

Source: Geoscience Australia

(coal seam gas), or in shales (shale gas), low quality reservoirs (tight gas), or as gas hydrates (box 4.2).

**Coal seam gas (CSG)** is naturally occurring methane gas in coal seams. It is also referred to as coal seam methane (CSM) and coal bed methane (CBM). Methane released as part of the coal mining operations is called coal mine methane (CMM). Coal seam gas is dry gas, being almost entirely methane with the gas molecules remaining adsorbed in the coal rather than migrating to a conventional gas reservoir.

**Tight gas** occurs within low permeability reservoir rocks, that is rocks with matrix porosities of 10 per cent or less and permeabilities of 0.1 millidarcy (mD) or less, exclusive of fractures (Sharif 2007). Tight gas can be regionally distributed (for example, basin-centred gas), or accumulated in a smaller structural closure as in conventional gas fields.

**Shale gas** is natural gas which has not migrated to a reservoir rock but is still contained within low permeability, organic-rich source rocks such as shales and fine-grained carbonates.

**Gas hydrates** are a potential unconventional gas resource. Gas hydrates are naturally occurring ice-like solids (clathrates) in which water molecules trap gas molecules in deep-sea sediments or in and below the permafrost soils of the polar regions.

**Liquefied natural gas (LNG)** is natural gas that is cooled to around  $-160^{\circ}\text{C}$  until it forms a liquid, to make it easier and cheaper to transport long distances in LNG tankers to markets.

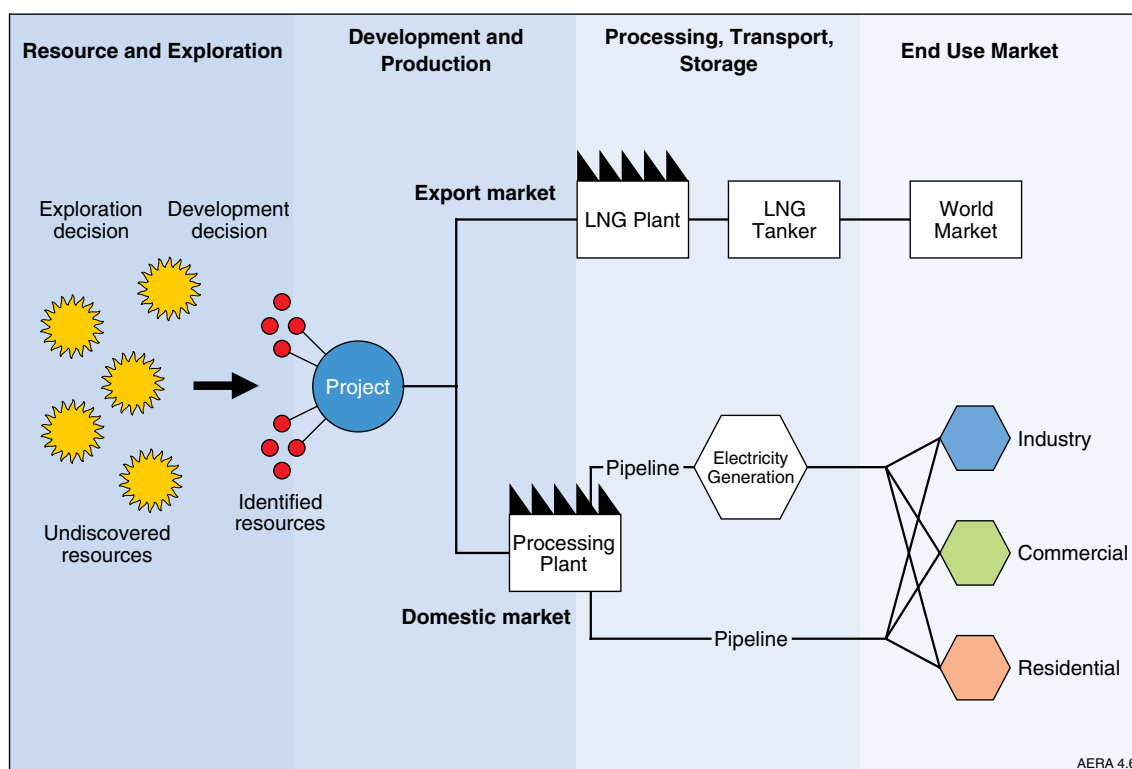
As an end-use product, unconventional gas is similar to conventional natural gas. It can be added to natural gas pipelines without any special treatment and utilised in all natural gas applications such as electricity generation and commercial operations.

#### 4.2.2 Gas supply chain

Figure 4.6 illustrates the simplified operation of the gas industry in Australia. Resources are delivered to domestic and export markets through the successive activities of exploration, development, production, processing and transport. While different technologies can be used for extracting CSG and other unconventional gas, once extracted it is indistinguishable from conventional natural gas, and the supply chain is the same.

##### Resources and exploration

Exploration for conventional gas follows the same process as for oil. Geoscientists identify areas where hydrocarbons are liable to be trapped in the subsurface, that is in sedimentary basins of sufficient thickness to contain mature petroleum source rocks as well as suitable reservoir and seal rocks in trap configurations. The search narrows from broad regional geological studies through to determining an individual drilling target. Reflection seismic is the primary technology used to identify likely hydrocarbon-bearing structures in the subsurface (figure 4.7). There must also be evidence of a working petroleum system (box 4.2). Such evidence includes the presence of other petroleum discoveries in the case of a proven basin, or indications of the presence of organic-rich rock to act as a gas



**Figure 4.6** Australia's gas supply chain

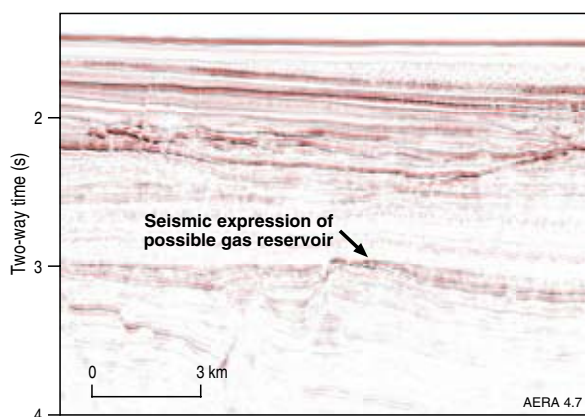
Source: ABARE and Geoscience Australia

source in the case of frontier basins. Drilling is required to test whether the putative hydrocarbon trap contains oil or gas, both, or neither. Successful wells are commonly tested to recover a sample of the hydrocarbons for analysis to determine gas quality (liquids content, presence of CO<sub>2</sub>) and to determine likely production rates. The initial discovery well may be followed by appraisal drilling and/or the collection of further survey data to help determine the extent of the accumulation.

In Australia, government has taken a key role in providing regional pre-competitive data to encourage private sector investment in exploration. Company access to prospective exploration areas is by competitive bidding, usually in terms of proposed work program, or by taking equity ('farming-in') in existing acreage holdings.

Exploration for unconventional gas differs somewhat from the search for conventional hydrocarbons, especially when the target is a broadly distributed stratigraphic formation such as a coal bed or shale. Seismic surveys and drilling still constitute the major exploration technologies. However, the distribution of the prospective formation is usually well known at the regional scale, and exploration success depends on identifying parts of the formation where the gas resource and reservoir quality are sufficient to sustain a flow of gas on a commercial scale.

Most of Australia's conventional gas exploration occurs in the offshore basins, sometimes in water depths beyond 1000 m and with target depths from about 2000 to over 4000 m below the sea floor. The search for CSG, tight gas and shale gas is restricted to onshore basins and target depths range from a few hundred metres to about 1000 m. The costs of the different exploration components – especially seismic and drilling – vary markedly depending on the scope and location of the project, logistics, and other factors. Many shallow onshore CSG wells can be drilled for the cost of one deep well in deep water.



**Figure 4.7** Seismic section across a prospective gas accumulation on the Exmouth Plateau, Carnarvon Basin  
**Source:** Williamson and Kroh 2007

For example, an offshore well drilled to 3000–4000 m in water depth of 100–200 m typically costs \$30–50 million (roughly \$1 million per day of drilling), depending on location, water depth and other considerations. Shallow wells drilled to 200–1000 m in CSG exploration and development typically cost around \$300 000 to \$1 million (around \$1000 per metre) with an average cost of around \$500 000 per well (company reports and Geoscience Australia estimates).

### Development and production

Once a decision to proceed has been made and financial and regulatory requirements addressed, infrastructure and production facilities are developed. For offshore conventional gas accumulations this involves the construction of production platforms with the gas piped to onshore processing plants, although there are proposals to develop some remote gas fields with floating LNG processing facilities on-site. Production of CSG resources requires the drilling of many shallow wells and removal of water to de-pressurise the coal formation before gas flow is established. Hydraulic fracturing combined with horizontal drilling is used to achieve commercial flow rates from tight gas and shale gas formations.

### Processing, transport and storage

The gas extracted from the well requires processing to separate the sales gas from other liquids and gases that may be present, and to remove water, carbon dioxide and other impurities before it can be transported efficiently by pipeline or ship. As a result, processing tends to occur near the production well.

Apart from small quantities used on site for electricity generation or other purposes, gas usually requires transport for long distances to major markets. This is managed in Australia by gas pipeline (for domestic use), and in liquefied form (LNG) by tanker (for export). Gas in pipelines travels at high pressures, which reduces the volume of the gas being transported as well as providing the force required to move through the pipeline. LNG is natural gas that has been cooled to around -160°C at which temperature it becomes a liquid and has shrunk in volume some 600 times. Liquefaction reduces the volume and the cost of transportation over long distances. However, it typically consumes 10–15 per cent of the gas in the process.

Natural gas not used immediately can be placed in storage until it is needed. Normally, it is stored underground in large reservoirs, but can also be stored in liquefied form. Gas can be reinjected into depleted reservoirs for later use following the extraction of oil and other liquids.

### End use market

While major industrial users and electricity generators tend to receive natural gas directly, most users receive gas through distribution companies. As an

**BOX 4.2 PETROLEUM SYSTEMS AND RESOURCE PYRAMIDS**

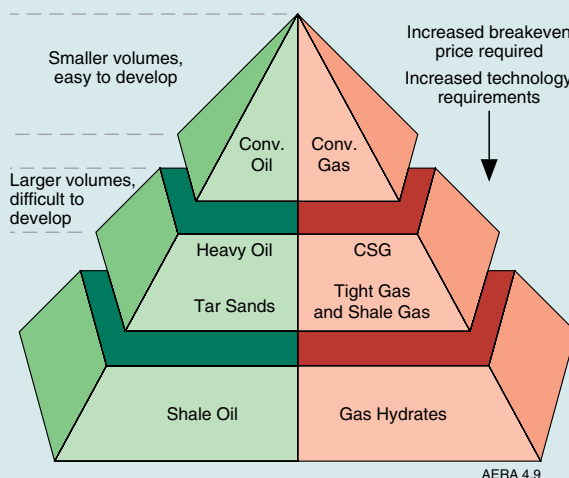
Conventional accumulations of oil and gas are the products of a ‘petroleum system’ (Magoon and Dow 1994). The critical elements of a petroleum system (figure 4.8) are:

- source – an organic-rich rock, such as an organic-rich mudstone;
- reservoir – porous and permeable rock, such as sandstone;
- seal – an impermeable rock such as a shale;
- trap – a sub-surface structure that contains the accumulation, such as a fault block or anticline;
- overburden – sediments overlying the source rock required for its thermal maturation; and
- migration pathways to link the mature source to the trap.

In addition to these static elements, the actual processes involved – trap formation, hydrocarbon generation, expulsion, migration, accumulation and preservation – must occur, and in the correct order, for the petroleum system to operate successfully and gas and oil accumulations to be formed and preserved.

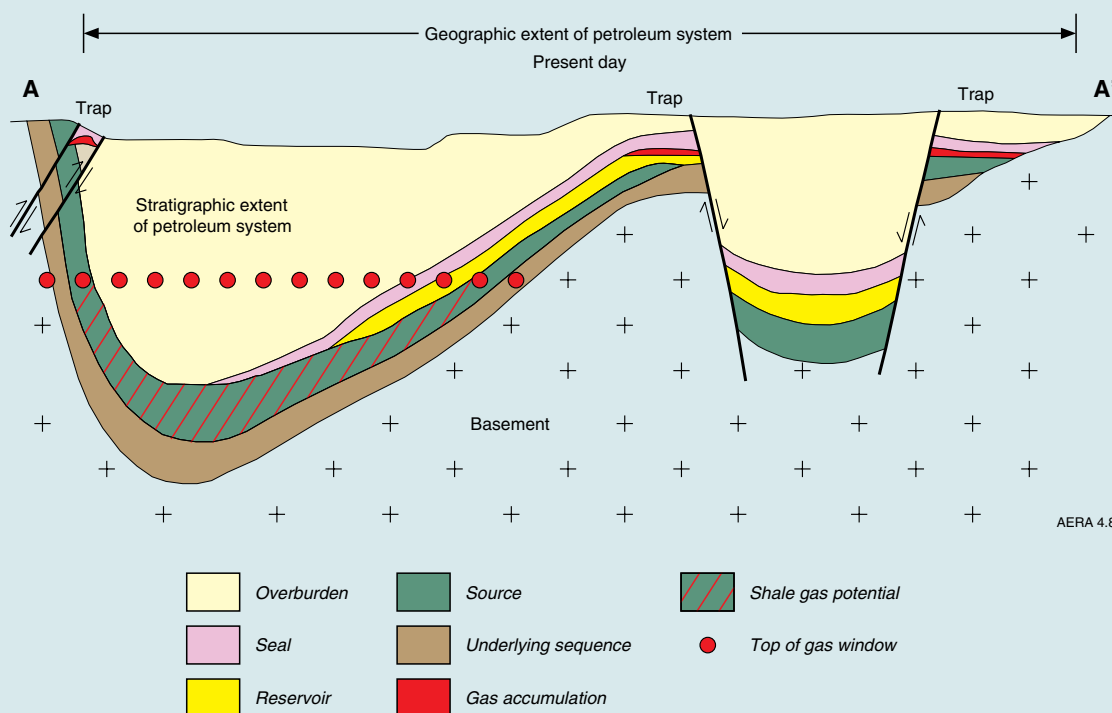
Unconventional gas accumulations reflect the failure or under-performance of the petroleum system. Shale gas and coal seam gas arise where the natural gas is still within the source rock, not having migrated to a porous and permeable reservoir. Tight gas accumulations are within a poor quality reservoir. The petroleum resource pyramid (McCabe 1998) illustrates how a smaller volume of easy to extract conventional gas and oil is underpinned by larger volumes of more difficult and more costly to

extract unconventional gas and oil (figure 4.9). For the unconventional hydrocarbon resources additional technology, energy and capital has to be applied to extract the gas or oil, replacing the action of the geological processes of the petroleum system. Technological developments and rises in price can make the lower parts of the resource pyramid accessible and commercial to produce. The recent development of oil sands in Canada and of shale gas in the United States are examples where rising energy prices and technological development has facilitated the exploitation of unconventional hydrocarbon resources lower in the pyramid.



**Figure 4.9** Petroleum resource pyramid

Source: Geoscience Australia, adapted from McCabe 1998 and Branan 2008



**Figure 4.8** Petroleum system elements

Source: Modified after Magoon and Dow 1994

end-use product, unconventional gas may be added to gas pipelines without any special treatment and utilised in all gas appliances and commercial applications.

### 4.2.3 World gas market

Table 4.1 provides a snapshot of the Australian gas market within a global context. Australian reserves account for only a small share of global reserves, and Australia is a relatively small producer and consumer. However, natural gas reserves are significant at the national level, and natural gas plays an important role in the Australian energy mix. Australia has also emerged as a significant player in world LNG trade.

#### Reserves and production

Proved world gas reserves – those quantities that geological and engineering information indicates with reasonable certainty can be recovered in the future from known reservoirs under existing economic and operating conditions – were estimated to be more

than 7.2 million PJ (6534 tcf) at the end of 2008. At current rates of world production, this is sufficient for more than 60 years (BP 2009). The Russian Federation, Iran and Qatar together hold more than half of the world's proved gas reserves (figure 4.10). Australia accounts for around 1.7 per cent of global reserves (table 4.1).

The IEA estimates that there are nearly 15.7 million PJ (14 285 tcf) of remaining recoverable resources of conventional gas. This is equivalent to almost 130 years of production at current rates (IEA 2009c).

World gas production in 2008 was estimated at 120 711 PJ (107 tcf). The largest gas producers are the Russian Federation and the United States. Australia is the world's nineteenth largest gas producer, accounting for around 1.5 per cent of world gas production (IEA 2009b, figure 4.10).

#### Consumption

Natural gas currently accounts for around 21 per cent of world primary energy consumption. World gas

**Table 4.1** Key gas statistics, 2008

	Unit	Australia 2007–08	Australia 2008	OECD 2008	World 2008
<b>Reserves</b>	PJ	-	122 100	645 700	7 187 400
	tcf	-	111	587	6534
Share of world	%	-	1.7	9	100
World ranking	no.	-	14	-	-
<b>Production</b>	PJ	1833	1832	44 773	120 711
	tcf	1.6	1.6	40	107
Share of world	%	-	1.5	37	100
World ranking	no.	-	19	-	-
Annual growth in production 2000–2008	%	4.2	4.1	0.7	2.8
<b>Primary energy consumption</b>	PJ	1249	1351	59 992	121 280
	tcf	1.1	1.2	53	107
Share of world	%	-	1.1	49	100
World ranking	no.	-	27	-	-
Share of total primary energy consumption	%	21.6	20.5	23.7	20.9
Annual growth in consumption 2000–2008	%	4.0	5.3	1.4	2.8
<b>Electricity generation</b>	TWh	-	42	2343	4127
Share of total	%	-	15.9	22.0	20.9
<b>Export</b>					
LNG export volume	Mt	14.3	15.0	146	168
	tcf	0.7	0.7	7.0	8.0
Share of world	%	-	8.9	87	100
World ranking	no.	-	6	-	-
LNG export value	A\$b	5.9	9.2	-	-
Annual growth in export volume 2000–08	%	-	8.5	-	6.1

**Note:** World share of total primary energy consumption and electricity generation are 2007 data; Australian production excludes imports from Joint Petroleum Development Area (JPDA)

**Source:** BP 2009; IEA 2009a, b; ABARE 2009a, b



consumption has grown steadily over the past few decades, by around 2.9 per cent per year between 1971 and 2008 (IEA 2009b). Contributing factors include increased emphasis on environmental issues, which favours the clean combustion properties of gas relative to other fossil fuels, the uptake of technologies such as integrated gas combined cycle power plants, and the commercialisation of abundant gas reserves. Energy security and fuel diversification policies have helped encourage gas demand as a means of reducing dependence on imported oil.

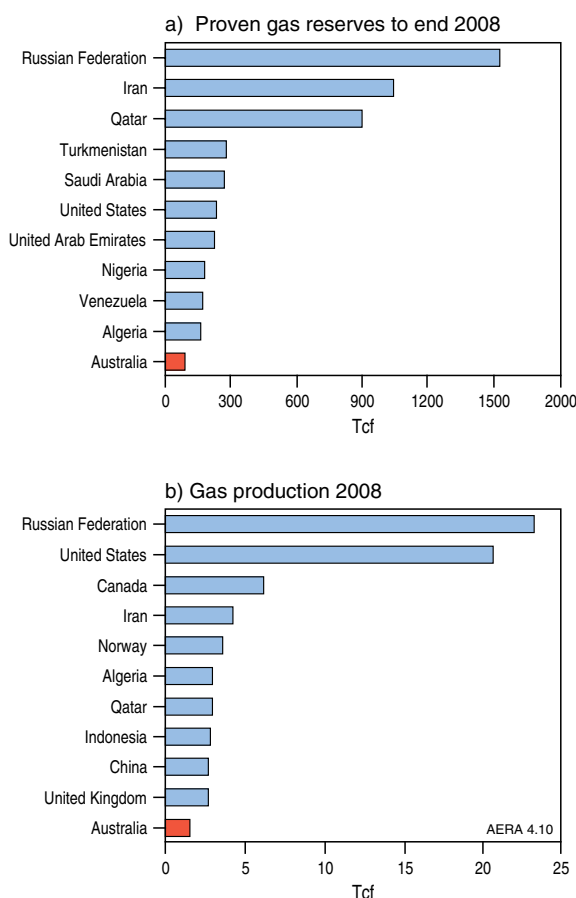
Natural gas is used all around the world (figure 4.11). The main gas consumers are the United States and the Russian Federation, followed by Iran and Japan. The Asia Pacific region accounted for around 16 per cent of world natural gas consumption in 2008, with Australia accounting for around 1.1 per cent (IEA 2009b).

Some 39 per cent of world gas consumption is for power generation, with the industry and residential sectors accounting for a further 18 per cent and 16 per cent respectively (IEA 2009b). The share of gas in total world electricity generation was 21 per cent in 2007, although this varies widely among countries

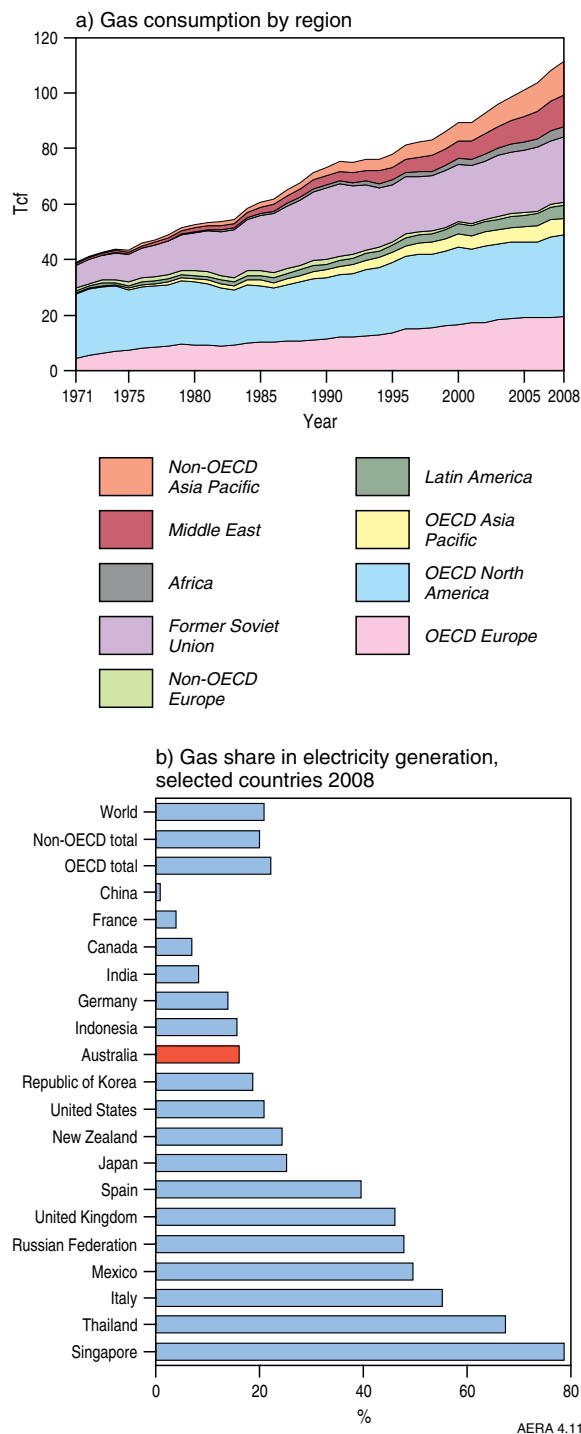
(figure 4.11; IEA 2009a). In Australia, the share of gas in total electricity generation is around 16 per cent.

**Trade**

With gas reserves located some distance from key gas consuming countries, world gas trade has increased as a proportion of total consumption. In 2008, 30 per cent of world gas consumption



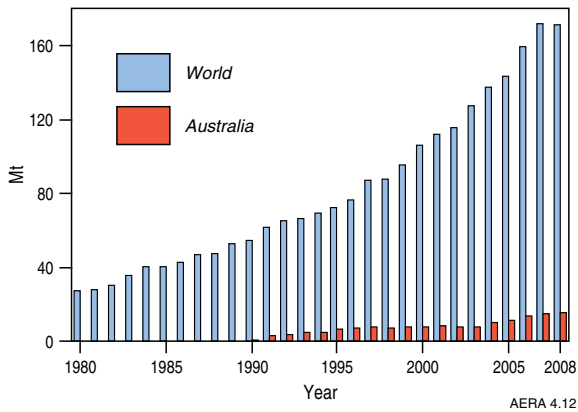
**Figure 4.10** World gas reserves and production, major countries, 2008  
**Source:** BP 2009; IEA 2009b



**Figure 4.11** World gas consumption and the share of gas in electricity generation  
**Note:** Shares in 4.11b for non-OECD and world are 2007 data  
**Source:** IEA 2009a, b



was supplied through international trade. Trade as a proportion of gas consumption is much higher in the Asia Pacific region, where countries such as Japan and the Republic of Korea are reliant on imports for much of their gas needs.



**Figure 4.12** World LNG trade

Source: BP various years

LNG imports accounted for one quarter of world gas trade in 2008, equal to 7 per cent of world gas consumption; the remainder was transported by pipeline. With fewer international pipelines in the Asia Pacific region, the share of gas trade met by LNG imports is much higher, at 83 per cent (around 31 per cent of consumption) (IEA 2009b).

World LNG trade in 2008 was 9118 PJ (168 Mt) (figure 4.12). World LNG trade is characterised by a small but increasing number of suppliers and buyers. In 2008 there were 15 countries exporting LNG and 18 countries importing LNG, with the Russian Federation and Yemen commencing exports in 2009. Qatar is the world's largest LNG exporter, with 18 per cent of world trade in 2008 (figure 4.13). Japan is the world's largest LNG importer, accounting for 41 per cent of the market. Australia is the world's sixth largest LNG exporter, accounting for 9 per cent of world LNG trade in 2008, and 13 per cent of the Asia Pacific LNG market (BP 2009).

### The role of unconventional gas

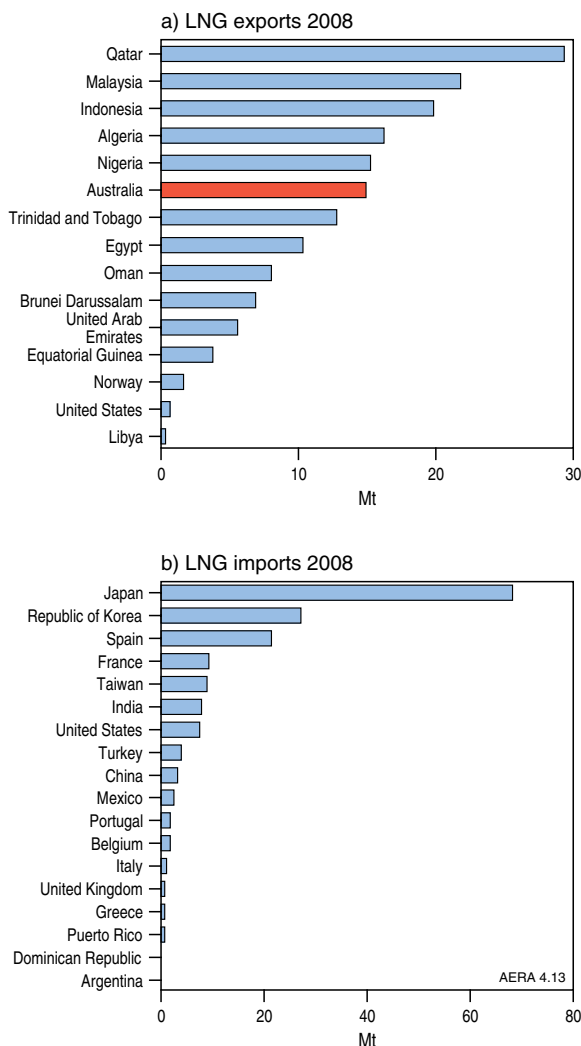
Information about global unconventional gas resources is much less complete than for conventional resources, and is less reliable. Although the resources worldwide are thought to be very large, they are currently poorly quantified and mapped (IEA 2009c).

According to the IEA, unconventional gas (including coal seam gas, shale gas and tight gas) now amounts to around 4 per cent of global proven reserves, or around 0.3 million PJ (257 tcf). World unconventional gas resources in place are much larger, estimated to be around 35.8 million PJ (32 500 tcf). Around 30 per cent of these resources are in the Asia Pacific, 25 per cent in North America, and 17 per cent in the Former Soviet Union (IEA 2009c).

Unconventional gas production accounted for 12 per cent of global gas production in 2008. Growth in unconventional gas production has been especially strong in North America. The United States accounted for three-quarters of global unconventional production with around 12 000 PJ (10.6 tcf). Unconventional production represents more than half of total US gas production. Canada was the second largest producer of unconventional gas, at nearly 2400 PJ (2.1 tcf), or around one third of its total gas output (IEA 2009c).

World coal seam gas resources in place are estimated to be around 10.2 million PJ (9047 tcf, table 4.2). The majority of these resources are in the Former Soviet Union, North America, and the Asia Pacific (IEA 2009c).

Coal seam gas is produced in more than a dozen countries, with the United States, Canada, Australia, India and China (IEA 2009c) predominating. The United States is the world's largest CSG producer, at around 2200 PJ (2.0 tcf) in 2008 (EIA 2009a). In Australia CSG production was 139 PJ (0.1 tcf) in 2008 (table 4.2).



**Figure 4.13** World LNG trade, by country, 2008

Source: BP 2009

World resources of tight gas and shale gas are also relatively large, but very uncertain, requiring further drilling and exploration to quantify. It is estimated that world tight gas resources are around 8.4 million PJ (7400 tcf, table 4.3). Around one-quarter of these are in the Asia Pacific. Other regions with significant tight gas resources include North and Latin America, the Middle East and the Former Soviet Union. Shale gas resources are estimated at around 18.2 million PJ (16 000 tcf). Similarly, large resources are in the Asia Pacific, North America, and the Former Soviet Union (IEA 2009c).

There is limited world production data for shale and tight gas. Significant quantities of tight gas are now being produced in more than ten countries. While tight gas production data in the United States and Canada are available, in other countries tight gas production is not generally reported separately from conventional sources (IEA 2009c).

The United States is the world's only large-scale producer of shale gas, producing approximately 2200 PJ (2 tcf) in 2008 (EIA 2009b). Canadian production has also risen in recent years.

Gas hydrates are widely distributed on the continental shelves and in polar regions (Makogon 2007). Sub-sea deposits have been identified in the Nankai Trough south-east of Japan, offshore eastern Republic of Korea, offshore India, offshore western Canada and offshore eastern United States. Total worldwide

resources are estimated to be between 40 and 200 million PJ (35 000 to 177 000 tcf) (Milkov 2004). Very large but unproven potential gas hydrate resources are reported from the Arctic (Scott 2009).

Currently, commercial production of gas hydrates is limited to the Messoyakha gas field in western Siberia, where gas hydrates in the overlying permafrost are contributing to the flow of gas being produced from the underlying conventional gas field (Pearce 2009). However, exploitation of gas hydrates is a rapidly evolving field. There are active research programs or experimental production in Canada, Japan, the Republic of Korea and the United States, but gas hydrates are not expected to contribute appreciably to supply in the next two decades (IEA 2009c).

The development of unconventional gas resources is most advanced in the United States and impacts on the global LNG market are already evident, including reduced demand for LNG imports into the United States. The main driver of commercial scale exploitation of unconventional resources has been the successful development and deployment of technologies that enable these resources to be produced at costs similar to those of conventional gas in these countries, particularly with recent high gas prices (IEA 2009c).

### World outlook to 2030

In its 2009 *World Energy Outlook* (IEA 2009c) reference case, the IEA projects world demand for natural gas to expand by 1.5 per cent per year between 2007 and 2030, to reach 149 092 PJ (132 tcf) in 2030 (table 4.4). The share of gas in total world primary energy demand is projected to remain at 21 per cent in 2030.

The majority of the increase in global gas use over the projection period – more than 80 per cent in total – comes from non-OECD countries, particularly in the Middle East. Demand growth is also strong in China and India (more than 5 per cent per year). In both of these countries, while the share of gas in the energy mix will remain relatively low, the volumes consumed will be significant in terms of global gas use and trade. There will be relatively low rates of demand growth in the more mature markets of North America and Europe to 2030, although they are expected to remain the largest markets in absolute terms.

The electricity sector is projected to account for 45 per cent of the increase in world gas demand to 2030, with gas fired power generation projected to increase by 2.4 per cent per year, to reach 7058 TWh (table 4.5). Low capital costs, short lead times and a relatively lower environmental impact make gas-fired power generation an attractive option, particularly where uncertainties exist on longer term low emission technology requirements.

**Table 4.2** Key coal seam gas statistics, 2008

	unit	Australia	World
CSG resources	PJ	168 600 <sup>a</sup>	10 240 000 <sup>b</sup>
	tcf	153 <sup>a</sup>	9047 <sup>b</sup>
Share of world	%	1.6	100
CSG production	PJ	139	2700 <sup>c</sup>
	tcf	0.1	2.3
Share of world	%	5.1	100
CSG share of total gas production	%	8.4	5.0

<sup>a</sup> Total identified CSG resources <sup>b</sup> Total CSG resources in place  
<sup>c</sup> Estimate includes United States, Canada and Australia only  
**Source:** IEA 2009c; EIA 2009a; Geoscience Australia

**Table 4.3** Key tight and shale gas statistics, 2008

	unit	Australia	World
Tight gas resources	PJ	22 000	8 400 000
	tcf	20	7400
Share of world	%	0.3	100
Shale gas resources	PJ	-	18 240 000
	tcf	-	16 000
Share of world	%	-	100

**Source:** IEA 2009c; Campbell 2009; Lakes Oil 2009

**Table 4.4** Outlook for primary gas demand, IEA reference scenario

	unit	2007	2030
<b>OECD</b>	PJ	52 712	60 834
	tcf	47	54
Share of total	%	23	25
Average annual growth 2007–2030	%	-	0.6
<b>Non-OECD</b>	PJ	52 502	88 258
	tcf	46	78
Share of total	%	20	20
Average annual growth 2007–2030	%	-	2.3
<b>World</b>	PJ	105 172	149 092
	tcf	93	132
Share of total	%	21	21
Average annual growth 2007–2030	%	-	1.5

Source: IEA 2009c

**Table 4.5** Outlook for gas-fired electricity generation, IEA reference scenario

	unit	2007	2030
<b>OECD</b>	TWh	2307	2962
Share of total	%	22	22
Average annual growth 2007–2030	%	-	1.1
<b>Non-OECD</b>	TWh	1819	4097
Share of total	%	20	19
Average annual growth 2007–2030	%	-	3.6
<b>World</b>	TWh	4126	7058
Share of total	%	21	21
Average annual growth 2007–2030	%	-	2.4

Source: IEA 2009c

The IEA reference case presents a business as usual outlook in the absence of any significant policy changes, such as the introduction of carbon pricing. Any eventual introduction of a carbon price would adjust the relative prices of all fuels, reflecting their different carbon intensities and, other things being equal, influencing both the level of consumer demand and the direction of supplier investment accordingly. The strength of these influences, and overall impact on gas demand, will be governed in substantial measure by market responses to the carbon price level.

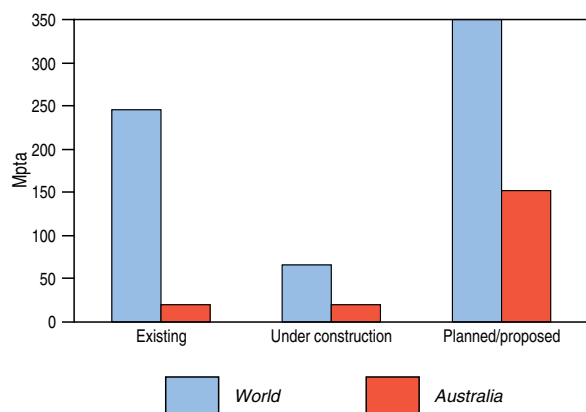
Global gas resources are sufficient to meet the projected increase in global demand, provided that the necessary investment in gas supply infrastructure is made. Production is expected to become more concentrated in the regions with large reserves, with more than one-third of the projected growth to come from the Middle East. Africa, Central Asia, Latin America and the Russian Federation are also projected to experience significant growth in production.

The share of gas produced from unconventional gas sources is projected to rise, from around 12 per cent in 2007 to nearly 15 per cent in 2030. Most of this increase is expected to come from the United States. Output is also expected to increase

in China, India, Australia and Europe, although the share of unconventional relative to conventional gas production in these regions remains small. The expected rise in unconventional gas sources has implications for prices and energy security, as well as energy trade. Increased unconventional gas production in the United States to more than half of its total gas production, for example, is reducing its reliance on imports of LNG.

Trade is expected to rise more quickly than demand (by 2.0 per cent per year over the period 2007–2030), reflecting the imbalance between the location of reserves and the sources of demand. Inter-regional gas trade is projected to rise from 27 080 PJ (24 tcf) in 2007 to 42 760 PJ (38 tcf) in 2030. Most of the increase in inter-regional gas trade is in the form of LNG, with its share of trade rising from 34 per cent in 2007 to 40 per cent in 2030. LNG trade is projected to rise by 3.7 per cent per year to 17 104 PJ (15 tcf, 314 Mt) in 2030.

Globally, more than 400 million tonnes of additional LNG capacity is either under construction, planned or proposed (figure 4.14). However, it is unlikely that many of these projects will proceed as proposed, at least in the medium term. Australia accounts for a significant share of the new capacity.



**Figure 4.14** World LNG export capacity, current and proposed

Source: ABARE

## 4.3 Australia's gas resources and market

### 4.3.1 Conventional gas resources

Australia's identified conventional natural gas is a major and growing energy resource with significant potential for further discoveries.

Australia's conventional gas resources at the beginning of 2009 are presented in Table 4.6 under the McKelvey classification of economic and sub-economic demonstrated resources (Geoscience Australia 2009). Australia has around 180 400 PJ (164 tcf) of gas, most of which are considered as EDR. These resources are located across fourteen basins, but nearly all (92 per cent) lie in the offshore basins along the north-west margin of Western Australia (figure 4.15), a geological region known as the North West Shelf (Purcell and Purcell 1988) – the Bonaparte, Browse and Carnarvon basins (table 4.7). Similarly, the bulk of this amount is in ten super-giant fields, although a total of 590 fields are included in the EDR and SDR compilation.

In addition to these demonstrated Australian conventional gas resources (EDR and SDR), another 22 000 PJ (20 tcf) are estimated to be in the inferred category, arising from recent discoveries and previous finds that require further appraisal.

Geologically these world class gas resources are related to the major delta systems that were deposited along the north-west margin during the Triassic and Jurassic periods as a prelude to Australia's separation from Gondwana. The gas is contained in Mesozoic sandstone reservoirs and largely sourced from Triassic and Jurassic coaly sediments. Marine Cretaceous shales provide the regional seal for fault block and other traps.

The offshore Gippsland Basin in south-eastern Australia still has significant reserves after 40 years

**Table 4.6** Australian conventional gas resources represented as McKelvey classification estimates as of 1 January 2009

Conventional Gas Resources	PJ	tcf
Economic Demonstrated Resources	122 100	111
Sub-economic Demonstrated Resources	58 300	53
Inferred Resources	~22 000	~20
<b>Total</b>	<b>202 400</b>	<b>184</b>

Source: Geoscience Australia 2009

**Table 4.7** McKelvey classification estimates by basin as at 1 January 2009

McKelvey Class.	Basin	Gas	
		PJ	tcf
EDR	Carnarvon	81 400	74
EDR	Browse	18 700	17
EDR	Bonaparte	11 000	10
EDR	Gippsland	7 700	7
EDR	Other	3 300	3
<b>Total EDR</b>		<b>122 100</b>	<b>111</b>
SDR	Carnarvon	22 000	20
SDR	Browse	17 600	16
SDR	Bonaparte	15 400	14
SDR	Gippsland	1 100	1
SDR	Other	2 200	2
<b>Total SDR</b>		<b>58 300</b>	<b>53</b>
<b>Total (EDR + SDR)</b>		<b>180 400</b>	<b>164</b>

Source: Geoscience Australia 2009

of production but onshore basins only account for 2 per cent of Australia's remaining resources (figure 4.15). Gas accumulations in the Gippsland, Bass and Otway basins in Bass Strait are trapped in some of Australia's youngest petroleum reservoirs (Late Cretaceous to Paleogene sandstones) while onshore are some of the oldest (Ordovician sandstones in the Amadeus Basin, Permian sandstones in the Cooper Basin). Boreham et al. (2001) provide a detailed discussion of the origin and distribution of Australia's conventional gas resources.

Development of two of the largest of the giant undeveloped fields in the basins off the northwest margin, the Ito-Ito and Gorgon fields (table 4.8), has recently been announced, with the first gas from the Gorgon project expected in 2015.

### Resource growth

Australia's identified conventional gas resources have grown substantially since the discovery of the super giant and giant gas fields along the North West Shelf in the early 1970s. Gas EDR has increased more

than fourfold over the past 30 years. Even so, many offshore gas discoveries have remained subeconomic until recently and are only now being considered for development. For example, the Ichthys field in the Browse Basin, which adds significantly to Australia's reserves of both gas and condensate (12.8 tcf, 527 mmbbls), was determined to be uneconomic when first drilled in 1980, not least because of its remote location. The big step in the gas EDR in 2008 (figure 4.16) reflects the promotion of large accumulations such as Ichthys and Wheatstone into this category.

Australia's conventional gas resources have mostly been discovered during the search for oil and have occurred continuously but at irregular intervals and include a number of super-giant fields (figure 4.17; Powell 2004). However, from the late 1990s there has been exploration aimed specifically at large gas fields in the deeper water areas of the Carnarvon Basin, which has met with considerable success, including the discovery of Ito-Ito in 2000, one of Australia's largest gas accumulations.

### Resource life

The gas resource to production ratio (R/P ratio) is a measure of the remaining years of production from current economic demonstrated resources (EDR) at current production levels. Since production was established and stabilised in the mid-1970s the EDR to production ratio has fluctuated between 20 and 80 years, boosted by the major discoveries in the 1980s and in the past 10 years (figures 4.17 and 4.18).

In 2008 at current levels of production, Australia had 63 years of conventional gas remaining.

The plot of gas discoveries by year against cumulative volume discovered shows a strong record of discovery and addition of new resources (figure 4.17).

### 4.3.2 Coal seam gas (CSG) resources

Australia's identified CSG resources have grown substantially in recent years. As at December 2008, the economic demonstrated resources of CSG in Australia were 16 590 PJ (15.1 tcf; table 4.9). In 2008, CSG accounted for about 12 per cent of the total gas EDR in Australia. Reserve life is more than

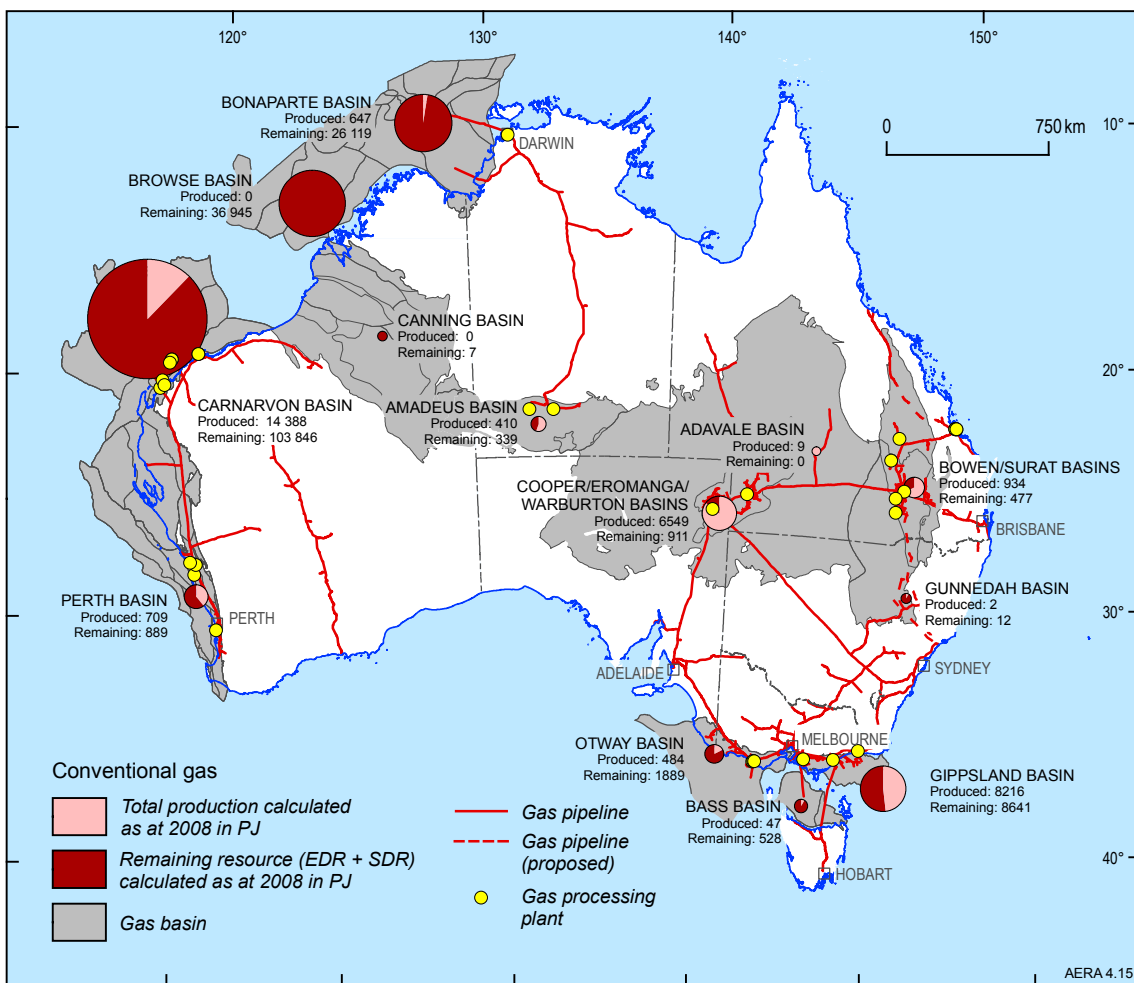


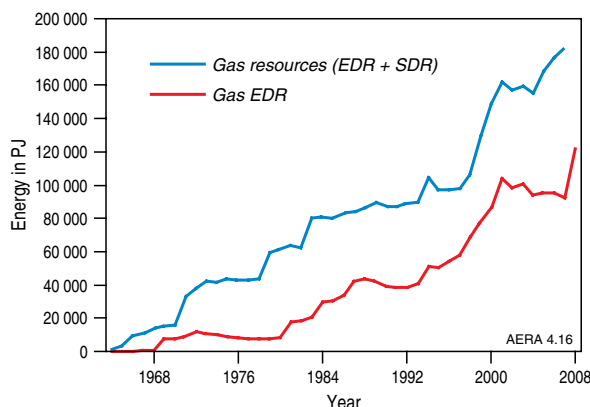
Figure 4.15 Australia's conventional gas resources, proven gas basins and gas infrastructure

Source: Geoscience Australia



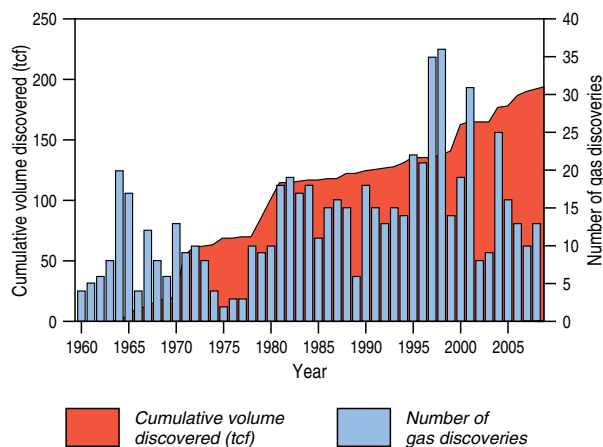
100 years at current rates of production. In addition to EDR Australia has substantial subeconomic demonstrated resources (nearly double the EDR) and very large inferred CSG resources. There are even larger estimates of in-ground potential CSG resources, potentially in excess of 250 tcf (275 000 PJ) (Baker and Slater 2009; Santos 2009).

Queensland has 15 714 PJ (or 95 per cent) of the reserves with the remaining 887 PJ in New South Wales. Nearly all current reserves are contained in the Surat (61 per cent) and Bowen (34 per cent) basins with small amounts in the Clarence-Moreton (2 per cent), Gunnedah (2 per cent), Gloucester and Sydney basins (figures 4.19 and 4.20). The CSG productive coal measures are of Permian (Bowen, Gunnedah, Sydney and Gloucester basins) and Jurassic (Walloon Coal Measures of the Surat and Clarence-Moreton



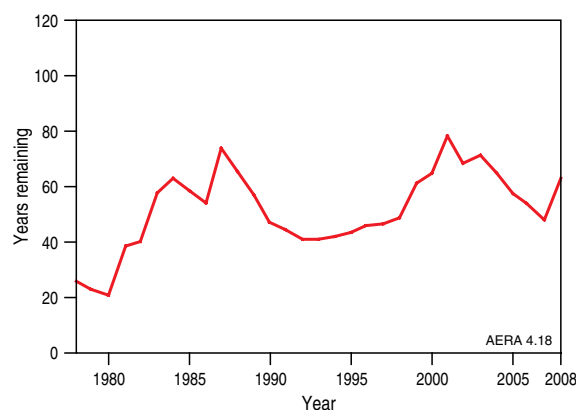
**Figure 4.16** Australia's demonstrated conventional gas resources 1964–2008

**Source:** Geoscience Australia



**Figure 4.17** Gas volumes discovered and number of discoveries by year, 1960–2008

**Source:** Geoscience Australia



**Figure 4.18** Conventional gas EDR to production in years of remaining production, 1978–2008

**Source:** Geoscience Australia

**Table 4.8** Major gas fields: development status

Field	Basin	Gas Resources tcf	Condensate Resources mmbbl	Total Resources PJ	Status
Greater Gorgon (including Gorgon, Io/Jansz, Chrysaor, Dionysus, Tryal Rocks West, Spar, Orthrus, Maenad, Geryon and Urania)	Carnarvon	>40	-	>44 000	under construction
Ichthys	Browse	12.8	527	17 137	FEED
Woodside Browse project, including Torosa, Brecknock and Calliance	Browse	14	370	17 546	undeveloped
Greater Sunrise (including Sunrise and Troubadour)	Bonaparte	7.7	-	8470	undeveloped
Evans Shoal	Bonaparte	6.6	-	7260	undeveloped
Scarborough	Carnarvon	5.2	-	5720	undeveloped
Pluto (including Xena)	Carnarvon	4.65	55.3	5436	under construction
Wheatstone	Carnarvon	4	-	4400	FEED
Clio	Carnarvon	3.5	-	3850	undeveloped
Chandon	Carnarvon	3.5	-	3850	undeveloped
Prelude (including Concerto)	Browse	2.5	40	2982	undeveloped
Thebe	Carnarvon	2 - 3	-	2200–3300	undeveloped
Crux	Browse	1.3	48	1708	under construction

**Note:** Data compiled from various public sources, including company reports to the Australian Securities Exchange

**Source:** Geoscience Australia



basins) age, although the Permian coals are of higher rank, more laterally continuous and have greater gas contents (Draper and Boreham 2006).

Over the past five years, CSG exploration has increased substantially in Queensland and New South Wales as a result of the successful development of CSG production in Queensland. The search has expanded beyond the high rank Permian coals encouraged by the success in producing CSG from low rank coals in the United States. These successes have also stimulated exploration for CSG in South Australia, Tasmania, Victoria and Western Australia.

**Table 4.9** CSG Resources at December 2008

CSG Resources	PJ	tcf
Economic Demonstrated Resources	16 590	15.1
Sub-economic Demonstrated Resources	30 000	27.2
Inferred Resources	122 020	111
<b>Total</b>	<b>168 610</b>	<b>153</b>

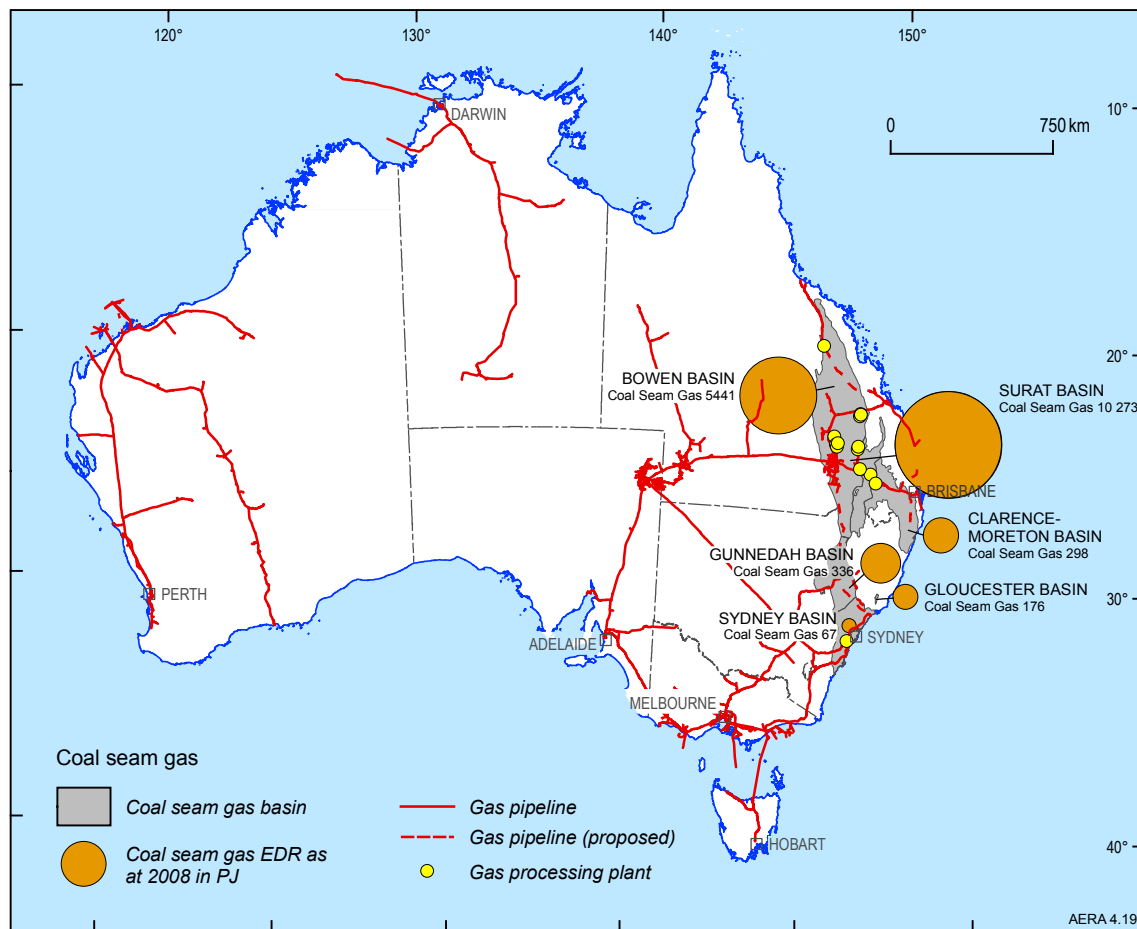
**Source:** Geoscience Australia 2009; Queensland Department of Mines and Energy 2009; subeconomic and inferred resources compiled by Geoscience Australia from company reports and other public domain information

Nonetheless, CSG exploration in Australia is still relatively immature. The current high levels of exploration are expected to add to known resources: in the five years to 2008 2P reserves increased at a rate of about 46 per cent per year, significantly increasing resource life (figures 4.21 and 4.22).

During 2007–08 CSG activity in Queensland continued at record levels with about 600 CSG production and exploration wells drilled. Exploration in Queensland continues to concentrate in the Bowen, Galilee and Surat basins while in New South Wales exploration continues in the Sydney, Gunnedah, Gloucester and Clarence-Moreton basins. All have 2P reserves. Other prospective basins include the Pedirka, Murray, Perth, Ipswich, Maryborough and Otway basins.

### 4.3.3 Tight gas, shale gas and gas hydrates resources

Currently Australia has no reserves of tight gas, but the in-place resources of tight gas are estimated at around 22 000 PJ (20 tcf). The largest known resources of tight gas are in low permeability sandstone reservoirs in the Perth, Cooper and Gippsland basins (figure 4.23). The Perth Basin is



**Figure 4.19** Location of Australia's coal seam gas reserves and gas infrastructure

**Source:** Geoscience Australia

estimated to contain about 11 000 PJ (10 tcf) of tight gas, the Cooper Basin to contain about 8800 PJ (8 tcf) (Campbell 2009) and the Gippsland Basin is considered to contain approximately 2200 PJ (2 tcf) of tight gas (Lakes Oil 2009).

Tight gas resources in these established conventional gas producing basins are located relatively close to infrastructure and are currently being considered for commercial production. Other occurrences of tight gas have been identified in more remote onshore basins and offshore. In general, Australian tight gas reservoirs are sandstones from a wide range of geological ages with low permeability due to primary lithology or later cementation.

Shale gas exploration is in its infancy in Australia, but the organic rich shales in some onshore basins have been assessed for their shale gas potential (Vu et al. 2009). Lower Paleozoic and Proterozoic shales within the Georgina and McArthur basins in the Northern Territory (figure 4.23) are likely candidates for further investigation. Cost effective horizontal drilling and hydraulic fracturing techniques are enabling unconventional gas resources to be assessed.

No definitive gas hydrates have been identified in Australian waters. The occurrence of gas hydrate was inferred from the presence of biogenic methane in sediments cored in the Timor Trough during the Deep Sea Drilling Program (DSDP 262) (McKirdy and Cook 1980) but to date none have been recovered around Australia. Bottom simulating reflectors (BSRs) that are considered as possible indicators of gas hydrates have been observed from seismic records in deep water at various locations around Australia. However, further investigations are yet to confirm the presence of gas hydrates. Anomalous pore water chemistry can also indicate gas hydrates and has been observed in several offshore Ocean Drilling Program drill cores (ODP 1127, 1129, 1131) (Swart et al. 2000) from the Eyre Terrace in the Great Australian Bight (figure 4.23).

#### 4.3.4 Total gas resources

Australia has large and growing gas resources. CSG EDR represent only a tenth of the conventional gas EDR. However, the total identified resources for CSG are significantly larger than EDR (table 4.10). The potential in-ground CSG resource is, by some industry estimates, up to three times the undiscovered volumes in the proven gas basins (table 4.10; figure 4.24). Australia's combined identified gas resources are in the order of 393 000 PJ (357 tcf), equal to around 180 years at current production rates.

The gas resource pyramid (figure 4.24) depicts these varying types of natural gas resources. A smaller volume of conventional gas and CSG identified reserves are underpinned by larger volumes of unconventional gas inferred and potential resources.

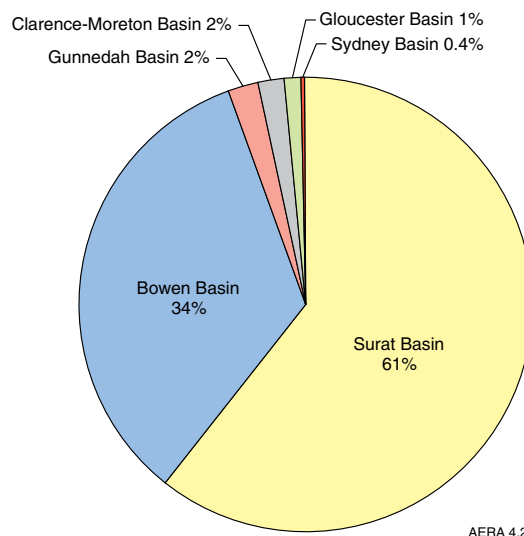


Figure 4.20 CSG EDR by basin, 2008

Source: Geoscience Australia

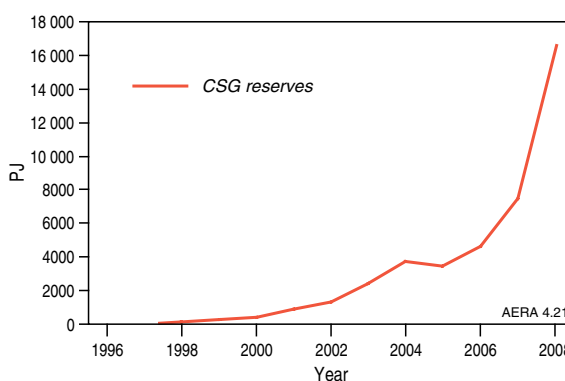


Figure 4.21 CSG 2P reserves since 1996

Source: Queensland Department of Mines and Energy 2009; Geoscience Australia

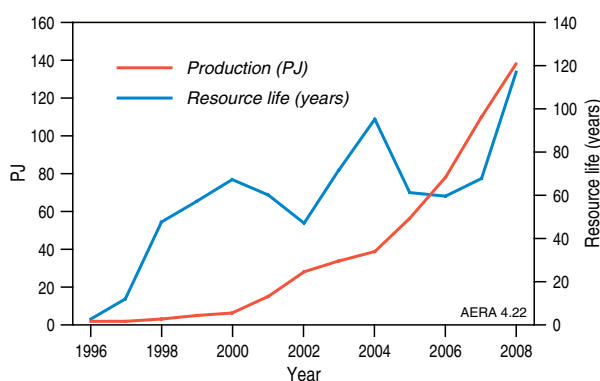
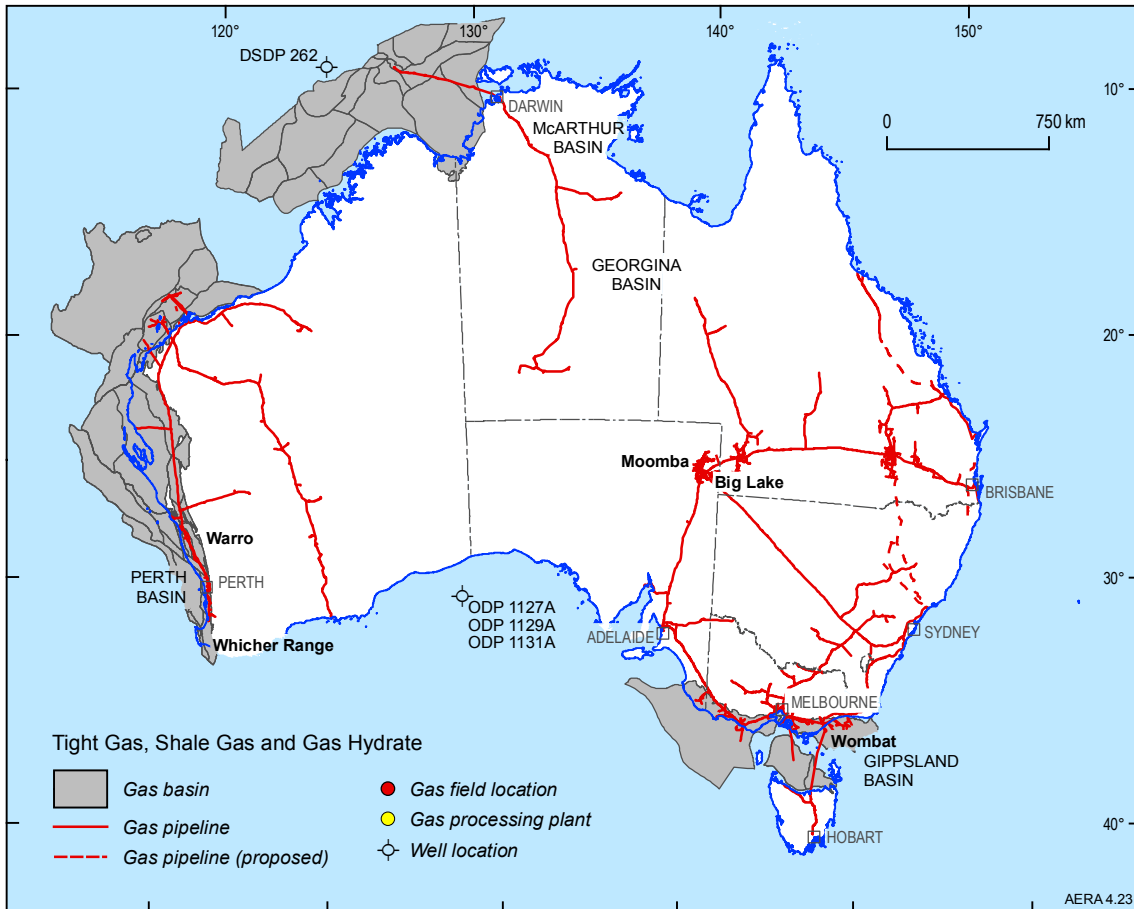


Figure 4.22 CSG resource life and production since 1996

Source: Queensland Department of Mines and Energy 2009; Geoscience Australia



**Figure 4.23** Tight gas, shale gas and gas hydrate resource locations and gas infrastructure

Source: Geoscience Australia

The estimated undiscovered conventional gas resources of varying uncertainties can also be mapped to the resource pyramid.

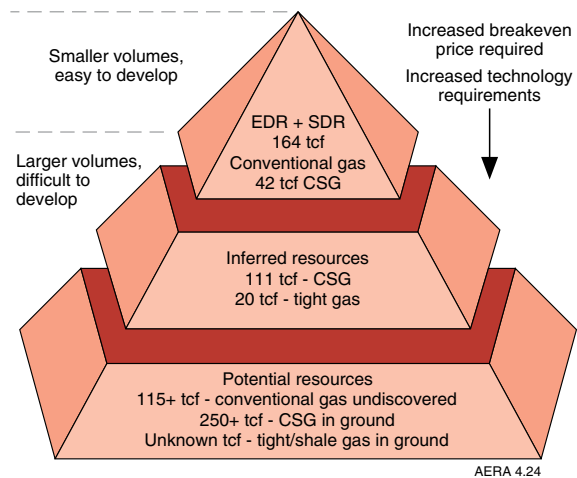
As the unconventional gas industry in Australia matures, it is expected that exploration will add to the inventory and that more of the CSG resources will move into the reserves category. CSG reserves are typically based on estimates of gas in place and a recovery factor once production has been established (Kimber and Moran 2004). Consequently the development of CSG will add to conventional gas resources to support domestic use, particularly in eastern Australia, and potentially for export.

### 4.3.5 Gas market

#### Conventional gas production

Conventional gas production has increased strongly over the last 20 years, with a major contributor being the North West Shelf LNG project in the Carnarvon Basin (figure 4.25). In 2008 conventional gas production was some 1930 PJ (1.75 tcf) and came from ten producing basins, with the Carnarvon Basin dominating (table 4.11). Next ranked is the Gippsland Basin, followed by the Bonaparte Basin.

Gas production as shown in Table 4.11 includes production from Bayu-Undan, a giant field located in the Bonaparte Basin, some 500 km north-west of Darwin in the Timor Sea Joint Petroleum Development Area (JPDA) shared by Australia and Timor Leste.



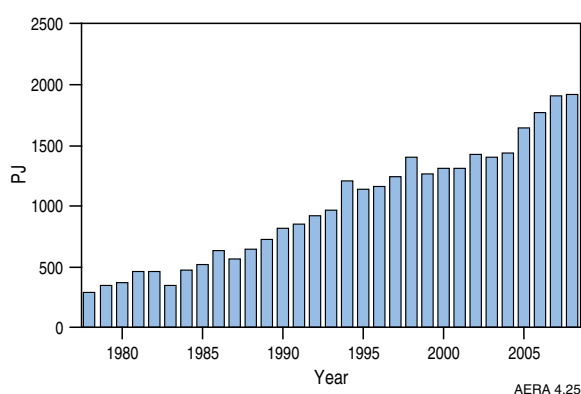
**Figure 4.24** Australian Gas Resource Pyramid (adapted from McCabe 1998 and Branan 2008)

Source: Geoscience Australia

**Table 4.10** Total Australian gas resources

Resource Category	Conventional Gas		Coal Seam Gas		Tight Gas		Total Gas	
	PJ	tcf	PJ	tcf	PJ	tcf	PJ	tcf
EDR	122 100	111	16 590	15.1	-	-	138 690	126
SDR	58 300	53	30 000	27.2	-	-	88 300	80
Inferred	22 000	20	122 020	111.0	22 000	20	166 020	151
All identified resources	202 400	184	168 600	153	22 000	20	393 000	357
Potential in ground resource	unknown	unknown	275 000	250	unknown	unknown	unknown	unknown
Undiscovered in four proven basins	125 400	114	unknown	unknown	unknown	unknown	unknown	unknown
Undiscovered frontier basins	unknown	unknown	unknown	unknown	unknown	unknown	unknown	unknown
Resources – identified, potential and undiscovered	327 800	298	443 600	403	22 000	20	793 400	721

Source: Geoscience Australia

**Figure 4.25** Australian conventional gas production 1978–2008

Source: Geoscience Australia

Geoscience Australia production and reserve data for Bayu-Undan includes all production and reserves, rather than only Australia's 10 per cent share of royalties from the JPDA (chapter 2; box 2.2).

Australia's past conventional gas production has been overwhelmingly from the Carnarvon, Cooper and Gippsland basins with smaller contributions from the Perth, Bonaparte, Bowen, Amadeus, Otway and Surat basins (table 4.11). Now that conventional gas production from the Cooper Basin is in decline, more than 80 per cent of production is from the three main offshore basins (Carnarvon, Gippsland and Bonaparte basins). Most (54 per cent) is from the Carnarvon Basin which contains the giant Goodwyn, North Rankin and Perseus accumulations that form part of the North West Shelf Venture Project. There is also production from the Perth, Bowen/Surat and Otway Basins, as well as the Amadeus Basin which

**Table 4.11** Australian conventional gas production by basin for 2008, and cumulative production

Basin	2008 PJ	Total PJ
Carnarvon	1048	14 388
Gippsland	324	8216
Bonaparte	175	647
Otway	147	484
Cooper/ Eromanga	140	6542
Bowen/Surat	41	934
Amadeus	22	410
Bass	17	47
Perth	10	709
Warburton	6	7
Gunnedah	0	2
Adavale	0	9
<b>Total</b>	<b>1930</b>	<b>32 394</b>

Note: Includes imports from JPDA

Source: Geoscience Australia

supplies Darwin with gas. Gas production from a single field in the Adavale Basin, Gilmore, ceased after 2002. Conventional gas production in all basins, other than the Carnarvon and Bonaparte basins, is directed solely to domestic consumption.

Over the past four years, new fields have been developed in the Carnarvon, Otway, Bass and Gippsland basins. In 2008, these fields produced in excess of 188 PJ accounting for 10 per cent of Australia's conventional natural gas production (table 4.12).

### Unconventional gas production

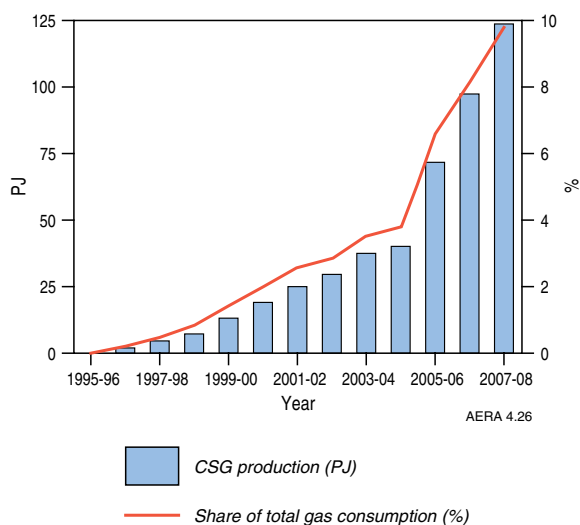
Separate commercial production of CSG is relatively new, beginning in the United States in the 1970s. Exploration for CSG in Australia began in 1976. In February 1996 the first commercial coal mine methane (CMM) operation commenced at the Moura mine in Queensland methane drainage project (then

owned by BHP Mitsui Coal Pty Ltd). In the same year, at the Appin and Tower underground mines (then owned by BHP Ltd), a CMM operation was used to fuel on-site generator sets (gas-fired power stations). The first stand-alone commercial production of CSG in Australia commenced in December 1996 at the Dawson Valley project (then owned by Conoco), adjoining the Moura coal mine.

Australia's annual CSG production has increased from 1 PJ in 1996 to 139 PJ in 2008, around 7 per cent of Australia's total gas production. In the five years to 2008 production increased by 32 per cent per year. Of the 2008 production of CSG, Queensland produced 133.2 PJ (or 96 per cent) from the Bowen (93 PJ) and Surat (40 PJ) basins. In New South Wales 5.3 PJ was produced from the Sydney Basin.

In 2007–08, CSG accounted for around 10 per cent of total gas consumption in Australia (figure 4.26) and 80 per cent in Queensland. The rapid growth of the CSG industry has been underpinned by the strong demand growth in the Eastern gas market and the recent recognition of the large size of the coal seam gas resource (table 4.13). The strong growth in CSG production reflects the Queensland Government's energy and greenhouse gas reduction policies, in particular the requirement that 13 per cent of grid connected power generation in the State be gas fired by 2005 (Baker and Slater 2009). Recent improvements in extraction technology have also supported the growth in CSG production.

Tight gas is not currently produced in Australia. However, there are several planned projects for commercial production of tight gas, notably in the Perth Basin in Western Australia. There is also no production of shale gas or from gas hydrates.



**Figure 4.26** Australian CSG production and share of total gas consumption

Source: Geoscience Australia, ABARE 2009a

### Total gas consumption

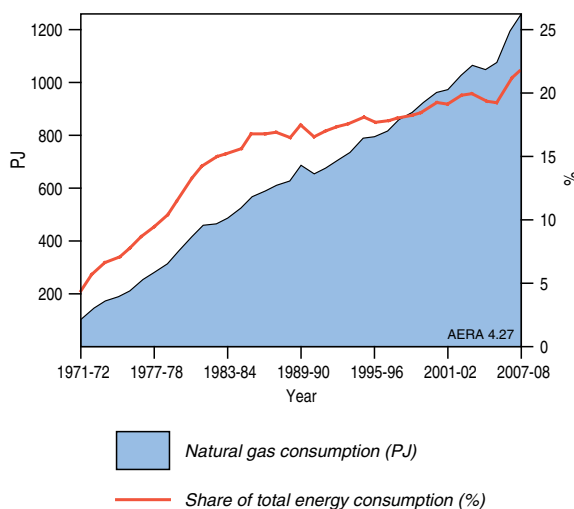
Gas is the third largest contributor to Australia's primary energy consumption after coal and oil. In 2007–08, gas accounted for 22 per cent of Australia's total energy consumption. Australia's primary gas consumption increased from 74 PJ in 1970–71 to 1249 PJ in 2007–08 – an average rate of growth of 7.9 per cent per year (figure 4.27). The robust growth in gas consumption over this period mainly reflects sustained population growth and strong economic growth, as well as its competitiveness and government policies to support its uptake.

The manufacturing, electricity generation, mining and residential sectors are the major consumers of gas. The manufacturing sector is the largest consumer of gas and is comprised of a few large consumers, including metal product industries (mainly smelting and refining activities), the chemical industry (fertilisers and plastics), and the cement industry.

The share of gas-fired electricity has increased in recent years, reflecting market reforms and an increase in gas availability. Gas accounted for an estimated 16 per cent of electricity generation in 2007–08. The strong share of the mining sector is attributable to the use of natural gas in the production of LNG. The residential sector is characterised by a large number of small scale consumers. The major residential uses of gas include water heating, space heating and cooking.

### Gas trade

Until 1989–90, Australia consumed all of the natural gas that was produced domestically. Following the development of the North West Shelf Venture, gas, in the form of LNG, was exported to overseas markets. Nearly half of Australia's gas production (currently sourced from offshore basins in Western



**Figure 4.27** Australian gas consumption and share of total primary energy consumption

Source: ABARE 2009a

Australia and the Northern Territory) is now exported. In 2007–08, the volume of LNG exports was 14.3 Mt (787 PJ), valued at \$5.9 billion. In 2008–09 higher export volumes and international oil prices led to an increase in exports to \$10.1 billion (ABARE 2009b).

Japan is Australia's major export market for LNG, followed by China, the Republic of Korea and India (figure 4.28). In 2008, Japan accounted for more than three-quarters of Australia's LNG exports. In contrast,

Australia accounts for 17 per cent of Japan's LNG total imports and 81 per cent of China's LNG imports.

There are also plans to export CSG in the form of LNG from Queensland. Increased international LNG prices together with rapidly expanding CSG reserves in Queensland have recently improved the economics of developing LNG export facilities in eastern Australia. There are at least five planned LNG projects in Queensland with a combined capacity of

**Table 4.12** Conventional gas projects recently completed, as at October 2009

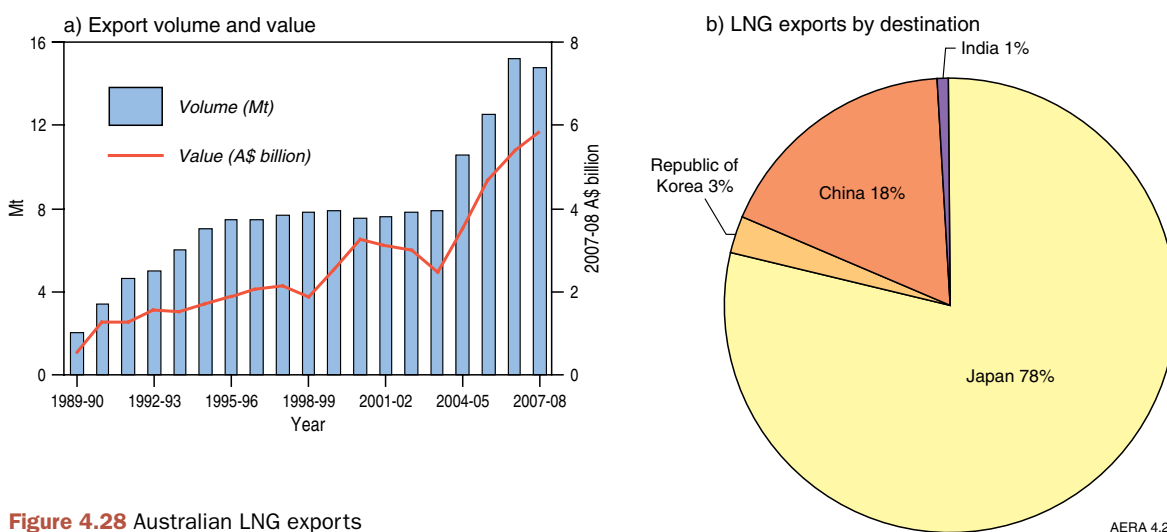
Project	Company	Basin	Start up	Capacity (PJ pa)	2008 production
John Brookes	Santos	Carnarvon	2005	58	61
Minerva	BHP Billiton	Otway	2005	55	32
Bassgas	Origin	Bass	2006	20	17
Casino	Santos	Otway	2006	33	34
Otway	Woodside	Otway	2007	60	44
Angel	Woodside	Carnarvon	2008	310	na
Blacktip	ENI Australia	Bonaparte	2009	44	na

Source: ABARE

**Table 4.13** CSG projects recently completed, as at October 2009

Project	Company	Location	Start up	Capacity (PJ pa)	Capital Expenditure
Berwyndale South CSM	Queensland Gas Company	Roma, Qld	2006	na	\$52 m
Argyle	Queensland Gas Company	Roma, Qld	2007	7.4	\$100 m
Spring Gully CSM project (phase 4)	Origin Energy	Roma, Qld	2007	15	\$114 m
Tipton West CSM project	Arrow Energy/Beach Petroleum/Australian Pipeline Trust	Dalby, Qld	2007	10	\$119 m
Darling Downs development	APLNG (Origin/ConocoPhillips)	North of Roma, Qld	2009	44 (includes wells from Tallinga)	\$500 m

Source: ABARE 2009c



**Figure 4.28** Australian LNG exports

Source: ABARE 2009b, d



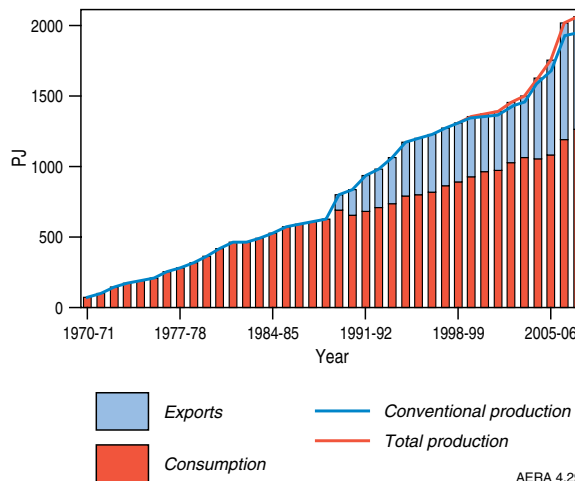
around 35 Mt, and potentially up to 57 Mt (ABARE 2009c). This is equivalent to the existing LNG production capacity and that under construction from conventional gas located off the north-west coast of Australia.

### Gas supply-demand balance

The supply-demand balance presented in figure 4.29 and table 4.14 incorporates production, domestic consumption and trade (exports). It highlights steady growth in domestic consumption, the boost in production with LNG exports and the emerging impact of CSG.

### Regional gas markets

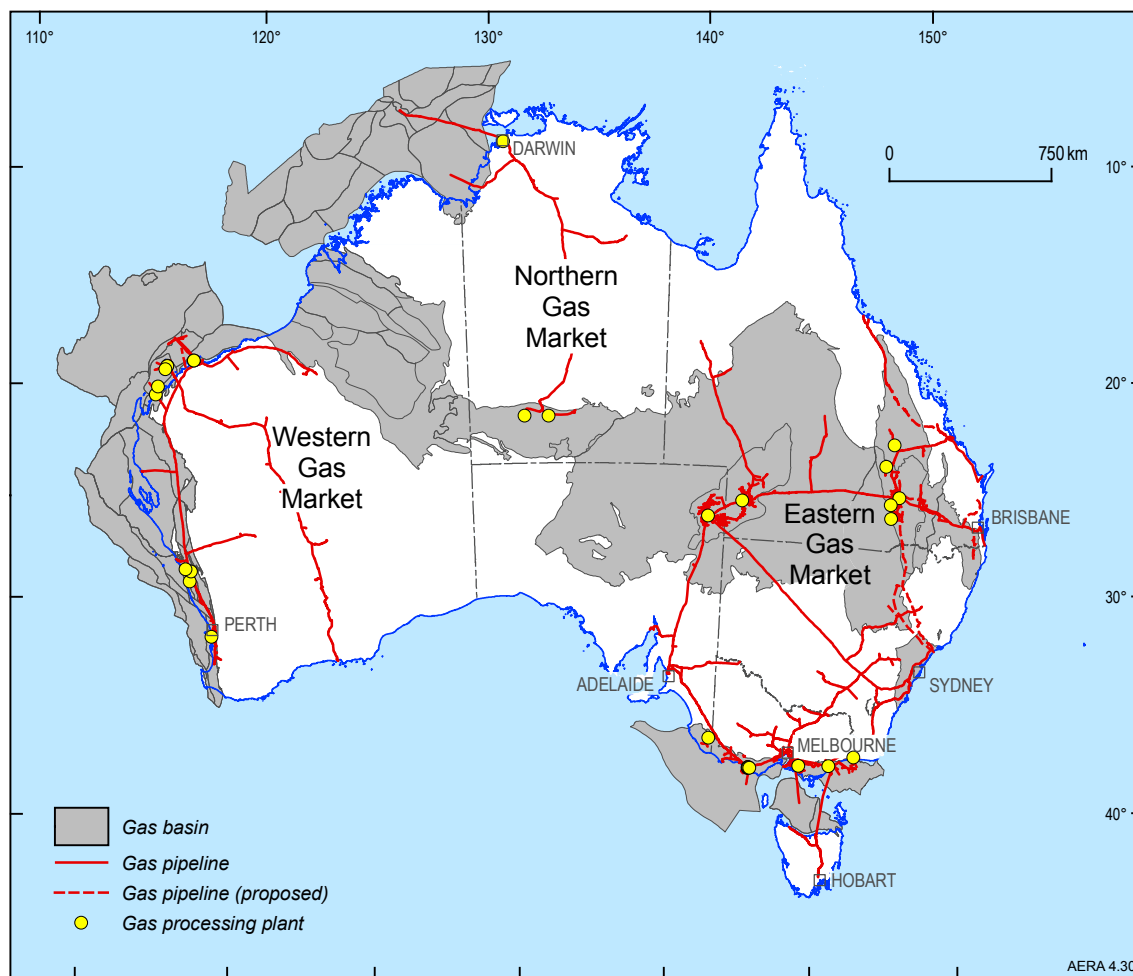
The Australian domestic gas market consists of three distinct regional markets: the Eastern market (Queensland, New South Wales, Australian Capital Territory, Victoria, South Australia and Tasmania); the Western market (Western Australia) and the Northern market (Northern Territory) (figure 4.30). These markets are geographically isolated from one another, making transmission and distribution of gas between markets uneconomic at present. As a result, all gas production is either consumed within each market or exported as LNG.



**Figure 4.29** Australia's gas supply-demand balance

**Note:** Conventional production includes imports from JPDA. Adjusted for stock changes and statistical discrepancy

**Source:** ABARE 2009a



**Figure 4.30** Australia's gas facilities

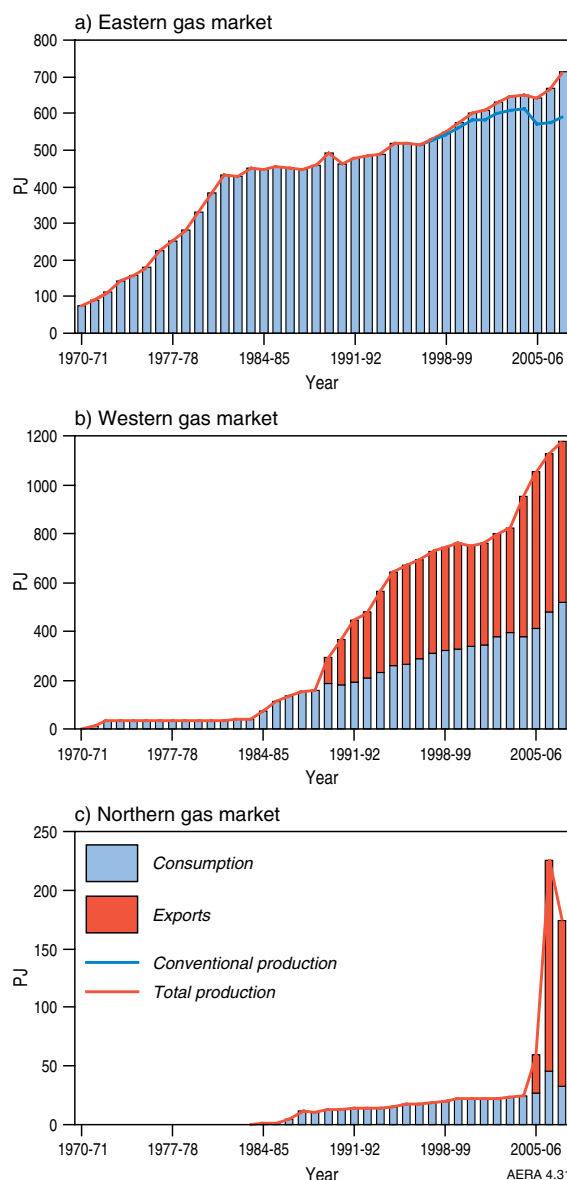
**Source:** Geoscience Australia

The Eastern gas market accounts for around 35 per cent of Australia's gas production. It is the only region where coal seam gas supplements conventional gas supplies (mainly in Queensland), accounting for nearly one fifth of total gas production in the region.

This market has traditionally been the largest consumer of natural gas in Australia, accounting for around 57 per cent of Australian gas consumption in 2007–08. Over the period 1970–71 to 2007–08, consumption in the region increased at an annual average rate of 6.3 per cent. Since 1970–71, the Eastern gas market has consumed all of the gas produced in the region (figure 4.31, panel a). The electricity generation and residential sectors are the largest consumers of gas in the Eastern market.

The Western gas market accounts for around 57 per cent of Australia's gas production. The region is also a large consumer of gas, accounting for around 41 per cent of Australia's gas consumption. The electricity generation and manufacturing sectors account for the majority of gas consumption in the Western gas market. From 1989–90, the Western gas market produced significantly more gas than it consumed (figure 4.31, panel b), following the development of the North West Shelf Venture and the establishment of long term export LNG contracts.

The Northern gas market is the smallest producer and consumer of gas in Australia, accounting for 8 per cent and 3 per cent of Australia's gas production and consumption in 2007–08, respectively. Production began in the Northern gas market in the early 1980s through the development of the onshore Amadeus Basin. In 2005–06, production in the region increased significantly with the development of the Bayu–Undan field in the offshore Bonaparte Basin. Electricity generation and mining account for the majority of gas use in the Northern gas market. Until 2005–06, all of the gas produced in the region was consumed locally.



**Figure 4.31** Regional gas market supply-demand balances

**Note:** conventional production includes imports from JPDA, stock changes and statistical discrepancy

**Source:** ABARE 2009a

**Table 4.14** Australian gas supply-demand balance, 2007–08

	Unit	Eastern gas market	Western gas market	Northern gas market <sup>a</sup>	Australia
<b>Production</b>					
Conventional gas <sup>b</sup>	PJ	589	1179	175	1942
Coal seam gas	PJ	124	0	0	124
Total	PJ	713	1179	175	2066
Share of total	%	35	57	8	100
<b>Primary gas consumption</b>					
Total	PJ	713	516	33	1262
Share of total	%	57	41	3	100
<b>LNG Exports<sup>c</sup></b>					
Total	PJ	0	663	141	804
Share of total	%	0	82	18	100

**a** Production includes imports from the JPDA in the Timor Sea. **b** Conventional production includes stock changes and statistical discrepancies.

**c** ABARE estimate

**Note:** Australian totals may not match those in Table 4.1 due to statistical discrepancies between state and national data

**Source:** ABARE 2009a

Following the development of the Darwin LNG plant, gas has also been exported as LNG (figure 4.31, panel c). In September 2009, the offshore Blacktip gas field in the Petrel Sub-basin of the Bonaparte Basin, came on stream with gas being piped onshore to a processing plant at Wadey and then to the Amadeus Basin-Darwin pipeline.

## 4.4 Outlook to 2030 for Australia's resources and market

The outlook to 2030 is expected to see the continued growth in the use of gas in the Australian energy mix and increasing LNG exports to meet growing global demand. In the latest ABARE long-term energy projections which incorporate the Renewable Energy Target, a 5 per cent emissions reduction target and other existing policies, gas is expected to increase its share of primary energy consumption to around 33 per cent (2575 PJ) in 2029–30, and account for 37 per cent of Australia's electricity generation (ABARE 2010). LNG exports are also projected to rise strongly to 5930 PJ (5 tcf) in 2029–30. Australia's existing resources are sufficient to meet these projected increases in domestic and export demand over the period to 2030. There is also scope for Australia's resources to expand further, with major new discoveries of conventional gas in offshore basins and the re-evaluation of the large CSG potential resources leading to their reclassification into the EDR category.

### 4.4.1 Key factors influencing the outlook

Broader economic, social and environmental considerations aside, the main factors impacting on the outlook for gas are prices, the geological characteristics of the resource (such as location, depth, quality), developments in technology, infrastructure issues, and local environmental considerations.

#### Gas prices

The future price of gas is one of the main factors affecting both exploration and development of the resource. Australian gas producers have typically faced different prices for domestic and export gas. Domestic prices have historically been much lower than international prices, although domestic gas prices have been rising in recent years.

For the domestic market, Australia provides some of the lowest cost gas in the world. These low gas prices are generally the result of mature long term contracts out of the Cooper and Gippsland basins and the North West Shelf fields (table 4.15).

Australian gas prices have historically been relatively stable because of provisions in long term contracts that include a defined base price that is periodically adjusted to reflect changes in an index such as the CPI. In addition, prices have been capped by the

price of coal (a major competitor for use in electricity generation).

Domestic gas prices have increased over the past few years in response to a number of factors including:

- sustained pressure on exploration and development costs, that have increased the cost of development;
- the development of higher cost sources of gas (for example coal seam gas);
- the anticipated implementation of an emissions reduction target that will make gas a more valuable commodity (there is some evidence that this is being factored into contracts);
- strong coal prices that have been increasing rapidly (and remain high historically despite the drop in late 2008 and early 2009) and raising the cap on gas prices; and
- high oil prices that have flowed through to Australian LNG contracts and accentuated the gap between domestic and international (netback) prices. This has encouraged companies to put their efforts into developing projects destined for export rather than domestic demand.

Except for Victoria, there is currently no formal exchange for trading natural gas in Australia. In all jurisdictions except Victoria, wholesale gas trading occurs through private negotiations between buyers and sellers. The terms, quantities and prices are confidential and can vary significantly across contracts. Typically these contracts contain take-or-pay components where shippers agree to pay for a specified quantity of gas, regardless of whether they are able to on-sell it.

LNG contracts generally have a price component linked to world energy prices (typically crude oil) and also include the cost of processing and transport. Typically, LNG must travel large distances to markets. LNG transport costs are distance and time sensitive and, as such, can account for a significant proportion of overall LNG costs.

There have been three reasonably distinct markets for LNG, each with its own pricing structure. In the United States, pipeline natural gas prices have been used as the basis for setting the price of LNG. The benchmark price is either a specified market in long-term contracts or the Henry Hub price for short-term sales. In Europe, LNG prices are related to competing fuel prices, such as low-sulphur residual fuel oil, although LNG is now starting to be linked to natural gas spot and futures market prices. In the Asia Pacific region, Japanese crude oil prices have historically been used as the basis for setting the price of LNG under long term contracts. Asian prices are generally higher than prices elsewhere in the world. While still distinct, the markets are becoming

more interconnected, not least because of the rapid growth in Middle East LNG supply to both regions (IEA 2008).

Over the long term, LNG prices are assumed to follow a similar trajectory to oil prices, reflecting an assumed continuation of the established relationship between oil prices and long-term LNG supply contracts through indexation, and substitution possibilities in electricity generation and end use sectors (ABARE 2010). In its 2009 World Energy Outlook, the IEA flags a potential relaxation of this relationship as significant new gas supplies come on line, thus placing some downward pressure on prices. However, indexation will still remain dominant in the Asia Pacific region, where most of Australia's gas trade will continue to occur (IEA 2009c).

At the domestic level, the Australian Energy Regulator also points to a number of factors in the east coast market that may reduce upward pressure on gas prices (AER 2009). These include the substantial volumes of 'ramp up' gas that are likely to be produced in the lead-up to the commissioning of CSG-LNG projects, the large number of gas basins ensuring diversity of supply, relatively low barriers to entry, and an extensive gas transmission network linking producing basins (ABARE 2010).

### Resource characteristics

The decision to develop a gas field also depends on its characteristics. They include its size, location and distance from markets and infrastructure; its depth (in the case of offshore fields); and the quality of the gas, such as CO<sub>2</sub> content and presence of natural gas liquids. Table 4.16 lists these characteristics for a number of Australian conventional gas fields.

Resource characteristics influencing the development of unconventional gas resources partly diverge from those relevant to conventional gas fields. Location and size of accumulation remain important but there are no associated hydrocarbon liquids with CSG. As all current identified unconventional resources in Australia are onshore, distance to market and infrastructure are key location factors.

The geological factors which influence CSG resource quality include tectonic and structural setting, depositional environment, coal rank and gas generation, gas content, permeability and

### BOX 4.3 GEOLOGY OF AUSTRALIA'S MAJOR CONVENTIONAL GAS FIELDS

Australia's identified and potential gas resources occur within a large number of sedimentary basins (Boreham et al. 2001) that stretch across the continent and its vast marine jurisdiction. Identified conventional gas resources are predominantly located in offshore basins along the north-west margin. Much of the undeveloped resource and the undiscovered potential is in deep water (figures 4.32 and 4.33; see discussion below). The gas habitat includes:

- large fault block traps, Triassic to Jurassic sandstone reservoirs sealed by Cretaceous shales and sourced from Triassic coaly sediments (e.g. North Rankin, Gorgon);
- drape anticlines and structural/stratigraphic traps related to Late Jurassic and Early Cretaceous sand bodies (e.g. Io-Jansz, Scarborough; figure 4.32); and
- low relief anticlines with Permian sandstone reservoirs (e.g. Petrel; figure 4.33).

In the Bass Strait basins (Otway, Bass and Gippsland) along the south-east margin, conventional gas accumulations are contained in Late Cretaceous to Paleogene sandstone reservoirs in anticlinal, fault block and structural/stratigraphic traps. In addition there are known gas resources in a number of onshore basins usually in Paleozoic sandstone reservoirs in structural traps.

hydrogeology. Draper and Boreham (2006) concluded that, for Queensland GSG, neither rank nor gas content was critical, but rather permeability and hence deliverability, with structural setting being a strong determinant of permeability. For shale gas, resource quality is dependent on gas yield which is controlled by organic matter content, maturity and permeability, particularly that provided by natural fracture networks. Reservoir performance (porosity and permeability) is the primary determinant of the quality of all gas resources and the point of difference between conventional gas and tight gas.

**Table 4.15** Australian gas prices (2008–09 dollars)

	2001–02	2002–03	2003–04	2004–05	2005–06	2006–07	2007–08	2008–09
Natural Gas <sup>a</sup> \$A/GJ	\$2.16	\$2.34	\$2.50	\$2.59	\$2.71	\$3.34	\$3.72	\$3.32
LNG <sup>b</sup> \$A/t	\$428.17	\$402.49	\$324.32	\$348.10	\$401.94	\$376.29	\$428.63	\$620.71
LNG <sup>b</sup> \$A/GJ	\$7.87	\$7.40	\$5.96	\$6.40	\$7.39	\$6.92	\$7.88	\$11.41

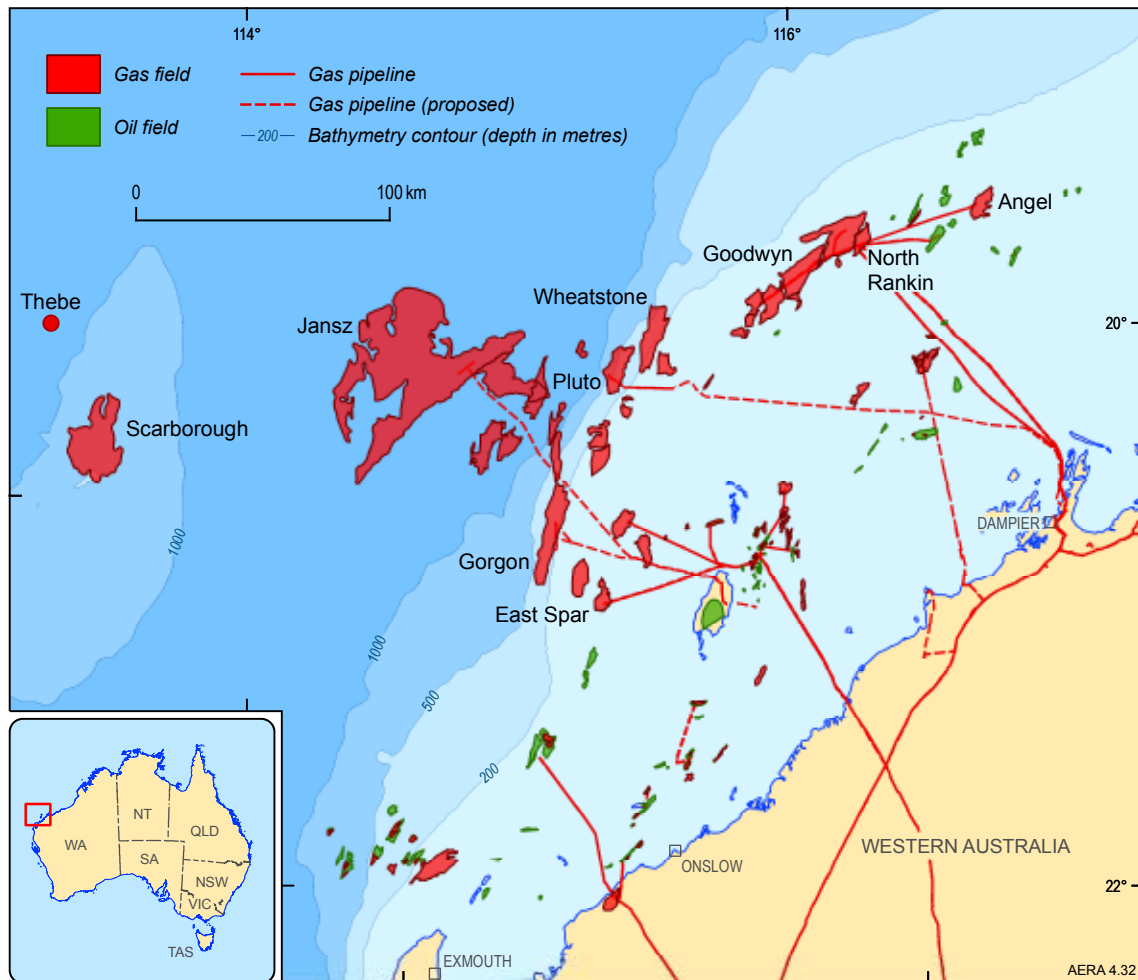
<sup>a</sup> Financial year average of daily spot prices in the Victorian gas market. <sup>b</sup> Export unit value

Sources: ABARE 2009d; AEMO 2009a

**Table 4.16** Resource characteristics of selected Australian conventional gas fields

Basin/ discovery date	Field	initial recoverable volumes			CO <sub>2</sub> %	water depth m	km to landfall	status
		gas tcf	liquids mmbbl	Total PJ				
<b>Carnarvon</b>								
1971	North Rankin	12.28	203	~ 14 700	< 5%	122	130	export LNG 1989
1980	Gorgon	17.2	121	~ 19 630	> 10%	259	120	construction, LNG 2015
1980	Scarborough	5.2	0	~ 5 720	< 5%	923	310	undeveloped
2006	Pluto	4.6	0	~ 5 060	< 5%	900	190	construction, LNG 2011
1993	East Spar	0.25	14	~ 360	< 5%	98	100	domestic production 1996
<b>Browse</b>								
1980	Ichthys	12.8	527	~ 17 180	> 5%	256	220	FEED, LNG 2015
1971	Torosa	11.4	121	~ 13 250	> 5%	50	280	undeveloped

**Note:** Data compiled from various public sources, including companies' reports to the Australian Securities Exchange  
**Source:** Geoscience Australia



**Figure 4.32** Gas fields in the Carnarvon Basin

**Source:** Field outlines are provided by GPInfo, an Encom Petroleum Information Pty Ltd product. Field outlines in GPInfo are sourced, where possible, from the operators of the fields only. Outlines are updated at irregular intervals but with at least one major update per year



### Location and depth

The location of the gas, onshore or offshore, in shallow or deep water, also affects development costs. Offshore development generally has higher cost and risk than conventional onshore development because of the specialised equipment required for exploration, development and production.

The Australian gas industry has moved from the development of fields in shallow water (Gippsland Basin) and near shore (Carnarvon Basin) that have a low marginal cost to fields in deeper water that have higher marginal costs.

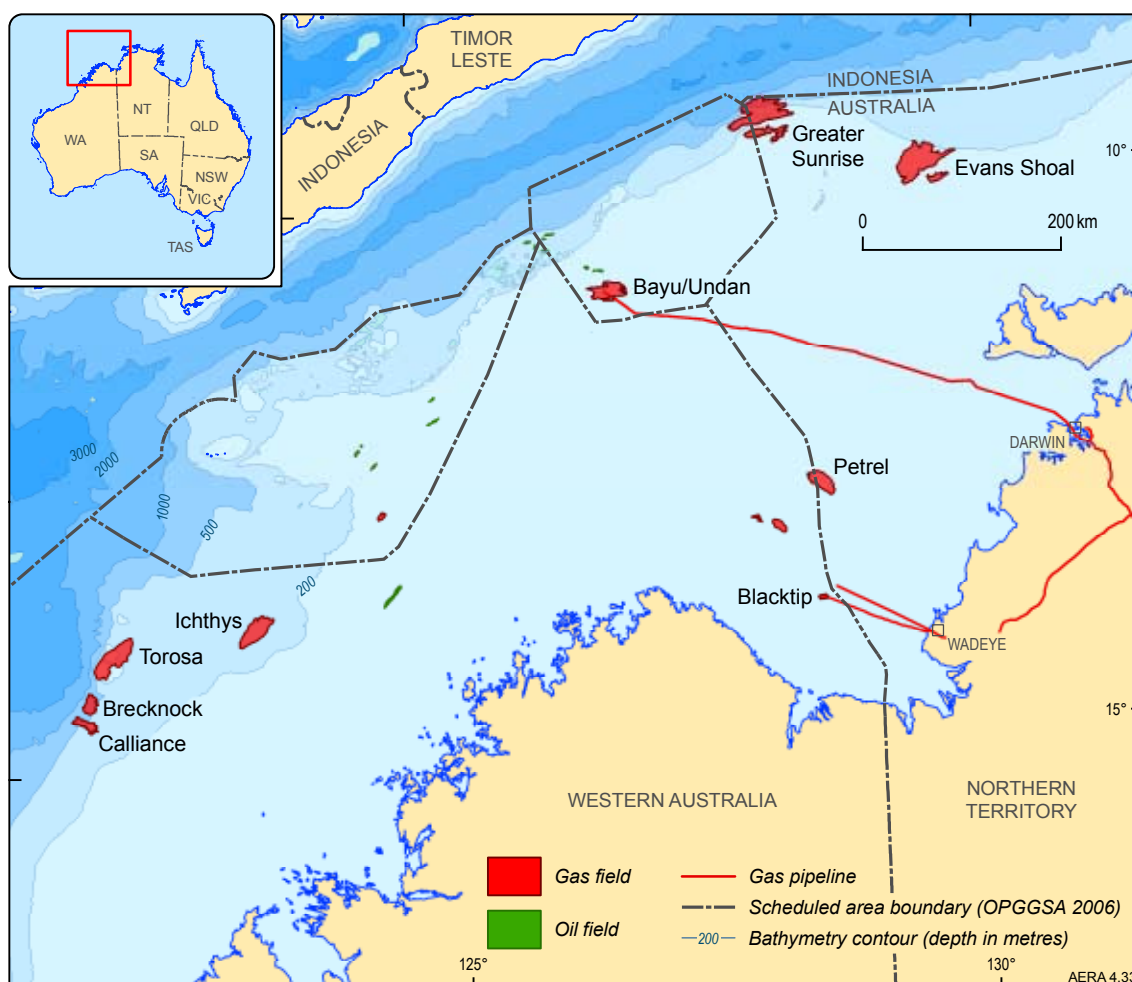
In the Carnarvon Basin, the Goodwyn gas field in 125 m of water is currently Australia's deepest producing gas field, although Ichthys, Pluto and some fields linked into the Greater Gorgon Project will be in water depths of several hundred metres or more (figure 4.32; table 4.16) and gas exploration on the Exmouth Plateau now routinely targets prospects in water depths beyond 1000 m (Walker

2007). These projects have higher technological and economic risks and costs compared with onshore developments (Hogan et al. 1996). A number of large gas accumulations in deep water remain to be developed (for example Scarborough) whereas smaller accumulations in shallower water have been developed (figure 4.32).

Although the new CSG and the embryonic tight gas industries in Australia are onshore activities, they carry technological risks comparable to deepwater conventional gas developments. The Whicher Range tight gas field discovered in 1969 in the onshore southern Perth Basin, for example, has a history of unsuccessful attempts using the then latest drilling technology to commercially produce a multi-tcf in-ground resource (Frith 2004).

### Co-location with other resources

A resource that contains only gas can be left undeveloped until market conditions warrant its development. However, gas rich in condensate or



**Figure 4.33** Gas fields in Browse and Bonaparte Basins

**Source:** Field outlines are provided by GPinfo, an Encom Petroleum Information Pty Ltd product. Field outlines in GPinfo are sourced, where possible, from the operators of the fields only. Outlines are updated at irregular intervals but with at least one major update per year. Field outline for Ichthys is sourced from IHS Energy, 2006



associated with oil, will become available when the liquid resource is produced, and must be sold (piped), flared or reinjected to maintain reservoir pressure. Depending on the nature of the reservoir, up to 80 per cent of reinjected gas can be recovered once oil production or condensate stripping has ceased (Banks 2000). Around 94 per cent of operating fields producing gas in Australia also produce oil or condensate or both. When oil, gas, LPG and condensate are produced jointly, the cost of production is shared and the cost of each product is not distinguishable. This can result in greater returns on the sale of valuable by-products and can speed development of the gas accumulation, as for example at the East Spar and Bayu-Undan projects (table 4.16).

CSG is almost entirely methane and unlike many conventional gas fields has no associated petroleum liquids. However, CSG is associated with groundwater, and coal formations have to be de-watered to lower the pressure before the coal seam gas can be produced. This can involve the production of large volumes of saline water to be disposed of (for example by deep re-injection in the sub-surface) or treated (for example by de-salination). In 2006–07 Queensland CSG fields produced 85 PJ of gas but also 9491 million litres (ML) of water, roughly 110 ML for each petajoule of gas (Green and Randall 2008). Scaling up for LNG production may produce up to 40 ML a day from a LNG project. In some cases water resources for industrial and agriculture uses or environmental flows are produced, for example, the Spring Gully Reverse Osmosis Water Treatment Plant which has a capacity of 9 ML a day (Origin Energy 2009).

Gas, both conventional and unconventional, can partner with intermittent renewable energy sources to maintain a sustained power output. Analysis of solar, wind and wave energy potential around Australia suggest the North Perth and Otway basins as areas where identified gas resources and high wind and wave potential energy occur relatively close to existing pipeline and electricity grid infrastructure and to domestic markets. This linkage between gas-fired electricity and wind generation via the transmission network has been identified in various projections such as the Vision 2030 by Vencorp in 2005 and the recent AEMO update (AEMO 2009b).

### Technology developments

Advances in technology can increase access to reservoirs, increase recovery rates, reduce exploration, development and production costs, and reduce technological and economic risks.

Technological improvement has had a significant influence on exploration activity by increasing the accessibility of resources. In the period 1989–1998, for example, technological advances (mainly 3D seismic) were the principal driver of new discoveries and rising success rates in offshore Australian exploration (Bradshaw et al. 1999) and continue to

yield gains especially in the basins along the north-west margin (Longley et al. 2002; Williamson and Kroh 2007).

Offshore gas production is more challenging than onshore production. The majority of Australia's conventional gas resources are located offshore and consequently the majority of research and development has been directed toward improving offshore technologies. New drilling technologies used in the production phase allow better penetration rates even in very deep water (beyond 3000 m), with lower costs and higher efficiency. Such technologies include multi-lateral drilling (multiple well bores from a single master well), extended reach drilling (up to 11 000 m) and horizontal drilling with paths through the reservoir of up to 2 km.

Sub-sea production facilities instead of above-water platforms are lower cost developments which also reduce weather and environmental risk. Significant development of sub-sea technologies for the transport of natural gas include deepwater pipeline installation through the J-lay method (as distinct from the S-lay method traditionally used for up to 2500 m depth). This allows pipelines to be laid up to several kilometres in depth (IEA 2008).

There have also been improvements to LNG technologies over time to improve efficiency and reduce costs, including increasing LNG train size and developing more suitable liquefaction methods to suit gas specifications. Innovations such as floating LNG facilities are also being explored. They would have a fundamental impact on the industry by commercialising relatively small and previously stranded gas resources (Costain 2009; see box 4.4 for more details).

Gas-to-liquids (GTL) provides another option for bringing gas to markets. It allows for the production of a liquid fuel (petrol or diesel products) from natural gas which can be transported in normal tankers like oil products. GTL is a potential solution to stranded gas reserves too remote or small to justify the construction of an LNG plant or pipeline. However, the commercial viability of GTL projects has not yet been widely established. There are currently only three commercial-scale plants in operation, in South Africa, Malaysia and Qatar. Two more plants are under construction in Qatar and in the Niger Delta, scheduled to commence operations in 2010 and 2012 respectively (IEA 2009c). A GTL demonstration plant that directly uses natural gas containing CO<sub>2</sub> as a feedstock was recently opened in Japan (Nippon GTL 2009). This technology may be applicable to some of Australia's gas fields.

Recent advances in gas-fired electricity generation technology have improved the competitiveness of gas compared with coal. Open cycle (or simple cycle) gas combustion turbine is the most widely used, as it is

ideal for peaking generation. Significant efficiency gains have been recognised with the natural gas combined-cycle (NGCC) electricity generation plant, which currently has world's best practice thermal efficiencies (box 4.5).

### Cost competitiveness

Brownfields projects, which are an expansion of an existing project, tend to be more attractive on both capital and operating cost grounds than new projects (often referred to as greenfield projects). This is because existing infrastructure and project designs can be used, among other reasons. For example, the fourth and fifth trains in the North West Shelf Venture have significantly lower unit costs than the greenfield Pluto and Gorgon developments currently under construction (table 4.17).

The cost of new developments has increased rapidly, with the average cost worldwide more than doubling between 2004 to 2008. Over the same period, development costs in Australia have also increased (APPEA 2009b) and are likely to increase further as a result of development of projects in deeper water that are typically more expensive than onshore and shallow water projects.

The capital costs of LNG liquefaction plants fell from approximately US\$600 per tonne per year of installed

capacity in the 1980s to US\$200 in the 1990s, but in 2008 rose to around US\$1000 or more for some new plants. It must be borne in mind, however, that unit costs are highly dependent on site-specific factors. A tight engineering and construction market has contributed to recent delays in LNG projects as well as cost increases. Material costs have increased sharply, particularly for steel, cement and other raw materials. Limited human resources – in terms both of the number of capable engineering companies and of engineers, as well as skilled labour for construction – have also been a factor (IEA 2008).

Generally, CSG can be produced using similar technologies to those used for the development of conventional gas. Compared with the conventional gas, CSG projects can generally be developed at a lower capital cost because the reserves are typically located at a shallow depth and hence require smaller drilling rigs. The production of CSG can also be increased incrementally given the shallow production wells. Although hundreds of wells are needed to produce a field as opposed to a few dozen at most in a giant conventional gas field, they are hundreds of metres rather than kilometres deep, and take a few days as opposed to weeks to drill (box 4.6). Nonetheless, they have their own particular engineering requirements.

### BOX 4.4 DEVELOPMENTS IN LNG TECHNOLOGIES

Technological developments have focussed on optimising train size, choice of compressor drivers, and the suitability of different liquefaction technologies to certain gas qualities.

LNG trains have been increasing in size (figure 4.34), leading to economies of scale which, until relatively recently, contributed to a decline in unit costs for LNG projects. Trains of up to 8 Mt per year, often referred to as mega-trains, are being constructed in Qatar.

Smaller scale trains are now also being explored. Smaller scale export plants of 1–2 Mt per year, which were common in the early days of LNG in the 1960s and 1970s, were not constructed in the 1980s and 1990s, as liquefaction technology advanced and train size grew to reduce unit investment costs. Potential advantages of smaller trains include smaller feedgas and market requirements, smaller capital expenditure and potentially quicker decision-making and implementation. While smaller projects would not benefit from scale economies, which may result in a higher unit cost of gas, they may allow other companies to enter the LNG market (IEA 2008). Smaller LNG export projects that have emerged in Australia include some of the coal seam gas based proposed projects in Queensland.

Some offshore LNG liquefaction projects are also being planned for developing relatively small and stranded gas resources. These include the concept of liquefaction plants onboard LNG tankers, and floating production and storage operations. This could be particularly advantageous for developing offshore stranded gas deposits where the size of the reserve and the distance to shore does not justify a pipeline connection to an onshore liquefaction plant (IEA 2008). This prospect is currently being considered by several project proponents in Australia, including the proposed Prelude, Bonaparte and Sunrise projects (ABARE 2009c).

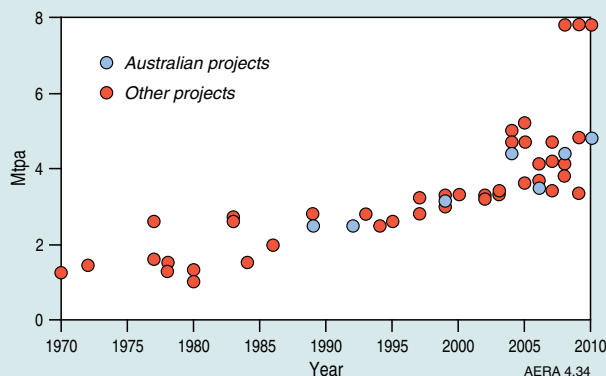


Figure 4.34 Annual liquefaction capacity of LNG trains

Source: ABARE

In some cases coal seam geology makes it difficult to extract gas, and advanced techniques are required to enhance well productivity. Moreover, the water contained in the coal seam needs to be removed before gas can be extracted. These difficulties associated with the development of CSG need to be carefully managed to avoid increased costs. In the Australian context, wide diameter holes with pre-slotted casing and under-reamed coal intervals have been found to improve CSG well performance.

### Development timeframe

The time taken to bring a resource to market affects the economics of a project. Typically, developing gas fields for the domestic market takes less time than

LNG export projects. The size of a project is also likely to affect the time that it takes to come online. Almost 70 per cent of all projects currently producing gas in Australia were completed within ten years of initial discovery (figure 4.36). On average, gas projects took around eight and a half years to bring into production.

On the other hand, LNG projects in Australia and worldwide often have a significant lag between first announcement, final investment decision, and development, as proponents undertake various studies to determine project feasibility, its design and its market prospects (seeking to secure long term markets) before construction commences.

**Table 4.17** Australian LNG projects, capital costs and unit costs

Project	State	Year completed	Capital cost A\$b	Capacity Mt	Unit cost \$/t
North West Shelf 4th train	WA	2004	2.5	4.4	57
Darwin LNG	NT	2006	3.3	3.2	103
North West Shelf 5th train	WA	2008	2.6	4.4	59
Pluto LNG	WA	late 2010	12.0	4.3	279
Gorgon LNG	WA	2015	43.0	15.0	287

Source: ABARE

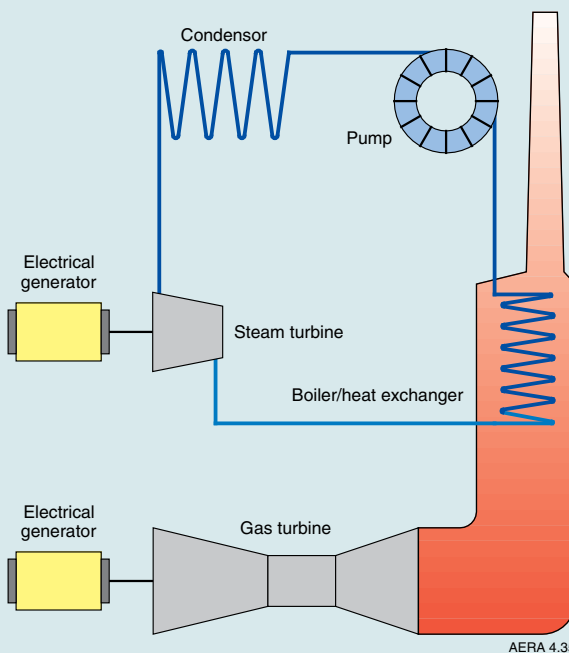
### BOX 4.5 NATURAL GAS COMBINED CYCLE POWER PLANTS

This technology is based on generating electricity by combining natural gas fired turbines and steam turbine technologies. It uses two thermodynamic cycles — the Brayton and Rankine cycles. Electricity is first generated in open cycle gas turbines (Brayton Cycle) by burning the gas and the exhaust heat is then used to make steam to generate additional electricity using a steam turbine (Rankine Cycle). This is shown schematically in figure 4.35.

NGCC technology provides plant efficiencies of up to 50 per cent. Other advantages of NGCC plants are reduced emissions, high operating availability factors, relatively short installation times, lower water consumption, and flexibility in despatch. The size of combined cycle turbines has increased as the technology has matured; units up to 1000 MW capacity are now available.

As of 2009 there were 12 gas-fired combined cycle power plants operating in Australia with a combined capacity around 3 GW and a further four under construction with a combined capacity of around 2 GW. Three of the largest of the gas-fired combined cycle power plants are the 435 MW NGCC plant at Tallawarra near Wollongong, commissioned in March 2009, the 1000 MW Mortlake gas-fired power station in Victoria due for commissioning in 2010 and the 630 MW Darling Downs gas-fired power station at Braemar near Dalby due to be commissioned in early 2010. The Darling Downs plant will be fuelled by coal

seam gas from reserves near Roma and Chinchilla. A proposed 550 MW combined cycle gas-fired power station at Morwell in Victoria will use a combination of natural gas and syngas produced from drying and gasification of brown coal from the Latrobe Valley.



**Figure 4.35** Schematic picture of combined cycle gas turbine

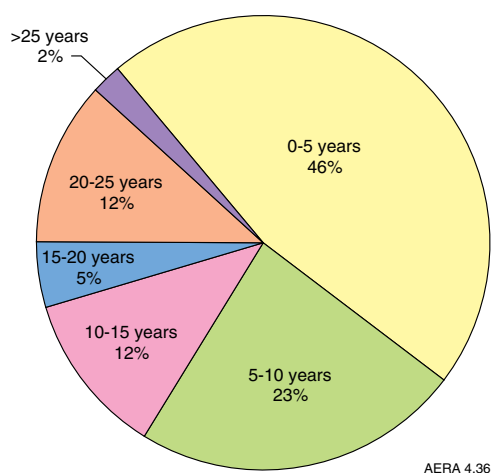
Source: Wikimedia ([http://en.wikipedia.org/wiki/Combined\\_cycle\\_gas\\_turbine](http://en.wikipedia.org/wiki/Combined_cycle_gas_turbine))

Construction alone can take at least three years, and often longer. The Darwin LNG project, for example, took 32 months from notice of construction in June 2003 to the first delivery of LNG in February 2006. The larger Pluto project is anticipated to take five years (table 4.18) and will be the fastest LNG project (from discovery to production) to be developed in Australia and one of the fastest by world standards.

### Transmission and distribution infrastructure

The last two decades have seen large investments in transmission pipelines and distribution networks to meet the steady growth in domestic gas demand. Before the 1990s Australia's transmission pipelines were a series of individual pipelines, each supplying a demand centre from a specific gas field. The majority were government owned and there was little interconnection. Since the early 1990s Australia's transmission pipeline network has almost trebled in length (AER 2008); and the eastern states have become interconnected, with Adelaide, Canberra, Melbourne and Sydney each now being supplied by two separate pipelines. Since 2000 more than \$4 billion has been invested in new pipelines and the expansion of pipeline capacity with major investments including the Eastern Gas Pipeline, the SEA Gas Pipeline and expansion of the Dampier to Bunbury Pipeline (AER 2009).

This level of investment looks set to continue in the short term with a further \$1.8 billion of investment, in various stages of commitment, announced for the next 4 years with major projects including the Queensland to Hunter Gas Pipeline and expansion of the Southwest Queensland Pipeline (AER 2008). All of this investment has been by the private sector, with the last government owned pipeline being sold in 2000.



**Figure 4.36** Development time for gas producing projects in Australia

Source: Geoscience Australia

There has also been significant investment in Australia's distribution networks, which have increased in length by around 20 per cent since 1997. Investment to expand and augment networks is forecast to grow by around \$2 billion for the next Australian Energy Regulator regulatory five year cycle (AER 2009).

The National Gas Law (NGL) and National Gas Rules (NGR) provide a regime to give third parties access to transmission pipelines and distribution networks. Pipelines and networks that have undue market power are regulated under the NGL & NGR, which requires them to publish tariffs that must be approved by the AER and which can be enforced by the AER in the event of a dispute. Eleven of Australia's 28 major transmission pipelines are regulated and, with a few exceptions, all distribution networks are regulated.

Most domestic gas is traded through bilateral contracts between producers and users (retailers and large customers) and, with the exception of the Victorian Gas Market, there is little price transparency. Also, the capacity on some transmission pipelines is fully contracted, making it difficult for new players to enter some gas markets. The Council of Australian Governments, through the Ministerial Council on Energy, is introducing reforms to Australia's gas markets to promote their ongoing development and address some of these issues. These reforms include:

- the National Gas Market Bulletin Board (Gas BB): The Gas BB website publishes daily supply and demand data for transmission pipelines in the eastern states with the aim of facilitating trade in gas and pipeline capacity.
- the Gas Statement of Opportunities (GSOO): An annual publication that provides 20 year forecasts of gas reserves, demand, production and transmission capacity for Australia's eastern and south eastern gas markets. The GSOO aims to assist existing industry participants and potential new investors in making commercial decisions about entering into contracts and investing in infrastructure.
- the Short Term Trading Market (STTM): Commences initially in Adelaide and Sydney in June 2010 with the intention it will be expanded to other jurisdictions in the future. The STTM will bring price transparency to these markets by setting a daily price for gas.

### Environmental and other considerations

The Australian state/territory governments require petroleum companies to conduct their activities in a manner that meets a high standard of environmental protection. This applies to the exploration, development, production, transport and use of Australia's gas and other hydrocarbon resources. Onshore and within three nautical miles of the

coastline the relevant state/territory government has the main environmental management authority although the Australian Government has some responsibilities regarding environmental protection, especially under the *Environmental Protection and Biodiversity Conservation (EPBC) Act 1999*.

An issue of increasing significance in gas exploration and development onshore, particularly for CSG, is gas water management which includes not only the handling of the co-produced water but also the hydrogeological impacts on subsurface aquifers. The potential impacts on groundwater resource(s) in the Surat Basin as a result of CSG developments were considered in detail in a water management study (DNRME 2004). Under the Queensland Coal Seam Gas Water Management Policy use of evaporation

ponds as a primary means of disposal of coal seam gas water is to be discontinued and CSG producers will be responsible for treating and disposing of coal seam gas water. Coal seam gas water will be required to be treated to a standard defined by the Environmental Protection Agency (EPA) before disposal or supply to other water users. There are a number of options for the disposal and treatment of the large volumes of water produced from CSG wells, such as deep injection into the subsurface, local use in coal washing and some rural purposes, and treatment to produce fresh water.

In the offshore areas beyond coastal waters the Australian Government has jurisdiction for the regulation of petroleum activities. The objective-based Petroleum (Submerged Lands) (Management

#### BOX 4.6 COMPARISON OF CONVENTIONAL AND UNCONVENTIONAL GAS DEVELOPMENTS

The properties of conventional gas and CSG accumulations have important implications for their development costs.

Conventional gas wells are generally drilled deep into highly pressured formations (2–4 km or more), and hence are relatively expensive. However, production wells can remain viable for 5 to 20 years and the often large, high pressure reservoirs can deliver gas at a faster rate than CSG.

CSG wells are shallow by comparison (less than 1 km), drilled into lower pressured formations and usually have a much shorter life (PricewaterhouseCoopers 2007). CSG typically emerges at a pressure of about one twentieth that of conventional gas and each well also normally produces a daily volume of only 5 per cent of a conventional gas well (Kimber and Moran 2004).

Conventional field developments tend to have high capital costs relative to operating costs, and long construction periods (up to five years for LNG projects).

CSG developments have lower capital costs, shorter construction times and minimal infrastructure per well, but higher operating costs. As CSG wells have significantly lower production rates, a larger number of wells are required to provide a level of production comparable to conventional offshore gas wells. The shorter well life for CSG wells also contributes to relatively higher operating costs. Further details on costs are in section 4.2.2

The IEA has produced a long term gas supply cost curve, which highlights the overall production costs of competing sources of gas, and the relative cost advantage of a conventional supply source. Other things being equal, conventional gas is likely to be developed first (figure 4.37).

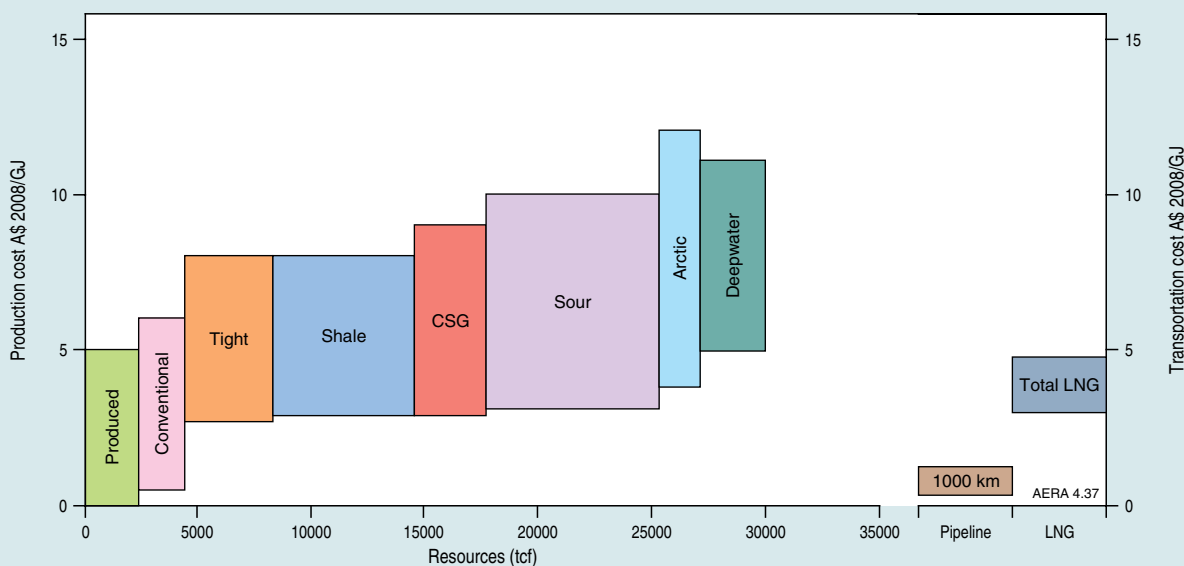


Figure 4.37 Long term gas supply cost curve showing relative production costs of different gas sources

Source: IEA 2009c

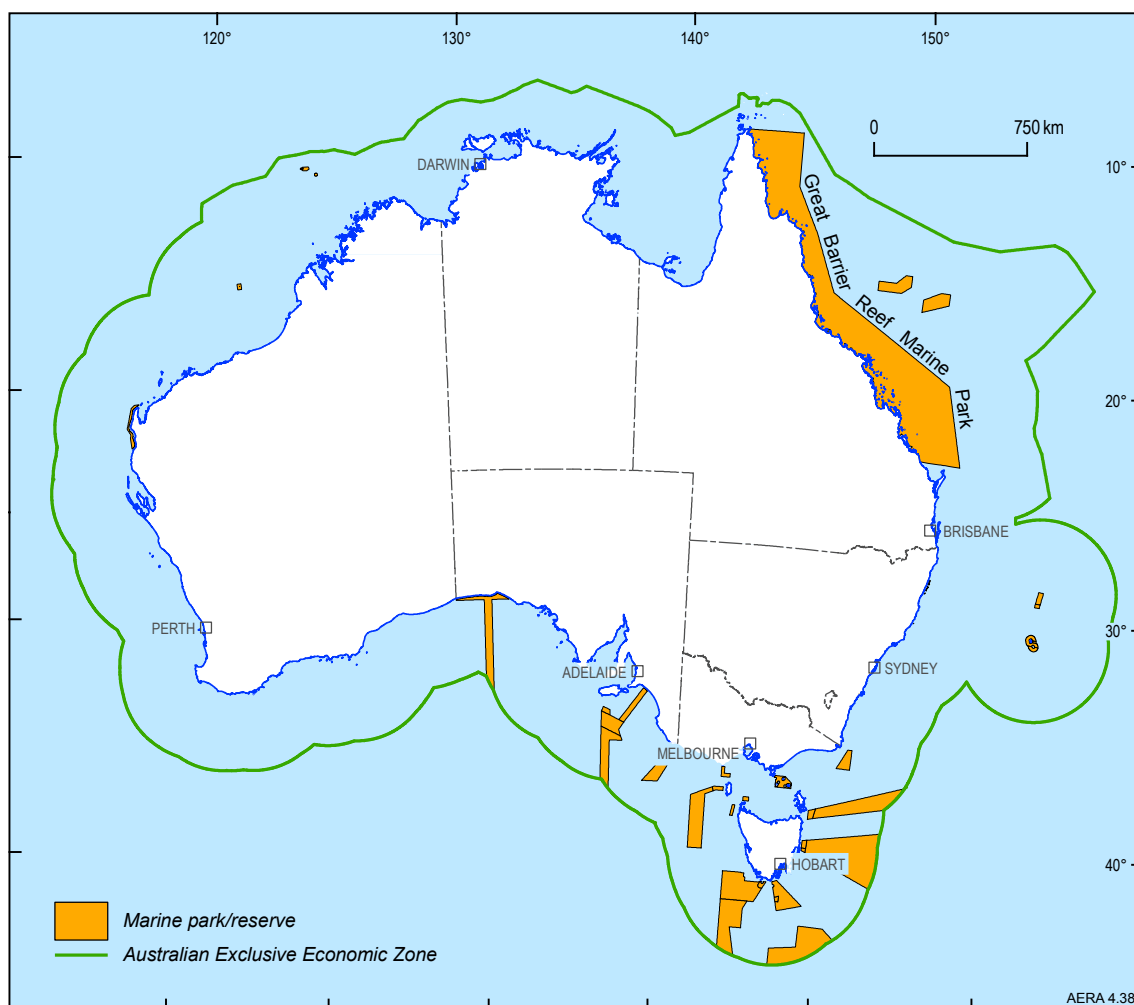


Environment) Regulations 1999 provide companies with the flexibility to meet environmental protection requirements. Petroleum exploration and development is prohibited in some marine protected areas offshore (such as the Great Barrier Reef Marine Park) and tightly controlled in others where multiple marine uses have been sanctioned (figure 4.38).

Environmental Impact Assessments (EIA) required as pre-conditions to infrastructure development applications – especially of larger projects – may require environmental monitoring over a period of time as a condition to the approval before the development can commence. In some cases regional-scale pre-competitive base line environmental information is available from government in the form of regional syntheses containing contextual information that already characterises the environmental conditions for the proposed development. In the offshore area typical data sets that are required for marine EIA in EPBC Act referrals and can be synthesised and made available by the Australian Government include: bathymetry, substrate type, seabed stability, ocean currents and processes, benthic habitats and biodiversity patterns.

The content of CO<sub>2</sub> in natural gas is an environmental consideration in some fields. The CO<sub>2</sub> content in gas fields varies widely and the liquids-rich gas accumulations of the Browse and Bonaparte basins tend to have relatively high CO<sub>2</sub> contents. Accessing this gas may require disposal of significant volumes (several tcf) of CO<sub>2</sub>. Geological storage is a possible option (box 5.4 in Chapter 5 Coal) and is being facilitated by the current carbon capture and storage (CCS) acreage release (Department of Resources, Energy and Tourism 2009). The Gorgon Project includes a major CO<sub>2</sub> injection component (Chevron Australia 2009).

There are also jurisdictional considerations. An offshore gas field which supplies an onshore gas plant requires federal, state or territory and local government co-ordination in resource management and development approvals processes (Productivity Commission 2009). Geological provinces containing gas resources that are contiguous across international boundaries, such as the JPDA in the Timor Sea, require international coordination.



**Figure 4.38** Current marine protected areas of Australia

Source: DEWHA 2009



## 4.4.2 Conventional gas resource outlook

Proven world natural gas reserves have grown at an annual rate of 3.4 per cent since 1980 – outstripping oil reserve growth – as a result of significant discoveries and better assessments of existing fields (World Energy Council 2007). In Australia, future growth in conventional gas, CSG and other unconventional gas resources will all add to an expanded total gas inventory by 2030, even with an increase in gas production.

For **conventional gas** resources, additions will come from several potential sources:

- field growth – extensions to identified commercial fields (growth in reserves) and to currently sub-economic fields;
- identified resources not yet booked – very recent discoveries, accumulations in non producing basins not in current EDR or SDR categories (inferred resources);
- discovery of new commercial fields in established hydrocarbon basins; and
- discovery of new fields in frontier basins that become commercial by 2030.

### Field reserves growth

Growth in reserves in existing fields can add significantly to total reserves. The additional conventional gas resource contributed by field growth by 2030 is estimated at between 35 200 and 46 200 PJ (32 and 42 tcf). This projection is consistent with actual historical data where reserves in fields discovered before 2002 have increased by 5.6 per cent in the period 2002 to 2007 giving an annual increase at the lower end of the projected range.

Powell (2004) provided qualitative assessments of the potential for future growth of gas reserves and noted that, as a large proportion of Australia's gas fields are undeveloped, there should be considerable potential for reserve growth. However, the advent of 3D and 4D seismic imaging should provide greater geological certainty and reduce the extent to which initial estimates of reserves are understated in the future.

### Identified resources not yet included in EDR or SDR

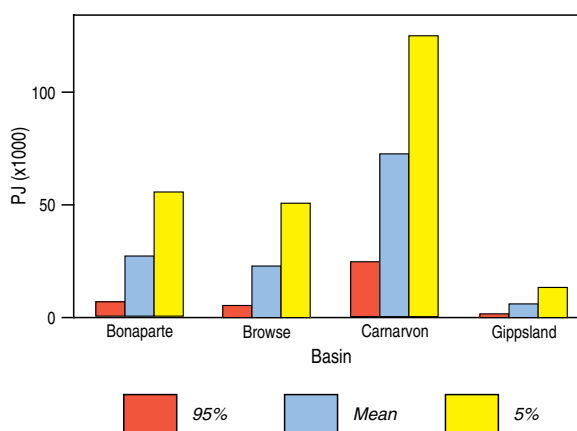
In addition to the 590 conventional gas fields in 14 basins aggregated in the EDR and SDR categories (Geoscience Australia 2009), there are a number of other known gas accumulations. They include recent discoveries not yet appraised (for example Martell, Glencoe, and Yellowglenn in the Carnarvon Basin and Burnside and Poseidon in the Browse Basin). Although located in deep water these accumulations could add significantly to gas resources when they are appraised. The potential and timing of

development of these discoveries will vary depending on location, resource size, quality (CO<sub>2</sub> and liquids content) and commercial factors (table 4.16).

In addition to very recent discoveries in established gas producing basins, there are a number of conventional gas accumulations in undeveloped basins both onshore and offshore (table 4.18) that are not aggregated in EDR or SDR. Examples include the Phoenix gas accumulation in the Bedout Sub-basin, the Hogarth accumulation in the Clarence Moreton Basin and gas flows from wells in the onshore Canning, Georgina and Ngalia basins. Remote location, size of the resource and resource quality (for example poor reservoir) are factors limiting their development but some of these accumulations may move into EDR and SDR in the years to 2030. For example, there may be local niche markets for conventional gas in power generation related to mineral processing or co-location with renewable but intermittent energy sources. Technological advances in producing gas from poor reservoirs may also lead to additional resources and some of these accumulations may eventually be produced as tight gas fields.

### Discovery of new fields in established hydrocarbon basins

A major potential contributor to Australia's conventional gas resources to 2030 is the discovery of new fields in the established hydrocarbon producing basins. Unlike the identified resources discussed above, discovery risk applies, so that the resource found by 2030 is dependent on the number of exploration wells drilled, the size of the prospects tested and the success rate. Active exploration programs are underway in the Carnarvon, Browse and Bonaparte basins, and recent success rates for targeted gas exploration in deep water are greater



**Figure 4.39** Estimates of undiscovered resources of conventional gas in four proven offshore basins

**Note:** 95%, Mean and 5% denote the probability of the resources exceeding the stated value

**Source:** USGS 2000

than 50 per cent. This is considerably higher than the historical success rates of around 20 per cent for petroleum exploration in Australian onshore and offshore basins.

Estimates of Australia's undiscovered conventional gas resources in four proven basins are shown in figure 4.39. This USGS (2000) assessment is substantially larger than the conservative short-time horizon Geoscience Australia estimates, to the extent that the P-95 per cent USGS estimates are closest to the P-5 per cent estimates by Geoscience Australia (Chapter 3 Oil provides a more detailed discussion of petroleum resource assessment methodologies). The USGS assessment represents the preferred indicative estimate of ultimate resource potential for these basins (Powell 2001) and is used to estimate potential resources from producing basins by 2030.

These estimates will have been influenced by a number of discoveries made since the USGS (2000) assessment was published. For example, the USGS (2000) mean estimate of 71 448 PJ (65 tcf) of gas remaining to be discovered in the Carnarvon Basin predates the giant Ito-Ito discovery which contains 20 tcf of gas (Walker 2007) and is one of the largest gas fields yet found in Australia. The gas is reservoirised in Late Jurassic channel sands (Jenkins et al. 2003) rather than in a Triassic fault block – the usual habitat of the other giant gas accumulations on the North West Shelf – and thus demonstrates a limitation of forward modelling when dealing with new play types.

Similarly, the assessment predates the Wheatstone (2004, 4364 PJ), Pluto (2005, 5101 PJ), and Xena (2006, 539 PJ) gas discoveries which highlight the

**Table 4.18** Status of gas exploration and discovery in Australia by basin

Basin	Status	First Discovery	Production/Commercial Discovery
Adavale	past gas producer	1964 – Gilmore	1995 – 2002 Gilmore gas production
Amadeus	gas producer	1965 – Palm Valley	1983 – gas piped to Alice Springs
Bass	gas producer	1967 – Bass-3 gas	2006 – BassGas project
Bonaparte	gas producer	1969 – Petrel	2006 – Darwin LNG production
Bowen	gas producer	1970 – Rolleston	1990 – Denison Trough gas piped to Brisbane
Browse	potential gas producer	1971 – Scott Reef	2009 – Ichthys project in FEED
Canning	potential gas producer	1966 – St Georges Range	
Carnarvon – onshore	gas producer	1966 – Onslow-1	1991 – Tubridgi gas production
Carnarvon – offshore	gas producer	1971 – North Rankin	1984 – NW Shelf gas piped to Perth
Carnarvon – Exmouth Pt.	potential gas producer	1980 – Scarborough	
Cooper	gas producer	1963 – Gidgealpa	1969 – gas piped to Adelaide
Eromanga	gas producer	1976 – Namur	1978 – Strzelecki 1st commercial oil
Georgina	gas flows	1973 – Ethabuka	
Gippsland	gas producer	1965 – Barracouta	1969 – gas piped to Melbourne
Gunnedah	gas producer	2000 – Coonarah	2004 – Wilga Park gas-fired power station
Maryborough	gas flows	1967 – Gregory River	CSG potential
Ngalia	gas flow	1981 – Davis	
Offshore Canning	gas flows	1980 – Phoenix	
Otway – onshore	gas producer	1959 – Port Campbell	1986 – gas piped to Warrnambool
Otway – offshore	gas producer	1993 – Minerva	2005 – Minerva gas production
Pedirka	gas shows		CSG potential
Perth – offshore	gas show	1978 – Houtman-1	
Perth – onshore	gas producer	1964 – Yardarino	1971 – Dongara production
Surat	gas producer	1900 – Hospital Hill	1969 – gas piped to Brisbane
Sydney	gas shows	1956 – Camden	CSG production
Tasmania	gas shows	1920 – Bruny Island	CSG, shale gas potential?

Source: Geoscience Australia

potential for further gas discoveries in the basin. More than 37 400 PJ (34 tcf) of conventional gas has been discovered in the Carnarvon Basin since 2000, exceeding the P50 Geoscience Australia estimate and representing approximately 40 per cent of the mean ultimate undiscovered gas resources estimated by the USGS.

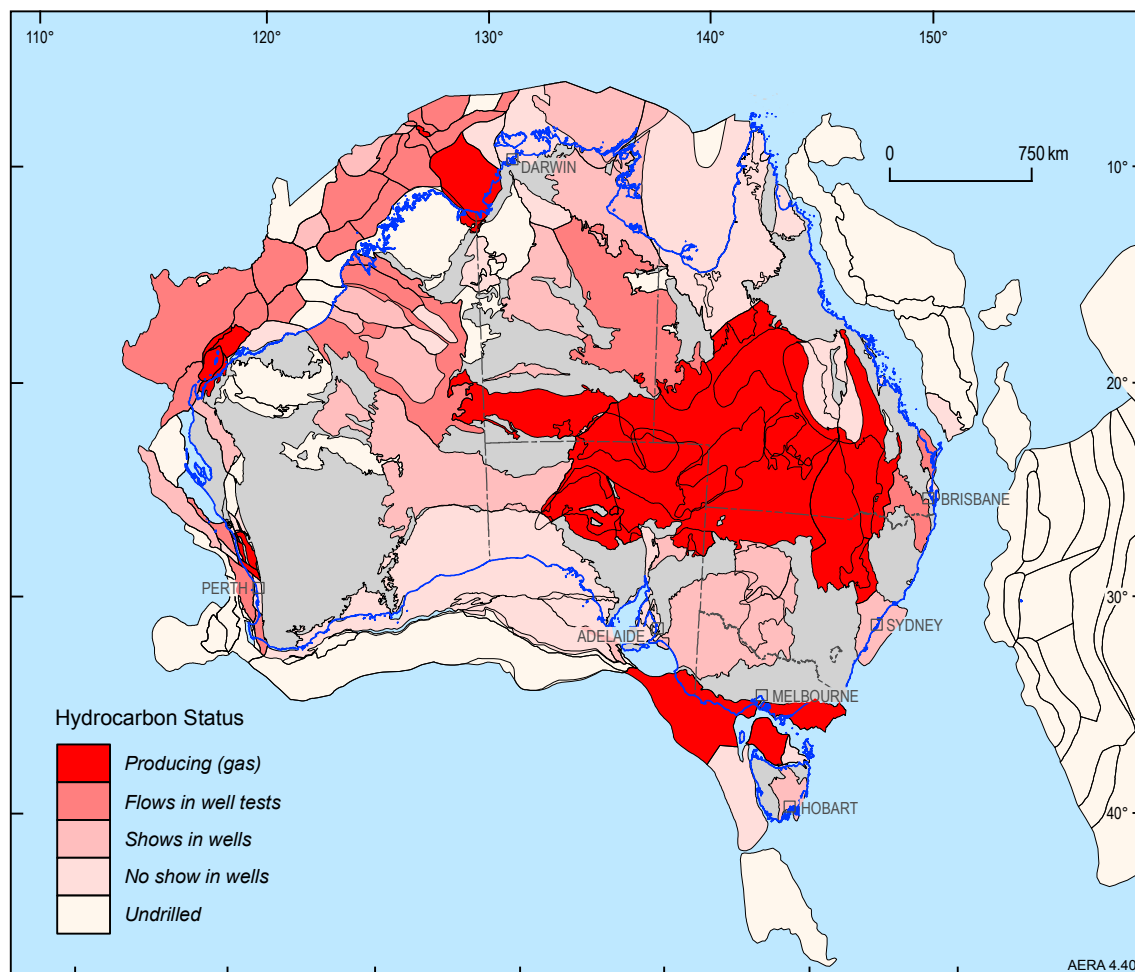
Undiscovered gas potential estimates for the Bonaparte Basin range from the 3198 PJ (3 tcf) of gas assessed by Barrett et al. (2002), using a medium-term discovery process model which makes a projection of resources expected to be found in the next 10 to 15 years, to the 25 935 PJ (23 tcf) USGS (2000) estimate of the ultimate hydrocarbon potential in the basin. The recent Blackwood, Caldita and Barossa gas discoveries, where exploration is continuing to define the size and quality of the accumulations, confirm the potential for remaining resources to be found in the Bonaparte Basin. The development of the second LNG hub at Wickham Point in Darwin Harbour to serve the development of the Ichthys gas accumulation in the Browse Basin is an added stimulus to the search for gas in northern Australia.

The USGS (2000) assessed Australia's producing onshore basins as having only modest potential for discovery of new resources – around 3 per cent of mean undiscovered gas (3590 PJ, 3.3 tcf). Exploration is continuing, especially in the Cooper-Eromanga but also the Bowen-Surat, Canning and Perth basins where there is potential for further discoveries of both conventional gas and coal seam gas.

#### Discovery of new fields in non-producing and frontier basins

In addition to the 14 basins that have identified commercial conventional gas resources, many other Australian basins have gas occurrences (figure 4.40). Apart from the gas accumulations already recognised in these basins there is also the potential for the discovery of new fields.

As gas exploration matures in the established basins, the size of drilling targets and correspondingly the size of discovered fields is likely to decline, unless reversed by new opportunities created by new play concepts and



**Figure 4.40** Australian gas occurrences, showing basins with conventional gas production, gas flows and gas shows, drilled basins with no shows and undrilled basins

**Note:** Identified gas resources, including relative size, shown in figure 4.1

**Source:** Geoscience Australia

technologies and, in the case of offshore basins, opportunities identified in deeper water. However, Australia's frontier basins are poorly explored and the largest structures remain untested.

Geoscience Australia is currently undertaking a program of pre-competitive data acquisition and interpretation to assess the petroleum potential of selected frontier basins. Most gas discoveries have been made during exploration for oil and that will lead the search into new deepwater basins; the potential of frontier basins is more fully discussed in Chapter 3 Oil.

In comparison to Australia's producing basins, there is a higher degree of uncertainty in estimating the undiscovered resources in the poorly explored frontier and non-producing basins. A number of estimates of undiscovered hydrocarbon potential are available for individual frontier basins and for Australia as a whole. The publicly available assessments have not integrated the results from the current rounds of pre-competitive data acquisition and focus on oil rather than gas resources. The recent USGS Circum-Arctic Resource Appraisal (2009) offers a possible approach to estimating undiscovered resources in frontier areas by using basin analogs.

#### 4.4.3 Unconventional gas resource outlook

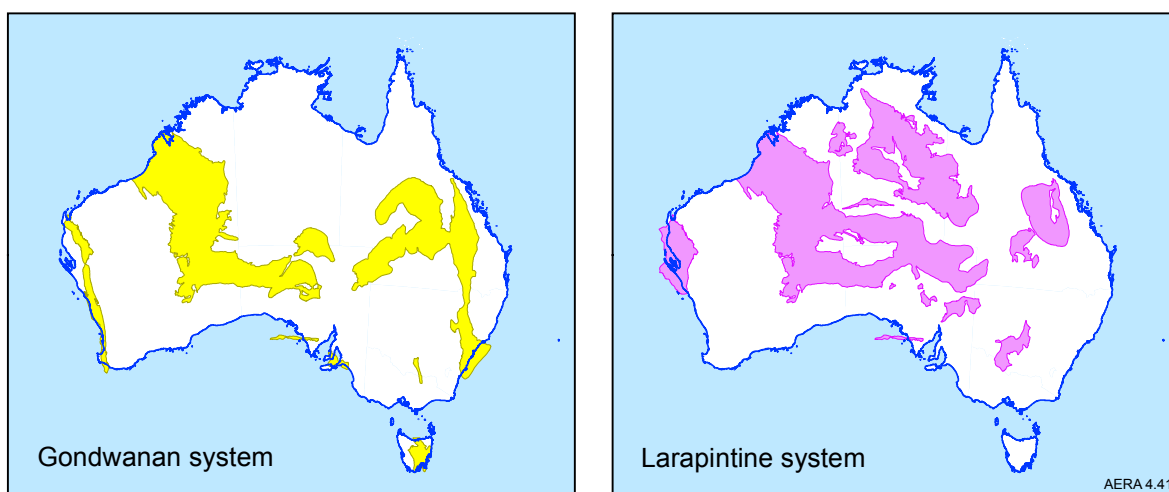
For unconventional gas the understanding of additions to the inventory of reserves from field growth and new discoveries is less well established than for conventional gas. In the outlook to 2030, CSG is expected to remain the most important sector of the unconventional gas industry; it is already a significant source of gas in eastern Australia. Currently, production of CSG is mainly from the Bowen and Surat basins in Queensland, with some production from the Sydney Basin in New South Wales. Production is from Permian and Jurassic coals.

Over the past five years the focus of CSG exploration has expanded into other coal basins and into other parts of the stratigraphy, to coal deposits of widely differing geological age. Triassic and Cretaceous strata are now also an exploration target as well as the Permian coals of the Gondwana basins (figure 4.41). CSG exploration in South Australia, Tasmania, Victoria and Western Australia has increased as a result of increasing CSG production in Queensland and the success in producing CSG from low rank coals in the United States. In South Australia, as at mid-2009, there were nine petroleum exploration licenses (PEL) granted and six under consideration for exploration rights to evaluate CSG potential (including underground coal gasification potential).

The Southern Cooper Basin is an area with potential for CSG resources contained within Permian coal seams intersected in previous petroleum exploration wells. The shallowest Permian coal measures in the Cooper Basin have thicknesses of up to 20 m with a total seam thickness of up to 80 m between depths of 1000 and 2000 m. There is also potential for shale gas and tight gas resources. A significant advantage of exploring for CSG in the Cooper Basin is that substantial gas infrastructure, including a gas pipeline servicing South Australia, Queensland and New South Wales markets, already exists.

Estimates of aggregate CSG potential in Australia are substantial (Baker and Slater 2009). Industry estimates range from 250 tcf (260 000 PJ) according to Santos (2009) to more than 300 tcf (300 000 PJ) of gas in place (Arrow Energy 2009).

In addition to the new CSG resources identified by current active exploration, it is expected that part of the large inferred in-ground resource will move into the EDR and SDR categories by 2030. There appears to be significant potential for at least 15 times more CSG than the current EDR.



**Figure 4.41** Distribution of Gondwanan (Permian) basins (potential CSG) and Larapintine (Early Paleozoic) basins (potential for shale gas resources)

Source: Bradshaw et al. 1994

Understanding of the future potential tight gas and shale gas resource in Australia is very limited. Likely shale gas candidate formations have been identified in the Cooper, Georgina and McArthur basins, where some exploration drilling has taken place in the Beetaloo sub-basin (Silverman et al. 2007). Apart from the organic rich shales in a number of Larapintine (figure 4.41) and Centralian basins (Bradshaw et al. 1994) across central and western Australia, there may also be shale gas potential in some of the less metamorphosed parts on the fold belts in eastern Australia. North American experience may provide a guide to future tight gas and shale gas potential in Australia. The rapid developments that have occurred there have resulted in shale gas reserves growing more than 50 per cent from 2007 to 2008. They now exceed CSG reserves (EIA 2009b).

As exploration and development of Australia's gas resources proceeds, several basins – notably the Cooper Basin – are likely to emerge as having conventional, CSG and tight or shale gas resources.

#### 4.4.4 Total gas resource outlook

Australia's EDR of gas, both conventional and unconventional, at 138 700 PJ (126 tcf) is equivalent to more than 70 years of production at current rates. Australian gas production is projected to increase significantly over the period to 2029–30 but demonstrated gas resources (226 500 PJ, 206 tcf) exceed the estimated cumulative gas production from 2008–09 to 2029–30 (119 060 PJ, 108 tcf). Total identified gas resources (393 000 PJ, 357 tcf) are nearly three times EDR and substantially larger than the estimated cumulative gas production from 2008–09 to 2029–30. Current identified gas resources remaining in 2030 are estimated to be equivalent to nearly 50 years of production at the estimated 2030 production rates. Over the outlook period it is expected that some of the currently sub-economic demonstrated resources (SDR) and large inferred (mostly CSG) gas resource will be converted to EDR and enter production. Australia's gas resource base is therefore more than adequate to support projected increases in production beyond the outlook period.

The true size of Australia's potential in-ground gas resources is unknown and could be significantly larger than the identified resources. There is no current publicly available resource assessment of Australia's undiscovered conventional gas resources that adequately reflects the knowledge gained in recent years during the active programs of government pre-competitive data acquisition and increased company exploration during the resources boom. In addition, the current knowledge base for unconventional gas, especially tight gas and shale gas, is inadequate for assessment. The potential

size of Australia's CSG resources is as yet ill-defined; companies have reported very substantial in-place CSG resources. Better assessment of Australia's potential gas resources would be aided by both more pre-competitive geoscientific information and further exploration drilling.

#### 4.4.5 Outlook for gas market

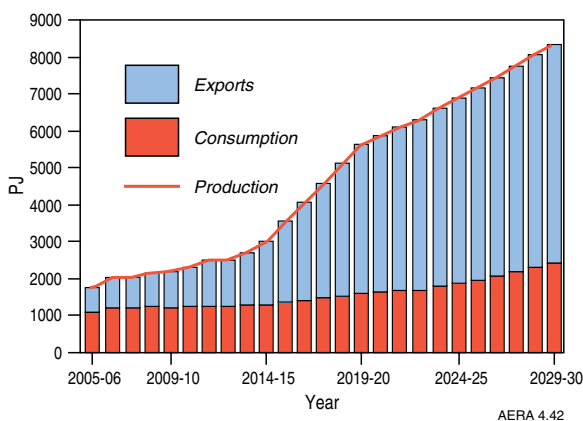
In the latest ABARE long-term projections (ABARE 2010) which incorporate the Renewable Energy Target, a 5 per cent emissions reduction target and other government policies, Australian gas production is projected to increase by 6.7 per cent per year, to reach 8505 PJ (7.7 tcf) in 2029–30 (tables 4.19 and 4.20). Australian gas consumption is projected to rise by 3.4 per cent per year to reach 2575 PJ (2.1 tcf) in 2029–30. Gas exports, in the form of LNG, are projected to expand even more quickly, by 9.5 per cent per year to reach 5930 PJ (109 Mt) in 2029–30. These results are discussed in more detail below.

#### Production

Over the medium term, the production of gas is expected to continue to rise as developments now under construction or in the advanced stages of planning are completed (figure 4.42).

Over the longer term, natural gas production is projected to increase to 8505 PJ by 2029–30, growing at an average annual rate of 6.7 per cent (figure 4.42). As with current production, the majority of future conventional gas production is likely to be sourced from offshore basins in north, north-west and south-east Australia. Western Australia is projected to account for nearly two thirds of this increase.

By 2029–30, total natural gas production in the Eastern market is projected to be around 2861 PJ (table 4.20). CSG production is projected to reach 2507 PJ in 2029–30, with CSG accounting for 88 per cent of the eastern Australian gas production. A significant proportion of this CSG will be consumed



**Figure 4.42** Outlook for Australian gas supply-demand balance

Source: ABARE 2010



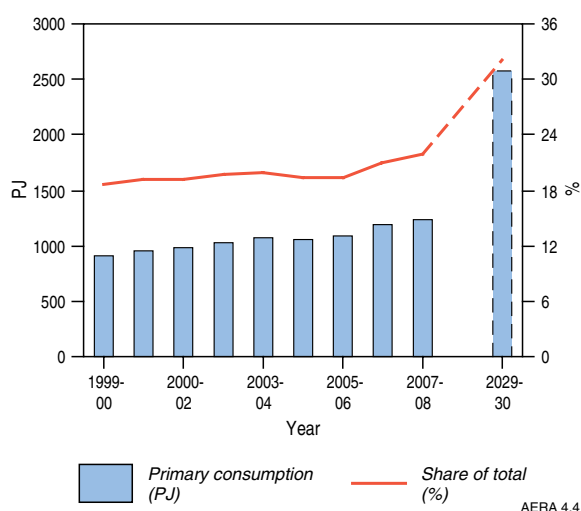
domestically, supporting the projected growth in gas-fired electricity generation, particularly in Queensland and New South Wales. The substantial projected expansion of CSG in Queensland would suggest that gas flow patterns may also change, with relatively less gas flowing north from Victoria, and more gas flowing south from Queensland. The positive outlook for natural gas production from CSG projects is projected to result in the eastern gas market remaining in balance over the projection period.

By 2029–30, gross natural gas production in the Northern Territory (including imports from the JPDA in the Timor Sea for LNG production) is projected to reach 677 PJ, growing at an average annual rate of 4.5 per cent. Gas supply to the Northern market (excluding LNG exports) is projected to meet demand over the outlook period, increasing to 93 PJ in 2029–30.

Gross natural gas production in the Western market, including LNG, is projected to grow strongly, at an average rate of 7.1 per cent per year, to reach 4968 PJ in 2029–30. This is underpinned by increasing demand in the domestic market and increasing global demand for LNG.

### Consumption

Gas is projected to be the fastest growing fossil fuel over the period to 2029–30. Primary gas consumption is projected to rise by 3.4 per cent per year over the outlook period to reach 2575 PJ by 2029–30 (figure 4.43). The share of gas in total primary energy consumption is projected to rise to 33 per cent in 2029–30. This growth in demand is driven primarily by the electricity generation sector and the mining sector, and reflects the shift to less carbon intensive fuels in a carbon constrained environment.



**Figure 4.43** Outlook for Australian gas consumption,  
Source: ABARE 2010

**Table 4.19** Outlook for Australia's gas consumption, production and trade

	unit	2029–30	Average annual growth 2007–08 to 2029–30
<b>Production</b>	PJ	8505	6.7
	tcf	7.7	-
Share of total	%	24.3	-
<b>Primary consumption</b>	PJ	2575	3.4
	tcf	2.3	-
Share of total	%	33.4	-
<b>Electricity generation</b>	TWh	135	5.0
	%	36.8	-
<b>Exports</b>	PJ	5930	9.5
	Mt	109	-

Note: Production includes imports from JPDA

Source: ABARE 2010

**Table 4.20** Outlook for Australia's gas markets,

	2029–30	Average annual growth 2007–08 to 2029–30
	PJ	%
<b>Eastern gas market</b>		
Production	2861	6.7
conventional gas	353	-2.2
coal seam gas	2507	14.9
Consumption	1501	3.6
Exports	1360	-
<b>Northern gas market</b>		
Production	677	4.5
Consumption	93	2.2
Exports	583	5.0
<b>Western gas market</b>		
Production	4968	7.1
Consumption	982	3.2
Exports	3986	9.0
<b>Australian total</b>		
Production	8505	6.7
Consumption	2575	3.4
Exports	5930	9.5

Note: Production includes imports from JPDA

Source: ABARE 2010



Gas-fired electricity generation and its share in total electricity generation are projected to increase considerably over the medium to long term. Electricity generation from natural gas is projected to grow at an average rate of 5 per cent per year to 135 TWh in 2029–30. The share of gas in total electricity generation is projected to grow to 37 per cent in 2029–30 (figure 4.44).

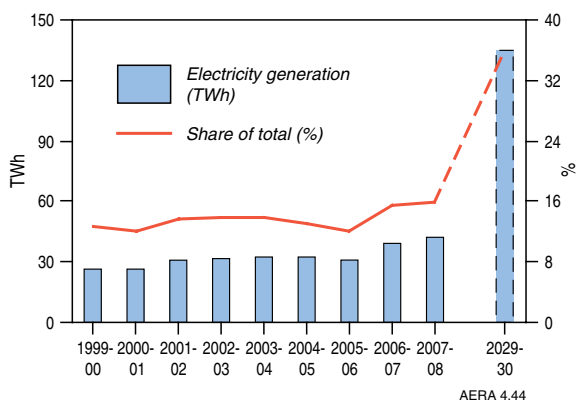
The projected increase in gas-fired electricity generation is supported by the significant volume of currently committed electricity generation capacity (see section on proposed project developments). Gas-fired electricity generation is based on mature technologies with more competitive cost structures relative to many renewable energy technologies. As such, it has the potential to play a major role in the transition period until lower-emission technologies become more viable.

### LNG exports

Australia is expected to significantly expand LNG exports over the next two decades. This reflects not only Australia's abundant gas reserves and their proximity to growing Asian Pacific markets, but also Australia's attractiveness as a reliable and stable destination for investment. CSG LNG is also expected to contribute significantly to the growth of the sector.

At the end of October 2009, there were two LNG plants under construction, the Pluto LNG project (annual capacity of 4.3 Mt) and the Gorgon LNG project (annual capacity of 15.0 Mt). The projects are scheduled to be completed by late 2010 and 2015 respectively. There are a number of other LNG plants that are at a less advanced stage (undergoing FEED studies), awaiting various government or internal approvals.

By 2029–30, LNG exports are projected to reach 109 Mt, reflecting an average annual growth rate over the outlook period of 9.5 per cent. Production of LNG is projected to increase its share of total Australian gas production to 70 per cent by 2029–30.



**Figure 4.44** Outlook for Australian gas-fired electricity generation

Source: ABARE 2010; IEA 2009a

## Proposed project developments

### Upstream

At the end of October 2009, there were eight upstream gas projects under construction or committed across Australia (table 4.21). Of these projects, four were located in the Carnarvon Basin, and others in the Otway and Gippsland basins. The projects have a combined gas production capacity of 1206 PJ per year. There are also five gas projects with a combined capacity of 176 PJ per annum at a less advanced stage of development (table 4.22).

There was also one upstream coal seam gas project under construction at the end of October 2009, located in the Bowen-Surat Basin in Queensland. This project will have a gas production capacity of 23 PJ per year. Several more CSG projects in Queensland and New South Wales are also at the planning stage (table 4.23).

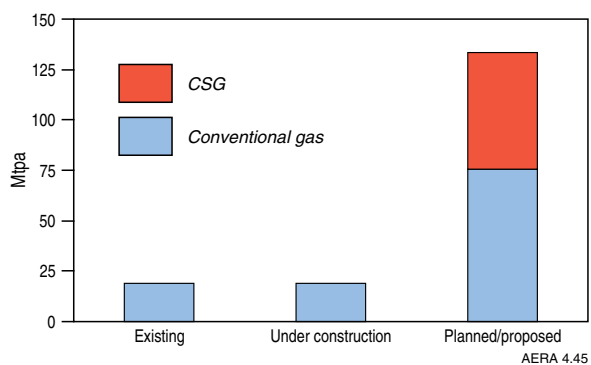
There are also several tight gas projects which have been proposed (table 4.24).

### Pipeline

Accompanying the expansion of Australia's gas production capacity is an expansion to the transmission pipeline. The largest expansion under construction, in terms of capacity, is the Stage 5B expansion of the Dampier Bunbury gas pipeline in Western Australia (table 4.25). The pipeline capacity will increase to 327 PJ per year when the Stage 5B expansion is completed. Several smaller pipeline expansions are committed or being constructed in New South Wales, Victoria, South Australia and Queensland.

### Electricity generation

At the end of October 2009 there were four advanced gas-fired electricity generation projects with a combined capacity of 1352 MW that are all scheduled to be in operation by the end of 2010. There are also two CSG-fired projects under construction, which would add a further 770 MW of capacity by the end of 2010 (table 4.26). In addition, there are a further 35 gas- and CSG-fired generation



**Figure 4.45** Proposed Australian LNG export capacity

Source: ABARE 2009c

projects at a less advanced stage with a combined capacity of more than 11 000 MW (table 4.27).

### LNG

There are a significant number of new LNG projects proposed in Australia. In addition to the 19 Mt of export capacity under construction, there is at least another 60 Mt (and potentially up to 76 Mt) of LNG projects based on conventional gas fields at various stages of FEED, feasibility and prefeasibility studies (table 4.28).

There are also at least five CSG-based LNG projects currently under consideration (table 4.29). All these projects are expected to be located in Queensland, with a combined capacity of around 35 Mt by the middle of next decade. This is similar to the LNG production capacity from conventional gas currently in existence or under construction located off the northwest coast of Australia. CSG projects represent about 40 per cent of the planned or proposed new LNG export capacity (figure 4.45).

If all of these proposed LNG export projects are realised, it would amount to more than five times

current export capacity. Several of the project developers have announced a planned or target start up date by the middle of this decade. However, it is not expected that all of these projects will actually be realised in the time frame announced.

Traditionally, LNG projects have not been developed until there is sufficient demand to underpin the required investment. A number of projects in table 4.28 have already been marketed for several years and their development date postponed to enable LNG markets to be secured. This is consistent with LNG projects in many other countries. Some of the projects are also targeting the same market opportunities.

While there is a move towards building some spare capacity, projects are still waiting to secure at least some long term contracts with buyers ahead of the commencement of construction. In addition to potential demand side constraints, Australia is competing with other planned projects around the world for limited resources to finance, design and construct LNG terminals.

**Table 4.21** Conventional gas projects at an advanced stage of development, as of October 2009

Project	Company	Basin	Status	Start up	Capacity	Capital Expenditure
Henry gasfield	Santos/ AWE/ Mitsui	Otway	Under construction	early 2010	11 PJ pa	\$275 m
Kipper gas project (stage 1)	Esso/ BHP Billiton/ Santos	Gippsland	Under construction	2011	30 PJ pa	US\$1.1 b (A\$1.3 b)
Longtom gas project	Nexus Energy	Gippsland	Under construction	2010	25 PJ pa	\$300 m
NWS CWLH <sup>a</sup>	Woodside Energy/ BHP Billiton/ BP/ Chevron/ Shell/ Japan Australia LNG	Carnarvon	Under construction	2011	35 PJ pa	US\$1.47 b (A\$1.8 b)
NWS North Rankin B	Woodside Energy/ BHP Billiton/ BP/ Chevron/ Shell/ Japan Australia LNG	Carnarvon	Under construction	2012	967 PJ pa	\$5.1 b (A\$6.1 b)
Pyrenees <sup>a</sup>	BHP Billiton/ Apache Energy	Carnarvon	Under construction	early 2010	23 PJ pa	US\$1.68 b (A\$2 b)
Reindeer gas field/Devil Creek gas processing plant (phase 1)	Apache Energy/ Santos	Carnarvon	Committed	late 2011	40 PJ pa	US\$744 m (A\$896 m)
Turrum	ExxonMobil/ BHP Billiton	Gippsland	Committed	2011	75 PJ pa	US\$1.25 b (A\$1.5 b)

<sup>a</sup> Oil developments with gas production capacity

Source: ABARE 2009c

**Table 4.22** Conventional gas projects at a less advanced stage of development, as of October 2009

Project	Company	Location	Status	Start up	Capacity	Capital Expenditure
Basker, Manta and Gummy gas development	Roc Oil/Beach Petroleum	Gippsland Basin	Feasibility study under way	na	up to 46 PJ pa	na
Brunello/Julimar (supply for Wheatstone LNG project)	Apache Energy/KUFPEC	Carnarvon Basin	Feasibility study under way	2013	na	US\$1.84 b (A\$2.2 b)
Halyard	Apache Energy/Santos	Carnarvon Basin	FEED studies under way	2011	26 PJ pa	US\$110 m (A\$133 m)
Kipper gas project (stage 2)	Esso/BHP Billiton/Santos	Gippsland Basin	Feasibility study under way	2015	27 PJ pa	na
Macedon	BHP Billiton/Apache Energy	Carnarvon Basin	Prefeasibility study under way	2013	77 PJ pa	na

Source: ABARE 2009c

**Table 4.23** CSG projects at various stages of development, as of October 2009

Project	Company	Location	Status	Start up	Capacity	Capital Expenditure
RTA development (Tallinga)	APLNG (Origin/ConocoPhillips)	East of Roma, Qld	Under construction	2010	23 PJ pa	\$260 m
Casino project	Metgasco	Casino, NSW	Feasibility study under way	2010	18 PJ pa	na
Gloucester project	AGL	Hunter Valley, NSW	Feasibility study under way	2010	15–25 PJ pa	\$200 m
Camden Gas Project	AGL	Camden, NSW	Planning approval received	na	12 PJ pa	\$35 m
Camden Gas Project	AGL	Camden, NSW	Planning approval under way	mid 2010	na	\$100 m
Walloon gas field	BG Group	North of Roma, Qld	Feasibility study under way	2013	190 PJ pa	\$230 m

Source: ABARE 2009c

**Table 4.24** Tight gas projects at various stages of development, as of October 2009

Project	Company	Location	Status	Start up	Capacity
Warro gas field	Alcoa/ Latent Petroleum	Perth Basin, WA	feasibility study under way	2012	up to 58 PJ
Wellesley gas field	Empire Oil and Gas/ Allied Oil and Gas	Perth Basin, WA	feasibility study under way	2010	na
Wombat field	Lakes Oil	Gippsland Basin, Vic	feasibility study under way	na	na
Wakefield-1	Adelaide Energy/ Beach Petroleum Ltd	Cooper Basin, SA	feasibility study under way	na	na

Source: ABARE

**Table 4.25** Gas pipelines at various stages of development, as of October 2009

Project	Company	Location	Status	Start up	Capacity	Capital Expenditure
Eastern Gas Pipeline	Jemena	Wollongong (NSW) to Longford (Vic)	Committed	2010	20 PJ pa	\$41 m
Moomba to Sydney	APA Group	Moomba (SA) to Sydney (NSW)	Under construction	2010	na	\$90 m
Queensland Gas Pipeline	Jemena	Wallumbilla to Gladstone (Qld) 550 km	Under construction	2010	25 PJ pa	\$112 m

Project	Company	Location	Status	Start up	Capacity	Capital Expenditure
South Gippsland natural gas pipeline	Multinet Gas	South Gippsland (Vic) 250 km from Lang Lang to five regional towns	Under construction	2010	na	\$50 m
Central Queensland gas pipeline	Arrow Energy/AGL	Moranbah to Gladstone (Qld) 440 km	Feasibility study under way	na	20–50 PJ pa	\$475 m
Dampier–Bunbury gas pipeline expansion (stage 5C)	DBP	Dampier to Bunbury (WA)	Feasibility study under way	na	100 PJ pa	\$800 m
Gloucester Coal Seam Gas pipeline	Lucas Energy/Molopo Australia	Gloucester to Hexham (NSW) 98 km	Feasibility study under way	2010	15–22 PJ pa	\$50–80 m
Lions Way pipeline	Metgasco	Casino to Ipswich (Qld) 145 km	EIS under way	na	18 PJ pa	\$120 m
Newstead to Bulla Park	Australian Pipeline Assets	Newstead (Qld) to Bulla Park (NSW)	Feasibility study under way	na	na	\$500 m
Queensland–Hunter gas pipeline	Hunter Gas Pipeline	Wallumbilla (Qld) to Newcastle (NSW) 820 km	Govt approvals received	2012	85 PJ pa	\$900 m
South West Queensland pipeline (stage 2 and 3)	Epic Energy	Wallumbilla to Ballera (Qld) 755 km	FEED study under way	2012	77 PJ pa	\$900 m
Surat Basin to Gladstone pipeline	Arrow Energy	Surat Basin to Gladstone (Qld) 450 km	EIS under way	na	na	\$600 m

Source: ABARE 2009c

125

**Table 4.26** Gas-fired power stations at an advanced stage of development, as of October 2009

Project	Company	Location	Status	Start up	Capacity	Capital Expenditure
<b>Conventional gas</b>						
Colongra gas project	Delta Electricity	NSW	Under construction	late 2009	660 MW	\$500 m
Owen Springs	Power and Water Corporation	NT	Under construction	2010	22 MW	\$130 m
Mortlake Stage 1	Origin Energy	Vic	Under construction	2010	550 MW	\$640 m
Kwinana Swift	Perth Energy	WA	Under construction	mid-2010	120 MW	\$120 m
<b>CSG</b>						
Condamine	BG Group/ANZ Infrastructure Services	8 km E of Miles, Qld	New project, under construction	2010	140 MW	\$170 m
Darling Downs	Origin Energy	40 km W of Dalby, Qld	New project, under construction	early 2010	630 MW	\$951 m (inc pipeline)

Source: ABARE 2009e

**Table 4.27** Gas-fired power stations at a less advanced stage of development, as of October 2009

Project	Company	Location	Status	Expected Startup	New Capacity	Capital Expenditure
<b>Conventional gas</b>						
ACT Peaker	AGL	8 km S of Canberra, ACT	New project, prefeasibility study under way	na	500 MW	\$350–450 m
Bamarang stage 1	Delta Electricity	7 km SW of Nowra, NSW	New project, govt approval received	na	300 MW	\$156 m
Bamarang stage 2	Delta Electricity	7 km SW of Nowra, NSW	Expansion, govt approval received	na	100 MW	\$400 m
Centauri 1	Eneabba Gas	8 km E of Dongara, WA	New project, govt approval received, on hold	na	168 MW	na
Hanging Rock stage 1	Loran Energy Products	20 km SW of Moss Vale, NSW	New project, govt approval under way	na	300 MW	\$360 m
Hanging Rock stage 2	Loran Energy Products	20 km SW of Moss Vale, NSW	Expansion, govt approval under way	na	300 MW	\$240 m
Leafs Gully	AGL	65 km SW of Sydney, NSW	New project, govt approval received	2011	360 MW	\$200 m
Marulan Gas Turbine Facility	EnergyAustralia	40 km NE of Goulburn, NSW	New project, EIS under way	2010	350 MW	\$280 m
Marulan Gas Turbine Facility stage 1	Delta Electricity	40 km NE of Goulburn, NSW	New project, EIS under way	2013–14	250–350 MW	\$280 m
Marulan Gas Turbine Facility stage 2	Delta Electricity	40 km NE of Goulburn, NSW	Expansion, EIS under way	2013–14	100–150 MW	\$235 m
Mortlake stage 2	Origin Energy	12 km W of Mortlake, Vic	Expansion, EIS completed	na	450 MW	na
Munmorah rehabilitation	Delta Electricity	Munmorah, NSW	Expansion, EIS under way	2013–14	100 MW	\$795 m
NQ Peaker	AGL	Townsville, Qld	New project, prefeasibility study under way	2011	360 MW	\$252–324 m
Parkes	International Power	Parkes, NSW	New project, govt approval received	na	120–150 MW	\$130 m
Pelican Point stage 2	International Power	20 km NW of Adelaide, SA	Expansion, prefeasibility study under way	na	300 MW	na
Port Kembla Steelworks Co-generation plant	BlueScope Steel	Port Kembla, NSW	New project, EIS under way	2012	220 MW	\$750 m
SEQ1	AGL	Ipswich, Qld	New project, prefeasibility study under way	2011	360 MW	\$252–324 m
SEQ2	AGL	Kogan, Qld	New project, prefeasibility study under way	2012	1150 MW	\$805–1035 m



Project	Company	Location	Status	Expected Startup	New Capacity	Capital Expenditure
Shaw River stage 1	Santos	30 km N of Port Fairy, Vic	New project, EIS under way	2012	500 MW	\$800 m (inc 105 km pipeline from Pt Campbell)
Shaw River stages 2 & 3	Santos	30 km N of Port Fairy, Vic	Expansion, EIS under way	na	2x500 MW	na
Swanbank F	CS Energy	Ipswich, Qld	Expansion, feasibility study under way	2012	400 MW	na
Tallawarra stage 2	TRUenergy Tallawarra	13 km S of Wollongong, NSW	Expansion, EIS under way	2015	300–450 MW	\$500 m
Tomago stage 1	Macquarie Generation	25 km N of Newcastle, NSW	New project, govt approval received, on hold	na	250 MW	\$700 m (inc Stage 1–3)
Tomago stage 2	Macquarie Generation	25 km N of Newcastle, NSW	Expansion, govt approval received, on hold	na	250 MW	\$700 m (inc Stage 1–3)
Tomago stage 3	Macquarie Generation	25 km N of Newcastle, NSW	Expansion, govt approval received, on hold	na	290 MW	\$700 m (inc Stage 1–3)
Valley Power Station Augmentation project	Snowy Hydro	Latrobe Valley, Vic	Expansion, govt approval received	2011	50–100 MW	\$80–100 m
Weddell stage 3	Power and Water Corporation	40 km SE of Darwin, NT	Expansion, feasibility study under way	late 2011	30 MW	\$86 m
Wellington	ERM Power	4 km N of Wellington, NSW	New project, govt approval received	2012	640 MW	\$350 m
<b>CSG</b>						
Braemar 3	ERM Power	40 km SW of Dalby, Qld	Expansion, govt approval received	2011	450 MW	na
Narrabri 1	East Coast Power	Narrabri, NSW	New project, planning approval under way	2012	30 MW	\$150 m (inc stages 1 and 2)
Narrabri 2	East Coast Power	Narrabri, NSW	New project, planning approval under way	2013	180 MW	\$150 m (inc stages 1 and 2)
Richmond Valley Power station and Casino Gas project	Metgasco	East Casino, NSW	New project, EIS under way	2010	30 MW	\$50 m
Spring Gully stage 1	Origin Energy	80 km N of Roma, Qld	New project, govt approval under way	na	500 MW	na
Spring Gully stage 2	Origin Energy	80 km N of Roma, Qld	Expansion, govt approval under way	na	500 MW	na
Wilga Park B	Eastern Star Gas	Narrabri, NSW	Expansion, planning approval received	na	30 MW	\$42 m

Source: ABARE 2009e

**Table 4.28** Conventional gas-based LNG projects at various stages of development, as of October 2009

Project	Company	Location	Status	Start up	Capacity	Capital Expenditure
Pluto (train 1)	Woodside Energy	Carnarvon Basin	Under construction	late 2010	4.3 Mt LNG	\$12 b (inc site works for train 2)
Gorgon LNG	Chevron/Shell/ExxonMobil	Carnarvon Basin	Under construction	2015	15 Mt LNG	\$43 b
Bonaparte (floating LNG)	Santos/GDF Suez	Bonaparte Basin	Prefeasibility study under way	na	2 Mt LNG	na
Browse LNG development	Woodside Energy/BP/BHP Billiton/Chevron/Shell	Browse Basin	Feasibility study under way	na	Up to 15 Mt LNG	na
Ichthys gasfield (incl Darwin LNG plant)	Inpex/Total	Browse Basin	FEED studies under way	2015	8 Mt LNG	US\$20 b (A\$24 b)
Pluto (train 2 and 3)	Woodside Energy	Carnarvon Basin	Feasibility study under way	na	8.6 Mt LNG	na
Prelude (floating LNG)	Shell	Browse Basin	Prefeasibility study under way	2016	3.5 Mt LNG	na
Scarborough Gas	ExxonMobil/BHP Billiton	Carnarvon Basin	Prefeasibility study under way	na	6 Mt LNG	na
Sunrise Gas project	Woodside Energy/ConocoPhillips/Shell/Osaka Gas	Bonaparte Basin	Prefeasibility study under way	na	5.3 Mt LNG	na
Timor Sea LNG project	Methanol Australia	Bonaparte Basin	Prefeasibility study under way	na	3 Mt LNG	na
Wheatstone LNG	Chevron/Apache Energy/KUFPEK	Carnarvon Basin	FEED study under way	2016	8.6 Mt LNG (initially) 25 Mt LNG (ultimately)	US\$17.8 b (A\$21 b)

Source: ABARE 2009c

**Table 4.29** CSG-based LNG projects at various stages of development, as of October 2009

Project	Company	Location	Status	Start up	Capacity	Capital Expenditure
Fisherman's Landing LNG project (Stage 1)	LNG Ltd/Golar/Arrow Energy	Gladstone, Qld	environment approval granted	late 2012	1.5 Mt LNG	\$500 m
Fisherman's Landing LNG project (Stage 2)	LNG Ltd/Golar/Arrow Energy	Gladstone, Qld	Feasibility study under way	na	1.5 Mt LNG	\$200–250 m
Curtis LNG project	BG Group	Gladstone, Qld	FEED study under way	late 2013	7.4 Mt LNG (12 Mt ultimately)	\$8 b (includes production wells, LNG plant and 380 km pipeline)
Gladstone LNG project	Santos/Petronas	Gladstone, Qld	EIS under way	2014	3.5 Mt LNG (initially)	\$7.7 b (includes production wells, 1 LNG train and 435 km pipeline)
Shell LNG	Shell	Gladstone, Qld	feasibility study under way	2014	14 Mt LNG (ultimately 16 Mt)	na
Australia Pacific LNG	APLNG (Origin/ConocoPhillips)	Gladstone, Qld	feasibility study under way	2014–15	7–8 Mt LNG (initially)	\$35 b (based on 14–16 Mt LNG) (includes production wells, 4 LNG trains and 400 km pipeline)

Source: ABARE 2009c

## 4.5 References

- ABARE (Australian Bureau of Agricultural and Resource Economics), 2009a, Australian Energy Statistics, Canberra, August
- ABARE, 2009b, Australian Commodities, vol. 16, no. 4, December quarter, Canberra
- ABARE, 2009c, Minerals and energy: Major development projects – October 2009 listing, Canberra, November
- ABARE, 2009d, Australian Commodity Statistics, Canberra, December
- ABARE, 2009e, Electricity generation: Major development projects – October 2009 listing, Canberra
- ABARE, 2010, Australian energy projections to 2029–30, ABARE research report 10.02, prepared for the Department of Resources, Energy and Tourism, Canberra
- Arrow Energy Ltd, 2009, Queensland Energy Conference, Brisbane, February
- AEMO (Australian Energy Market Operator), 2009a, Gas market data, <<http://www.aemo.com.au/>>
- AEMO, 2009b, Vision 2030 Update, May, <<http://www.aemo.com.au/planning/2030.html#>>
- AER (Australian Energy Regulator), 2009, State of the Energy Market 2009, Australian Competition and Consumer Commission, Melbourne, November
- AER, 2008, State of the energy market 2008, ACCC, Melbourne
- APPEA (Australian Petroleum Production and Exploration Association), 2009a, Canberra, October, <[http://www.appea.com.au/content/pdfs\\_docs\\_xls/PolicyIndustryIssues/appeasubmission\\_to\\_infrastructure\\_australia.pdf](http://www.appea.com.au/content/pdfs_docs_xls/PolicyIndustryIssues/appeasubmission_to_infrastructure_australia.pdf)>
- APPEA, 2009b, State of the Industry 2009, Canberra
- Baker GL and Slater SM, 2009, Coal seam gas – an increasingly significant source of natural gas in eastern Australia. The APPEA Journal 46 (1) 79–100
- Banks FE, 2000, Energy Economics: a Modern Introduction, Kluwer Academic Publishers, Boston, Dordrecht and London
- Barrett AG, Hinde AL and Kennard JM, 2004, Undiscovered resource assessment methodologies and application to the Bonaparte Basin. In: Ellis GK, Baillie PW and Munson TJ (eds), Timor Sea Petroleum Geoscience, Proceedings of the Timor Sea Symposium, Darwin, 19–20 June 2003. Northern Territory Geological Survey, Special Publication 1, 2004, 353–372
- BP, 2009, BP Statistical Review of World Energy, London, June
- Boreham CJ, Hope JM and Hartung-Kagi B, 2001, Understanding source, distribution and preservation of Australian natural gas: a geochemical perspective. The APPEA Journal 41 (1) 523–547
- Boreham CJ, Edwards DS, Hope JM, Chen J and Hong Z, 2008, Carbon and hydrogen isotopes of neo-pentane for biodegraded natural gas correlation. Organic Geochemistry 39, 1483–1486
- Bradshaw MT, Bradshaw J, Murray A, Needham DJ, Spencer L, Summons R, Wilmot J and Winn S, 1994, Petroleum systems in west Australian basins. In Purcell, PG & RR (Eds), The Sedimentary Basins of Western Australia. Proceedings of the Petroleum Exploration Society of Australia Symposium, Perth, 1994, 93–118
- Bradshaw MT, Foster CB, Fellows ME and Rowland DC, 1999, The Australian search for petroleum-patterns of discovery. The APPEA Journal, 39 (1), 1–18
- Branan N, 2008, Exploration and innovation: Geoscientists push the frontiers of unconventional oil and gas, <[http://www.jsge.utexas.edu/news/feats/2008/exploration\\_innovation.html](http://www.jsge.utexas.edu/news/feats/2008/exploration_innovation.html)>
- Campbell I, 2009, An Overview of Tight Gas Resources in Australia, PESA News, June/July issue
- Chevron Australia, 2009, Gorgon – its time is now, Perth, <<http://www.chevronaustralia.com/ourbusinesses/gorgon.aspx>>
- Costain, 2009, The case for floating LNG production, <<http://costain-floating-lng.com/floating-lng.php>>
- DEWHA (Department of the Environment, Water, Heritage and the Arts), 2009, Marine Protected Areas, <<http://www.environment.gov.au/coasts/mpa/index.html>>
- DNRME (Department of Natural Resources, Mines and Energy), 2004, Coal seam gas water management study, NRO0011, Report by Parsons Brinckerhoff Australia Pty Ltd for Queensland Department of Natural Resources, Mines and Energy, August 2004, <[http://www.dme.qld.gov.au/zone\\_files/None\\_Zoned\\_Files/csg\\_water\\_m\\_s\\_final.pdf](http://www.dme.qld.gov.au/zone_files/None_Zoned_Files/csg_water_m_s_final.pdf)>
- Draper JJ, and Boreham CJ, 2006, Geological controls on exploitable coal seam gas distribution in Queensland. The APPEA Journal 46 (1) 343–366.
- EIA (Energy Information Administration), 2009a, US Coal bed methane production, Energy Information Administration, Washington <<http://www.eia.doe.gov>>
- EIA, 2009b, US Crude oil, natural gas and natural gas liquids reserves, 2008. Energy Information Administration, Washington, <[http://www.eia.doe.gov/oil\\_gas/natural\\_gas/data\\_publications/crude\\_oil\\_natural\\_gas\\_reserves/cr.html?featureclicked=1&](http://www.eia.doe.gov/oil_gas/natural_gas/data_publications/crude_oil_natural_gas_reserves/cr.html?featureclicked=1&)>
- Frith D, 2004, Amity Oil remains optimistic. Prospect Magazine, December 2003-February 2004, Western Australia Department of Industry and Resources, page 6, <[http://www.dsd.wa.gov.au/documents/ProspectDec03-Feb04\(1\).pdf](http://www.dsd.wa.gov.au/documents/ProspectDec03-Feb04(1).pdf)>
- Geoscience Australia, 2009, Oil and Gas Resources of Australia 2008 Report <[http://www.ga.gov.au/oceans/pgga\\_OGRA.jsp](http://www.ga.gov.au/oceans/pgga_OGRA.jsp)>
- Green P and Randall R, 2008, Queensland's coal seam gas industry continues to brighten. Queensland Government Mining Journal, March 2008, 40–47
- Hogan L, Thorpe S, Zheng S, Ho Trieu L, Fok G and Donaldson K, 1996, Net Economic Benefits from Australia's Oil and Gas Resources: Exploration, Development and Production, ABARE Research Report 96.4, Canberra
- IEA (International Energy Agency), 2009a, World Energy Balances, 2009 edition, OECD, Paris
- IEA, 2009b, Natural gas information, 2009 edition, OECD, Paris
- IEA, 2009c, World Energy Outlook, OECD, Paris
- IEA, 2008, Natural gas market review 2008, OECD, Paris
- Jenkins CC, Maughan DM, Acton JH, Duckett A, Korn BE and Teakle RP, 2003, The Jansz gas field, Carnarvon Basin, Australia. The APPEA Journal 43(1), 303–324
- Kimber M and Moran A, 2004, More than Davy Lamps and Canaries – Coal Seam Gas in the 21st Century, Energy

- Issues paper No. 34, Institute of Public Affairs, Melbourne  
Lakes Oil, 2009, Tight Gas: A Lonely Journey, Lakes Oil, June
- Longley IM, Buessenschuett C, Clydsdale L, Cubitt CJ, Davis RC, Johnson MK, Marshall NM, Murray AP, Somerville R, Spry TB and Thompson NB, 2002, The North West Shelf of Australia – a Woodside perspective. In: Keep M and Moss SJ (editors), The Sedimentary Basins of Western Australia 3: Proceedings of the Petroleum Exploration Society of Australia Symposium, Perth, 27–88
- Magoon LB and Dow WG, 1994, The petroleum system. In Magoon LB and Dow WG (eds) The petroleum system – from source to trap. AAPG Memoir 60, AAPG, Tulsa, USA, 3-24
- Makogon YF, Holditch SA and Makogon TY, 2007, Natural gas-hydrates – a potential energy source for the 21st Century. *Journal of Petroleum Science and Engineering* 56 (2007) 14–31
- McCabe PJ, 1998, Energy resources – Cornucopia or empty barrel? *American Association of Petroleum Geologists Bulletin*, V 82, no. 11, 2110–2134
- McKirdy DM and Cook PJ, 1980, Organic Geochemistry of Pliocene-Pleistocene Calcareous Sediments, DSDP Site 262, Timor Trough. *American Association of Petroleum Geologists Bulletin*, Volume 64, 2118–2138
- MH21Research Consortium, 2009, Research Consortium for Methane Hydrate Resources in Japan, <<http://www.mh21japan.gr.jp/english/index.html>>
- Milkov AV, 2004, Global Estimates of Hydrate-bound Gas in Marine Sediments: How Much is Really Out There, *Earth-Science Reviews*, Vol. 66, 183–197
- Nippon GTL, 2009, Japan-GTL demonstration test project, <<http://www.nippon-gtl.or.jp/en/index.html>>
- Origin Energy, 2009, Waste and emissions – water from coal seam operations, <<http://www.originenergy.com.au/1748/Waste-and-emissions>>
- Pearce F, 2009, Ice on Fire. *New Scientist* 27 June, 30–33
- Powell TG, 2001, Understanding Australia's petroleum resources, future production trends and the role of the frontiers. *The APPEA Journal*, 41 (1), 273–288
- Powell TG, 2004, Australia's hydrocarbon resources – where will future production come from? *The APPEA Journal*, 44 (1), 729–740
- PricewaterhouseCoopers, 2007, Value and Growth in Coal Seam Methane, Brisbane, October
- Productivity Commission, 2009. Review of Regulatory Burden on the Upstream Petroleum (Oil and Gas) Sector, <<http://www.pc.gov.au/projects/study/upstreampetroleum>>
- Purcell PG and Purcell RR, 1988, The North West Shelf, Australia – An Introduction. In PG & RR Purcell (editors) Proceedings PESA North West Shelf Symposium, Perth 1988
- Queensland Department of Mines and Energy, 2009, Queensland Mining and Energy Bulletin, Brisbane, Autumn
- Santos, 2009, 2009 Energy White Paper Public Submission, May, <<http://www.ret.gov.au/energy/Documents/ewp/pdf/EWP%200046%20DP%20Submission%20-%20Santos.pdf>>
- Scott DJ, 2009, Gas hydrates: threat or opportunity? Groningen Gas 50 <<http://www.groningendgas50.nl/nl/site/conferentie/lezingen-17-juni>>
- Sharif A, 2007, Tight gas resources in Western Australia. In Petroleum in Western Australia September 2007, 28-31. Department of Mines and Petroleum, <[http://www.dmp.wa.gov.au/138\\_1491.aspx](http://www.dmp.wa.gov.au/138_1491.aspx)>
- Silverman MR, Landon SM, Leaver JS, Mather TJ and Berg E, 2007, No fuel like an old fuel: Proterozoic oil and gas potential in the Beetaloo Basin, Northern Territory, Australia. In Munson TJ and Ambrose GJ (eds) Proceedings Central Australian Basins Symposium (CABS), Alice Springs, August 2005. Northern Territory Geological Survey Special Publication 2, <[http://conferences.minerals.nt.gov.au/cabsproceedings/Final\\_papers/P37\\_Silverman\\_et\\_al.pdf](http://conferences.minerals.nt.gov.au/cabsproceedings/Final_papers/P37_Silverman_et_al.pdf)>
- Swart PK, Wortmann UG, Mitterer RM, Malone MJ, Smart PL, Feary DA and Hine AC, 2000, Hydrogen sulphide and saline fluids in the continental margin of South Australia. *Geology*, November 2000, v.28, no.11, 1039–1042
- USGS, 2000, US Geological Survey World Petroleum Assessment 2000 – Description and Results. USGS Digital data Series DDS-60
- Vu TAT, Horsfield B and di Primio R, 2009, A preliminary insight into the gas shale potential of the Amadeus and Georgina basins, Australia. GeoS4 Report 20090401, unpublished report to Geoscience Australia
- Walker TR, 2007, Deepwater and frontier exploration in Australia – historical perspectives, present environment and likely future trends. *The APPEA Journal*, 47 (1), 1–15
- Williamson PE and Kroh F, 2007, The role of amplitude versus offset technology in promotion offshore petroleum exploration in Australia, *The APPEA Journal*, 47 (1), 161–174
- World Energy Council 2007, Survey of Energy Resources 2007, London, <<http://www.worldenergy.org>>

# Chapter 5 Coal



## 5.1 Summary

### KEY MESSAGES

- Australia is the fourth largest producer, the largest exporter, and has the fourth largest reserves of coal in the world.
- Coal accounts for around three quarters of Australia's electricity generation, with coal-fired power stations located in every mainland state.
- Australia is well-placed to take advantage of increasing global demand for coal because of its large low-cost, high quality reserves.
- In export markets, coal remains the fastest growing fuel, driven by strong investment in coal-fired power stations in China and other developing economies.
- Within Australia, the share of coal in the energy mix is expected to decrease with the Renewable Energy Target and a proposed emissions reduction target.
- Government and industry initiatives are expected to play important roles in accelerating the construction, demonstration and commercial deployment of large-scale integrated carbon capture and storage (CCS) projects.
- Continuing investment in infrastructure will be necessary to enable Australia to remain a major player in the world coal market.

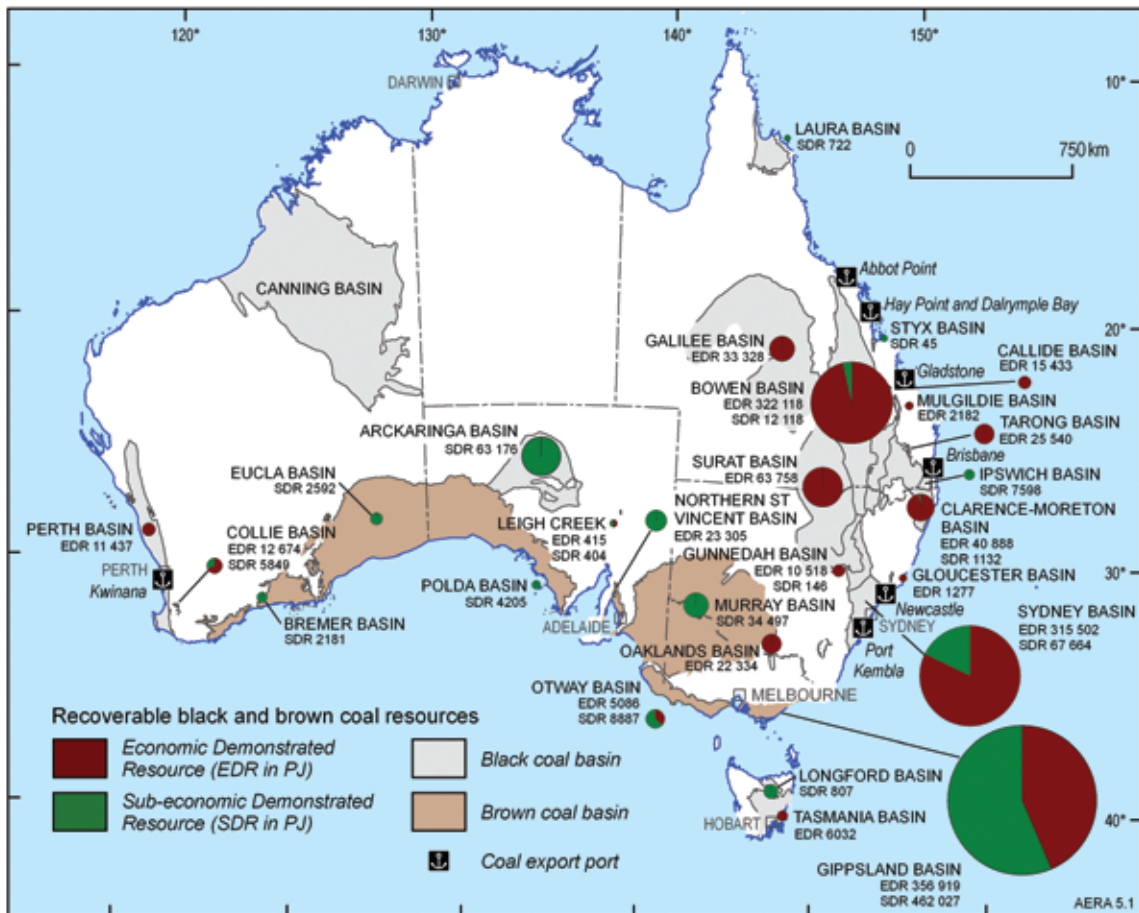
### 5.1.1 World coal resources and market

- World coal production and consumption was 6.7 billion tonnes (Gt) or around 133 000 petajoules (PJ) in 2008, and has grown at a rate of 5.2 per cent per year since 2000.
- Global proved coal reserves (both black and brown) were estimated at 826 Gt at the end of 2008.
- Trade in black coal was 939 million tonnes (Mt) in 2008, with thermal coal at 704 Mt and metallurgical coal at 235 Mt.
- Coal accounted for 26 per cent of world primary energy consumption and 42 per cent of world total electricity generation in 2007.
- Global coal consumption slowed in 2008 but coal remained the fastest-growing fossil fuel with a 5 per cent growth in consumption: China accounted for most of the growth.
- In its reference case, the IEA projects world coal demand to increase at an average annual rate of 1.9 per cent between 2007 and 2030. Non-OECD demand is projected to increase at an average annual rate of 2.8 per cent, while OECD demand is projected to decline by 0.2 per cent per year.
- The share of coal-fired electricity generation is projected to increase from 42 per cent in 2007 to 45 per cent in 2030.

### 5.1.2 Australia's coal resources

- Coal is Australia's largest energy resource. It is low cost and located close to areas of demand.
- Australia has substantial reserves of both black and brown coal, including high quality thermal and metallurgical coal.
- At end of 2008, Australia's recoverable Economic Demonstrated Resources (EDR) of black coal amounted to 39.2 Gt, some 6 per cent of the world's recoverable EDR. In addition there are another 8.3 Gt of Sub-economic Demonstrated Resources (SDR).
- At the 2008 rate of production of around 490 Mt per year the EDR are adequate to support about 90 years of production.
- In addition to EDR and SDR there is 66.6 Gt of recoverable Inferred Resources of black coal, which require further exploration to delineate their possible extent and determine their economic status.
- Queensland (56 per cent) and New South Wales (40 per cent) have the largest share of Australia's black coal EDR with the Sydney (35 per cent) and Bowen (34 per cent) basins containing most of the recoverable black coal EDR (figure 5.1).





**Figure 5.1** Australia's total recoverable resources of black and brown coal as at December 2008

Source: Geoscience Australia

- Australia has about 25 per cent of the world's recoverable brown coal EDR. Australia's recoverable EDR of brown coal stand at 37.2 Gt, with another 55.1 Gt in the SDR category and a further 101.8 Gt in the Inferred category. Brown coal EDR are sufficient for around 490 years at current rates of production.
- The potential for further discoveries of coal resources in Australia is significant and is probably over one trillion tonnes given that there are over 25 sedimentary basins with identified resources or coal occurrences and that there are significant areas within these basins that are under-explored.
- At end of 2009, there were over 100 operating coal mines and more than 35 proposed new mines and expansions at various stages of development ranging from scoping studies to construction (figure 5.2).
- Australia's coal industry provides direct employment for about 30 000 people.

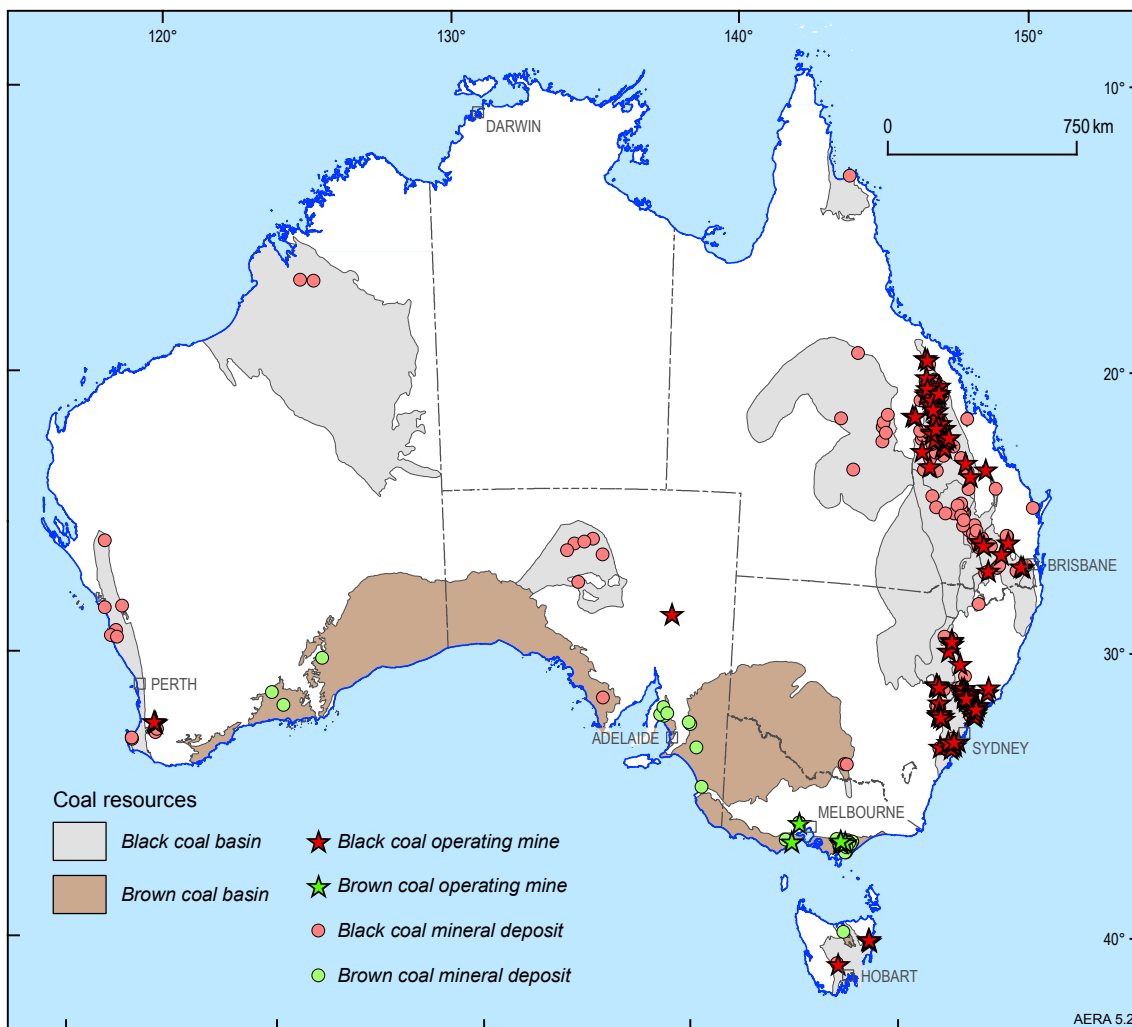
### 5.1.3 Key factors in utilising Australia's coal resources

- World demand for energy and the evolution of coal

prices over the period to 2030 will affect the export market and, thus, Australia's black coal production.

- Exports and domestic use of coal in electricity generation are likely to be strongly influenced by:
  - increasing electricity demand in non-OECD economies associated with economic growth;
  - global and domestic emissions reduction policies;
  - cost and rate of deployment of new low emissions technologies (e.g. carbon capture and storage); and
  - competition and substitution from other forms of energy including gas, nuclear, wind, geothermal and solar.
- Adequacy and ease of access for exporters to infrastructure, particularly port and rail.
- Government and industry initiatives such as the Global Carbon Capture Storage Institute, the Carbon Capture Storage Flagships program, and the Coal21 program are likely to play an important role in the development and commercial deployment of new low emissions technologies in the outlook period.





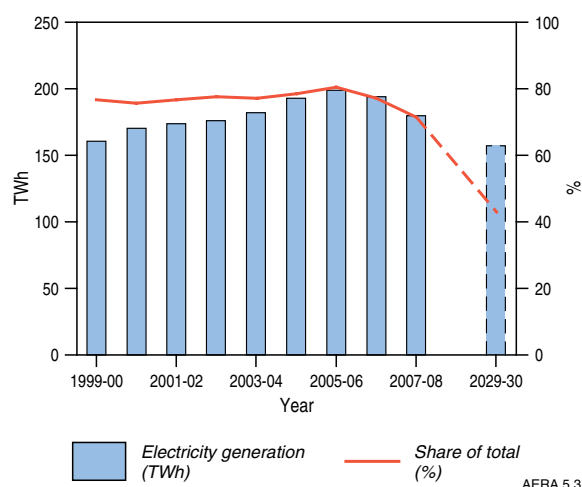
**Figure 5.2** Australia's operating black and brown coal mines as at December 2008

Source: Geoscience Australia

#### 5.1.4 Australia's coal market

- Australian coal production has increased at an average annual rate of 3.3 per cent between 2000 and 2008 and domestic consumption has increased at an average annual rate of 1.6 per cent over the same period.
- Coal is currently used to generate around three quarters of Australia's electricity, and in 2007–08 accounted for 40 per cent of total primary energy consumption.
- New South Wales and Queensland are the largest producing states in Australia.
- Australia exported 7183 PJ (252 Mt) of black coal in 2007–08, of which around 54 per cent was metallurgical coal and 46 per cent was thermal coal. Exports were valued at \$24.4 billion.
- In the latest ABARE energy projections that include the RET and a 5 per cent emissions reduction target, Australia's coal production is projected to increase at an average annual rate of 1.8 per cent to 13 875 PJ between 2007–08 and 2029–30.

- Over the same period, domestic coal consumption is projected to decline at an average annual rate of 0.8 per cent to around 1763 PJ in 2029–30.



**Figure 5.3** Australia's coal-fired electricity generation to 2029–30

Source: IEA 2009b; ABARE 2010

- Coal's share of primary energy consumption is projected to decline to about 23 per cent in 2029–30.
- Coal's contribution to Australia's electricity generation is also projected to decrease to around 43 per cent in 2039–30 (figure 5.3).
- This decline in coal's contribution to electricity generation is expected to be taken up by gas and to a lesser extent renewable energy sources.
- Exports are projected to increase at an average annual rate of 2.4 per cent to 12 100 PJ (450 Mt) in 2029–30. The increase in exports reflects strong growth in coal demand in China, India and other developing economies, a proportion of which will be imported.

## 5.2 Background information and world market

### 5.2.1 Definitions

Coal is a combustible sedimentary rock formed from ancient vegetation which has been consolidated between other rock strata and transformed by the combined effects of microbial action, pressure and heat over a considerable time period. This process is commonly called 'coalification'. Coal occurs as layers or seams, ranging in thickness from millimetres to many tens of metres. It is composed mostly of carbon (50–98 per cent), hydrogen (3–13 per cent) and oxygen, and smaller amounts of nitrogen, sulphur and other elements. It also contains water and particles of other inorganic matter. When burnt, coal releases energy as heat which has a variety of uses.

Coal is broadly separated into brown and black which have different thermal properties and uses.

**Brown coal (lignite)** has a low energy and high ash content. Brown coal is unsuitable for export and is used to generate electricity in power stations located at or near the mine.

**Black coal** is harder than brown coal and has a higher energy content. In Australia anthracite, bituminous and sub-bituminous coals are called black coal whereas in Europe, sub-bituminous coal is referred to as brown coal (table 5.1) .

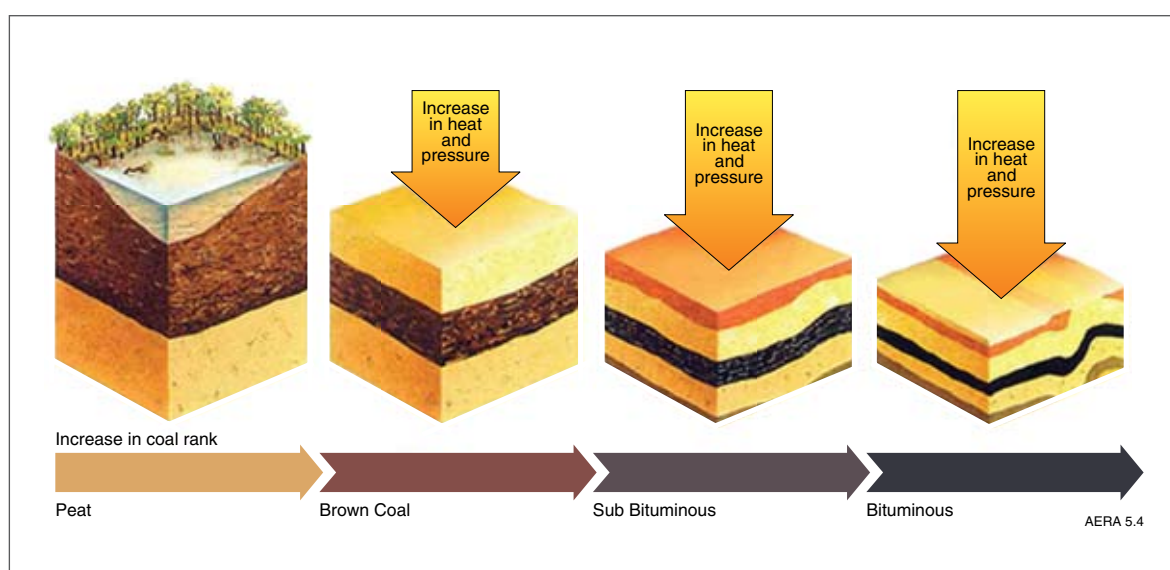
**Thermal (steaming) coal** is black coal that is used mainly for generating electricity in power stations where it is pulverised and burnt to heat steam-generating boilers.

**Metallurgical (coking) coal** is black coal that is suitable for making coke, which is used in the production of pig iron. These coals must also have low sulphur and phosphorus contents, and are relatively scarce and attract a higher price than thermal coals.

**Coke** is a porous solid composed mainly of carbon and ash and is used in blast furnaces that produce iron.

**Table 5.1** Coal classification terminology used in Australia and Europe

Coal Rank	Australian Terminology	European Terminology
Anthracite	Black Coal	Black Coal
Bituminous Coal	Black Coal	Black Coal
Sub-bituminous Coal	Black Coal	Brown Coal
Lignite	Brown Coal	Brown Coal



**Figure 5.4** Diagrammatic representation of the transformation of peat to brown and black coal (increasing coal rank)

Source: Australian Coal Association 2009

Coal has a wide range of chemical and physical properties, reflecting its transformation by increasing pressure and temperature from peat, the precursor of coal, to the low rank (low organic maturity) lignite or brown coal and to the more mature sub-bituminous coals and ultimately to the harder, mature (higher rank) black coals (figure 5.4). The lower rank sub-bituminous coals, with lower energy contents (lower carbon and higher moisture contents), and lignite are mainly used for power generation. Bituminous coal (table 5.1) has a higher volatile content, lower fixed carbon and therefore a lower energy content than anthracite. It is used for power generation, metallurgical applications, and general industrial uses including cement manufacture. Anthracite, the highest rank of the black coals, has the lowest moisture content and the highest carbon and energy content, and is used mainly by industry for steel and cement manufacturing. Most Australian black coals are of good quality with low ash and sulfur contents.

In the remainder of this chapter, coal is the sum of brown and black coal unless otherwise specified. All production referred to is saleable coal, rather than raw, unless stated otherwise.

### 5.2.2 Coal supply chain

Figure 5.5 gives a schematic view of the coal industry in Australia. Coal resources are delivered to domestic and export markets through the successive activities of exploration, development, production, processing, and transport.

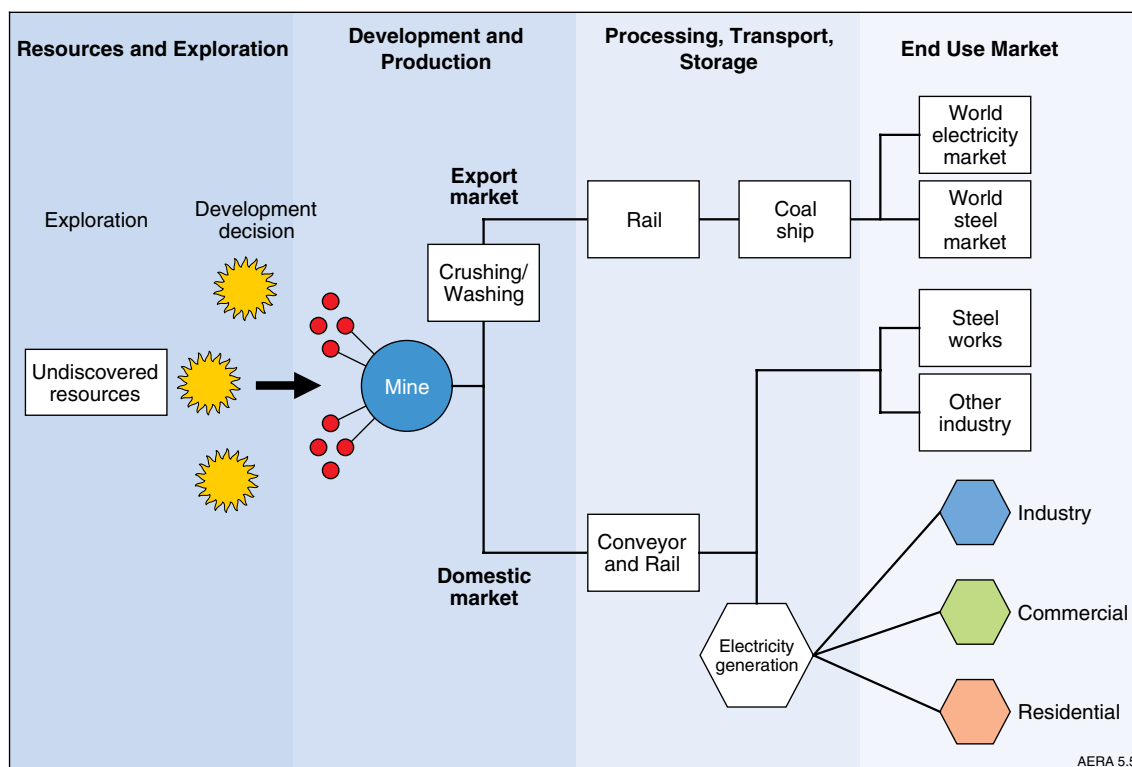
### Exploration

Coal reserves are discovered through exploration. Modern coal exploration typically involves extensive use of geophysical surveys, including 3D seismic surveys aimed at providing detailed information on the structures with the potential to affect longwall operations, and drilling to determine coal quality and thickness.

### Mining

Coal is mined by both surface or ‘opencut’ (or opencast) and underground or ‘deep’ mining methods, depending on the local geology of the deposit. Underground mining currently accounts for about 60 per cent of world coal production but around 80 per cent of Australia’s coal is produced from opencut mines. Opencut mining is only economic when the coal seam(s) is near the surface. It has the advantage of lower mining costs and it generally recovers a higher proportion of the coal deposit than underground mining, as most seams present are exploited (90 per cent or more of the coal can typically be recovered).

Technological advancements have made coal mining today more productive than it has ever been. Modern large opencut mines can cover many square kilometres in area and commonly use large draglines to remove the overburden and bucket wheel excavators and conveyor belts to transport the coal. Modern equipment and techniques allow opencut mining to around 200 m. Many underground coal mines in Australia use longwall mining methods,



**Figure 5.5** Australia’s coal supply chain

**Source:** ABARE and Geoscience Australia

which enable extraction of most of the coal from a seam using mechanical shearers. The mining 'face' can be up to 250 m long. Self-advancing, hydraulic-powered supports temporarily hold up the roof while the coal is extracted. The roof over the area behind the face, from which the coal has been removed, is then allowed to collapse. Over 75 per cent of the coal in the deposit may be extracted using this method (World Coal Institute 2009).

### Processing

Black coal may be used without any processing other than crushing and screening to reduce the rock to a useable and consistent size and remove some contaminants. However, coal for export is generally washed to remove pieces of rock or mineral which may be present. This reduces ash and increases overall energy content. Coal is separated into size fractions, with coarse coal usually separated by dense medium cyclones using a slurry of magnetite

and water. High density particles with concentrations of mineral matter sink and particles with low mineral matter concentrations float. Fine coal (minus 1 mm) is usually cleaned by flotation, where the addition of reagents enables the coal to attach to bubbles and is separated from mineral matter. Coal is dewatered after washing for efficient transport and use.

### Transport

Australia's coal is transported by conveyor or rail to power stations for domestic electricity production or via rail to coal export terminals from where it is shipped in Panamax and Capesize vessels to markets all over the world. In New South Wales, coal for export is loaded at two ports: Port Kembla (80 km south of Sydney) and Newcastle (150 km north of Sydney). Port Kembla serves the western and southern coalfields. The port of Newcastle serves mines in the Hunter Valley and Gunnedah basins and is the world's largest coal export port. In Queensland, there are six coal loading terminals:

**Table 5.2** Key coal statistics

	unit	Australia 2007-08	Australia 2008	OECD 2008	World 2008
<b>Reserves</b>	Mt	-	76 400	352 095	826 001
Share of world	%	-	9.2	42.6	100
World ranking	No	-	4	-	-
<b>Production (Raw Coal)</b>	PJ	9431	9691	-	-
	Mt	487	497	2127	6666
Share of world	%	-	7.4	31.9	100
World ranking	No	-	4	-	-
Annual growth in production 2000-08	%	-	3.3	0.7	5.2
<b>Primary energy consumption</b>	PJ	2292	2309	47 461	133 215 <sup>a</sup>
	Mt	135	136	2329	6767 <sup>a</sup>
Share of world	%	-	2.0	34.4	100
World ranking	No	-	10	-	-
Share of primary energy consumption		40	-	21	26 <sup>a</sup>
Annual growth in consumption 2000-08	%	-	1.6	0.7	4.8
<b>Electricity generation</b>					
Electricity output	TWh	-	202	3947	8216 <sup>a</sup>
Share of total	%	-	76	33	42 <sup>a</sup>
<b>Exports</b>	Mt	252	261	385	939
Thermal coal	Mt	115	126	175	704
Share of world	%	-	18	25	100
World ranking	No	-	2	-	-
Export value	A\$b	8.4	14.4	-	-
Metallurgical coal	Mt	137	135	210	235
Share of world	%	-	57	89	100
World ranking	No	-	1	-	-
Export value	A\$b	24.4	32.3	-	-

<sup>a</sup> 2007

Source: ABARE 2009a, b; IEA 2009a, b

Abbot Point, Dalrymple Bay, Hay Point, Gladstone (RG Tanna and Barney Point) and Fisherman Island in the port of Brisbane. The port of Brisbane services the Clarence-Moreton Basin with the other five terminals loading coal produced in the Bowen Basin. Some coal has recently been exported from Kwinana in Western Australia.

### 5.2.3 World coal market

Table 5.2 provides key statistics for the Australian coal market within a global context. Australia is a major producer and exporter of coal, having large, low-cost reserves available. Coal also plays a dominant role in Australia's and the world's energy mix.

#### Reserves and production

Over 70 countries worldwide have proven reserves of coal totalling approximately 826 Gt (World Coal Institute 2009). At current rates of production, these reserves are estimated to last 122 years (BP 2009). The United States has large reserves of both black and brown coal, and accounts for 29 per cent of total world coal reserves (figure 5.6). China and India also hold large reserves of black coal, while China and the Russian Federation hold large reserves of brown coal. Australia's reserves of black coal are the fifth largest in the world, while its reserves of brown coal are the fourth. Total coal reserves (based on EDR) in Australia are 76.4 Gt, 9 per cent of the world's total.

In 2008, world coal production totalled 6.7 Gt, of which the largest producers, China, United States and India accounted for 40 per cent, 16 per cent and 8 per cent respectively. Australia's production of 497 Mt was the fourth largest and accounted for about 7 per cent of world production (figure 5.7).

Of total coal production, black coal accounted for 86 per cent, while brown coal accounted for the remaining 14 per cent (figure 5.8).

#### Primary energy consumption

In 2008, world coal consumption was around 6.8 Gt (IEA 2009a). The major use of coal is for electricity generation (accounting for around 67 per cent of consumption) and steel production (16 per cent). Other uses include cement production and chemical processing.

Coal is an important energy source, reflecting its wide availability and relatively low cost compared with other fuels. In 2007 it accounted for 26 per cent of global primary energy consumption, the second largest share of world energy consumption after oil. Around 42 per cent of the world's electricity is generated using coal and around 70 per cent of the world's steel production is from the coal-based blast furnace process.

China is the largest coal consumer accounting for around 41 per cent of world consumption in 2008 (figure 5.9). China's consumption has increased at

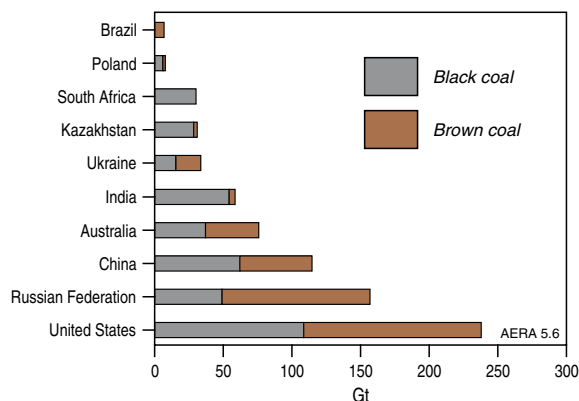


Figure 5.6 Black and brown coal reserves, major countries, 2008

Note: BP defines black coal as anthracite and bituminous coal, and brown coal as sub-bituminous and lignite

Source: BP 2009

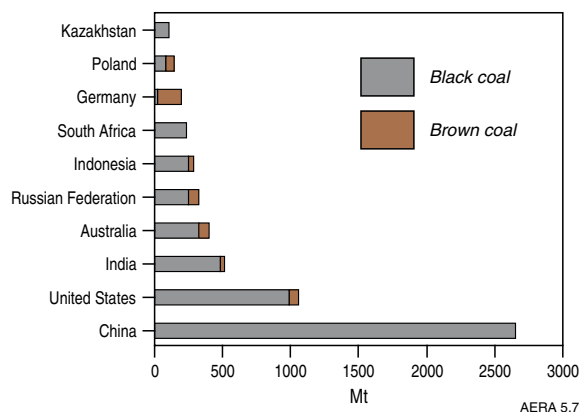


Figure 5.7 Black and brown coal production, major countries, 2008

Source: IEA 2009a

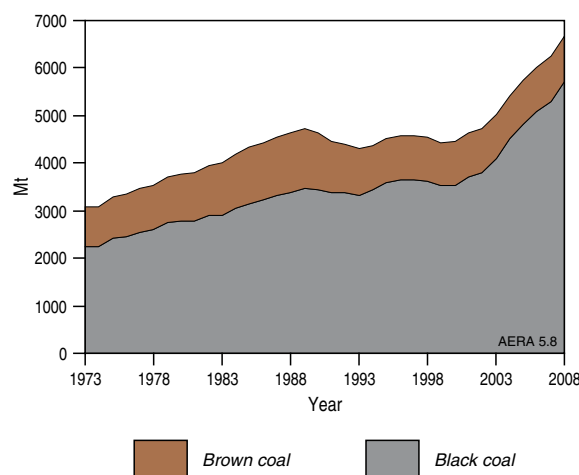


Figure 5.8 World production by coal type

Source: IEA 2009a

an average annual rate of 11 per cent since 2000 reflecting rapid expansions to its electricity generation and steel making capacity. The United States and India are also large coal consumers, accounting for around 15 per cent and 9 per cent of world consumption, respectively.

In the OECD, European coal consumption declined by a third between 1971 and 2008 as policies have encouraged the use of nuclear, gas and renewable energy fuels for electricity generation.

### Electricity generation

In 2007, electricity generation in China and the United States from coal-fired power plants was 2600 TWh and 2100 TWh, respectively (figure 5.12a). In China, coal accounts for around 80 per cent of electricity generation, while it is around 50 per cent in the United States (figure 5.12b). Other countries reliant on coal for over 90 per cent of their electricity generation are South Africa and Poland. Australia has a relatively high reliance on coal-fired electricity generation, at around 75 per cent in 2007–08.

Between 2000 and 2007, world coal-fired electricity generation increased by around 38 per cent to 8200 TWh. As a result, the share of coal-fired electricity generation increased from 38 per cent to 42 per cent of total electricity generation. The principal driver was China where coal-fired electricity

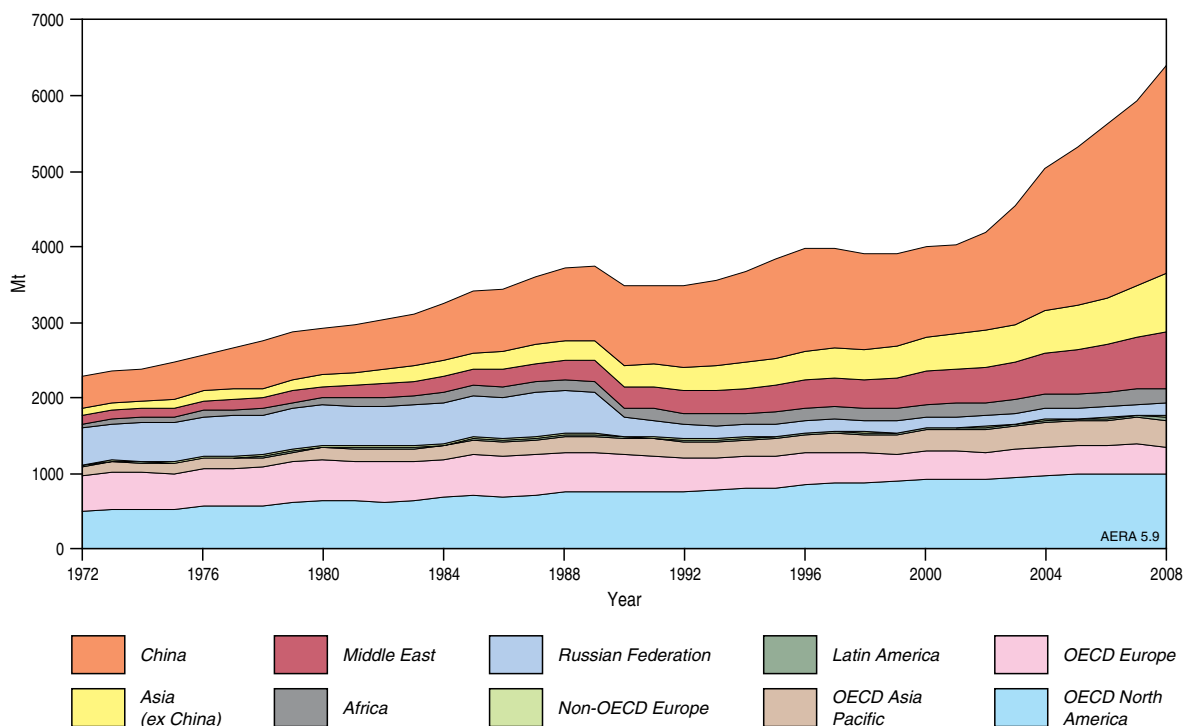
generation increased by 150 per cent between 2000 and 2007 (figure 5.13). Coal-fired generation capacity has also increased strongly in non-OECD Asia (excluding China) and OECD Asia Pacific (particularly Japan and the Republic of Korea).

### Trade

Around 14 per cent of world coal production is traded and almost all of it is black coal. Around 90 per cent of this trade is seaborne, with a small amount of coal traded via rail or truck.

Seaborne trade in thermal coal has increased on average by around 8 per cent per year and seaborne metallurgical coal trade has increased by nearly 3 per cent per year since 2000 (ABARE 2009d).

International trade in thermal coal is effectively divided into two regional markets: the Atlantic and Pacific markets. In the Pacific market the major importers include Japan, the Republic of Korea, Taiwan and China and the major exporters are Australia, Indonesia and the Russian Federation (from ports on its east coast). In the Atlantic market, major importers are in the European Union (notably the United Kingdom, Germany and Spain), the United States and north Africa. Supply is largely sourced from Colombia, South Africa, the Russian Federation and the United States. Thermal coal is generally not traded between the Atlantic and Pacific markets

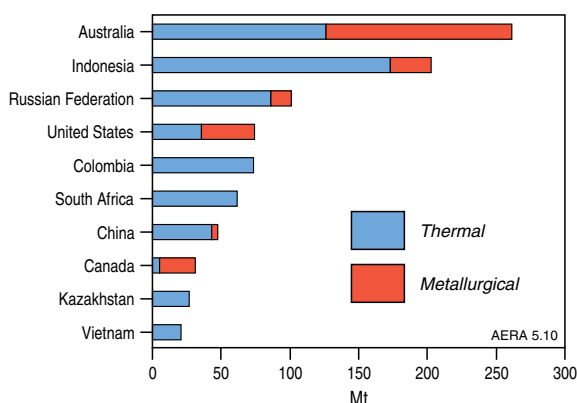


**Figure 5.9** Black coal consumption by region

**Note:** from 1971 to 1989, the USSR is counted as the Russian Federation. Black coal is used as most regions consume only small amounts of brown coal

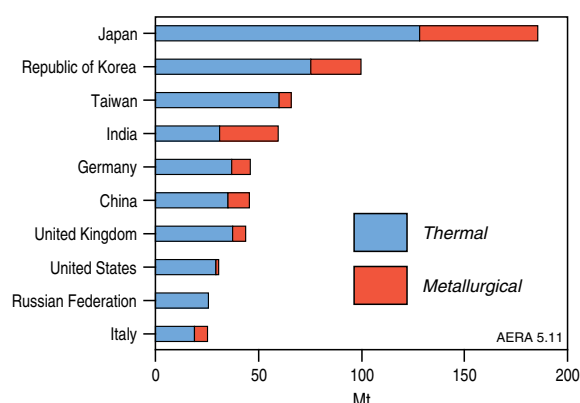
**Source:** IEA 2009a





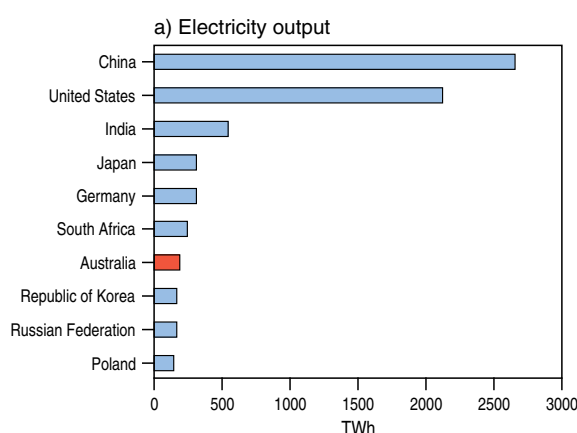
**Figure 5.10** Thermal and metallurgical coal exports, major countries, 2008

Source: IEA 2009a



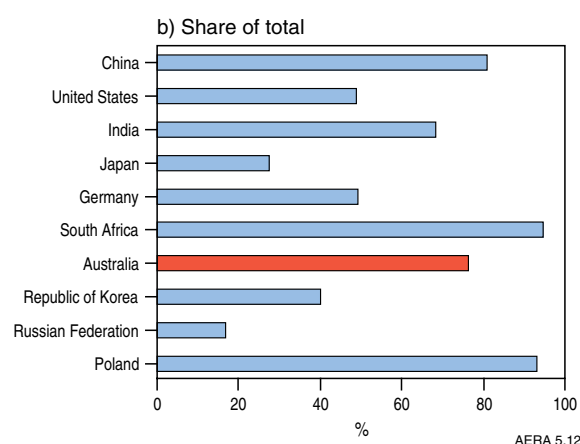
**Figure 5.11** Thermal and metallurgical coal imports, major countries, 2008

Source: IEA 2009a



**Figure 5.12** World electricity generation from coal, major countries, 2007

Source: IEA 2009b



because of the freight costs that increase with distance travelled.

Some metallurgical coal is traded across markets, most notably exports from Australia to Brazil and the European Union. This reflects Australia's position in the world metallurgical coal market, in which it accounts for almost 60 per cent of exports. The major metallurgical coal markets include Japan, the European Union, India and the Republic of Korea. After Australia, the main metallurgical coal exporters include the United States, Canada and the Russian Federation.

In 2008, Australia exported over 260 Mt of coal, making it the world's largest exporter (figure 5.10). Exports of metallurgical coal were 135 Mt and thermal coal 126 Mt. Australia is the world's largest exporter of metallurgical coal and the second largest exporter of thermal coal (ABARE 2009c). The world's largest exporter of thermal coal in 2008 was Indonesia, which exported around 173 Mt.

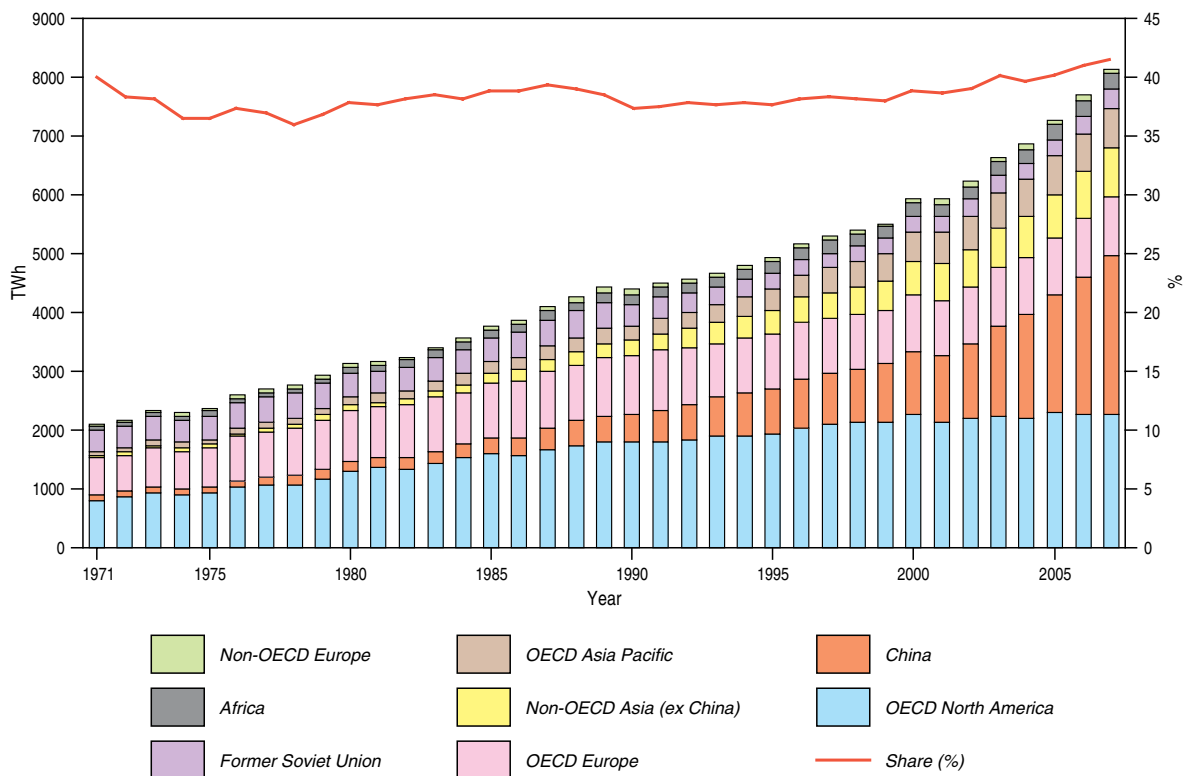
In 2008, the world's largest coal importer was Japan, importing 186 Mt, of which 128 Mt was thermal

coal and 57 Mt was metallurgical coal (figure 5.11). Japan's imports account for around 20 per cent of world imports. The Republic of Korea and Taiwan are also large coal importers, accounting for around 11 per cent and 7 per cent, respectively, of world coal imports.

### Outlook for world coal market to 2030

In its reference case, the IEA projects world coal demand to increase at an average annual rate of 1.9 per cent to 204 609 PJ in 2030 (table 5.3). Coal demand as a share of total energy demand is also projected to increase from 27 per cent in 2007 to 29 per cent in 2030. In the non-OECD, coal consumption growth is projected to be particularly strong at an average annual rate of 2.8 per cent. Much of the growth is anticipated to come from China and India where growth in electricity demand and steel production is expected to underpin coal consumption.

However, in the OECD coal demand is projected to decrease by around 5 per cent over the period 2007 to 2030. The outlook for coal consumption in the European Union is particularly weak – falling by 1 per cent per year – reflecting an increase in market



**Figure 5.13** World coal-fired electricity generation and coal's share of total electricity generation by region

Source: IEA 2009b

AERA 5.13

share of gas, nuclear and renewable energy in the electricity generation sector.

Global electricity generated from coal is projected to increase at an average annual rate of 2.7 per cent to 15 259 TWh in 2030 (table 5.4). However, coal's share of total electricity generation is projected to decline in the OECD. This reflects the increased competition from gas, nuclear and renewable sources, especially with the potential advent of policies to reduce emissions. However, coal-fired electricity generation is expected to grow the fastest in developing economies, where economic growth will require the expansion of electricity generation capacity.

**Table 5.3** IEA world outlook for coal demand, reference case

	unit	2007	2030
<b>OECD</b>	PJ	48 483	46 180
Share of total	%	36.4	22.6
Average annual growth	%	-	-0.2
<b>Non-OECD</b>	PJ	84 825	158 429
Share of total	%	63.6	77.4
Average annual growth	%	-	2.8
<b>World</b>	PJ	133 308	204 609
Share of total	%	100.0	100.0
Average annual growth	%	-	1.9

Source: IEA 2009c

Under the IEA's 450 scenario – predicated on countries taking collective action to limit global emissions to 450 ppm of CO<sub>2</sub> – the projected demand growth for energy is reduced from 1.5 per cent per year under the reference scenario to 0.8 per cent per year between 2007 and 2030. Demand for coal is significantly reduced compared with the reference scenario and, after reaching a plateau in 2015, coal demand is projected to decline to 2003 levels by 2030. Coal demand in 2030 would be about 47 per cent lower in 2030 than in the reference case, representing a decline of 0.9 per cent a year between 2007 and 2030 (IEA 2009c).

**Table 5.4** IEA world outlook for coal electricity generation, reference case

	unit	2007	2030
<b>OECD</b>	TWh	3947	4241
Share of total electricity generation	%	37.2	32.1
Average annual growth	%	-	0.3
<b>Non-OECD</b>	TWh	4258	11 019
Share of total electricity generation	%	41.6	52.3
Average annual growth	%	-	4.2
<b>World</b>	TWh	8216	15 259
Share of total electricity generation	%	41.6	44.5
Average annual growth	%	-	2.7

Source: IEA 2009c

## 5.3 Australia's coal resources and market

### 5.3.1 Coal resources

Coal occurs and is mined in all Australian states. Queensland and New South Wales have the largest black coal resources and production whereas Victoria hosts the largest resources and the only production of brown coal. Black coal has been mined in New South Wales for more than 200 years, while significant production of brown coal began in Victoria in 1920s. The most important black coals range in age from Permian to Jurassic (from about 280 to 150 million years ago) but the major resources are of Permian age. Australia's major deposits of brown coal are of Tertiary age (50–15 million years).

Australia's principal black coal producing basins are the Bowen (Queensland) and Sydney (New South Wales) Basins. The Permian coal measures in the Bowen Basin outcrop or lie beneath a thin cover of younger sediments over an area of some 120 000 km<sup>2</sup>. Both metallurgical and thermal coals occur in numerous coal-bearing sequences throughout the basin.

Other basins with significant coal resources in Queensland include the Permian-aged Galilee Basin which lies to the west of the Bowen Basin and covers an area of some 200 000 km<sup>2</sup>. There has been no production to date but the Galilee Basin is emerging as an area of considerable exploration interest for thermal coal and is estimated to contain some 6 Gt of coal. The southern half of the Bowen Basin is overlain by the Jurassic-Cretaceous sediments of the broad intra-cratonic Surat Basin which covers an area of 270 000 km<sup>2</sup> in Queensland and New South Wales. The Surat Basin contains the Jurassic Walloon Coal Measures which are a source of thermal coal and, more recently, coal seam gas. Similarly, the Jurassic coals of the Clarence-Moreton Basin and the Triassic coals of the Ipswich Basin have provided coal for electricity generation and industrial uses in the Brisbane region and for export. Other coal basins in Queensland include: Styx (Cretaceous), Mulgildie (Jurassic), Maryborough (Cretaceous), Tarong (Triassic) and Laura (Jurassic).

The Sydney Basin is approximately 350 km long, has an average of width of 100 km, and covers some 35 000 km<sup>2</sup>. The Sydney Basin is geologically contemporaneous with the Bowen Basin but, unlike the Bowen Basin, the Sydney Basin coal sequences are

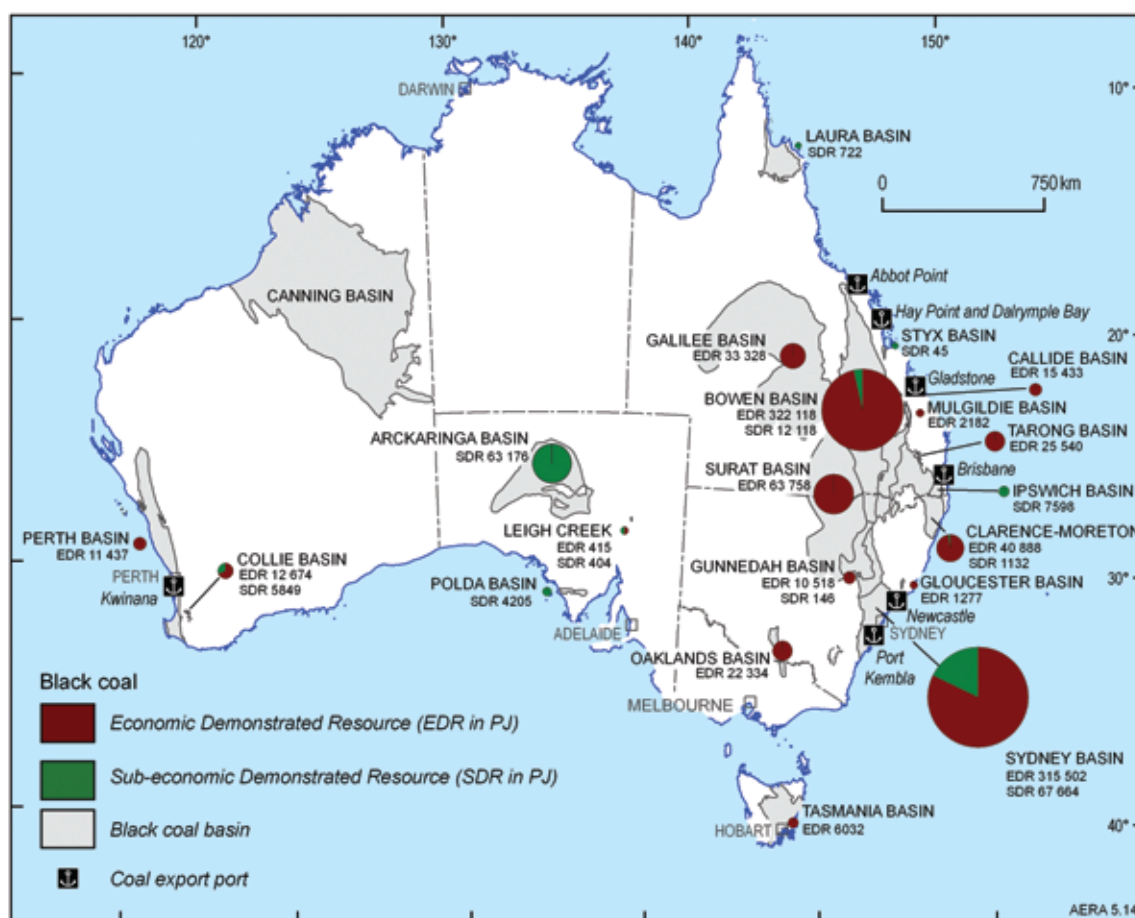


Figure 5.14 Black coal resources in Australia

Source: Geoscience Australia

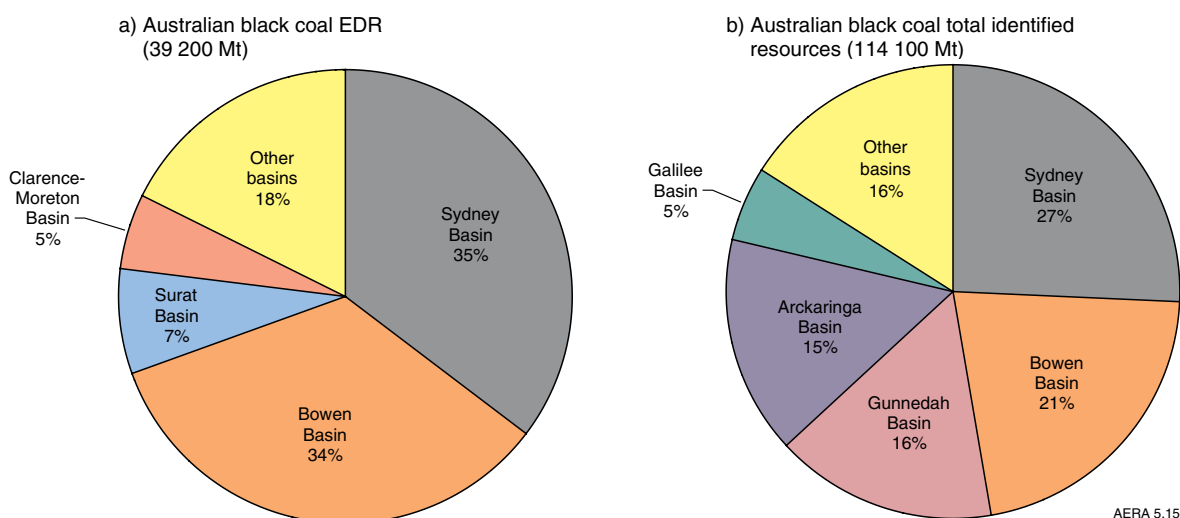
overlain by a thicker and more continuously preserved cover of Triassic sediments. As a consequence, development of coal resources has concentrated on coal deposits near the basin margins where the cover is thinner. The Sydney Basin passes to the north into the Gunnedah Basin, which covers some 15 000 km<sup>2</sup> and comprises rocks of Permian and Triassic age and is estimated to contain more than 18 Gt of coal (both metallurgical and thermal).

The Triassic-Jurassic age coals in the Clarence-Moreton Basin in New South Wales are not mined. Thermal coal is produced from the small (3000 km<sup>2</sup>) Gloucester Basin to the north of Newcastle. Substantial thermal coal resources are known to occur in the Permian Coorabin Coal Measures of the Oaklands Basin in the Riverina District of New South Wales.

The sub-bituminous coal measures of Permian age in the Collie Basin in Western Australia are mined for electricity generation. In South Australia, sub-bituminous Triassic coal measures at Leigh Creek

are mined for electricity generation. Major resources of sub-bituminous coal of Permian age occur in the Arckaringa Basin in central South Australia. The black coal measures in the Tasmania Basin are of sub-bituminous rank and Triassic in age.

Australia's brown coal resources are of Tertiary age and are dominated by those in the Gippsland Basin in Victoria where coal is mined to generate electricity. Significant brown coal resources are also found in the Otway Basin in Victoria where they are used to produce electricity at Anglesea. Large brown coal resources are also known to occur in the Murray Basin in western Victoria and South Australia, and in the North St Vincents Basin in South Australia. Brown coal resources have been discovered in Western Australia in the Eucla Basin (e.g. Balladonia) and in the onshore part of the Bremer Basin (e.g. Scaddan). Minor brown coal resources occur in Tasmania in the Longford Basin and an occurrence of brown coal is known in Queensland at Waterpark Creek north of Yeppoon.



**Figure 5.15** Australia's black coal resources by major basin, 2008

**Source:** Geoscience Australia

**Table 5.5** Australia's recoverable black and brown coal resources, December 2008

Recoverable Resources	Black Coal (Mt)	Black Coal (PJ) <sup>a</sup>	JORC Reserves (Mt)
Economic	39 200	883 400	13 400
Sub-economic	8 300	163 100	-
Inferred	66 600	1 468 900	-
<b>Black Coal Total</b>	<b>114 100</b>	<b>2 515 400</b>	<b>13 400</b>
	Brown Coal (Mt)	Brown Coal (PJ)	JORC Reserves <sup>b</sup> (Mt)
Economic	37 200	362 000	4800
Sub-economic	55 100	534 300	-
Inferred	101 800	990 300	-
<b>Brown Coal Total</b>	<b>194 000</b>	<b>1 886 600</b>	<b>4800</b>
<b>Coal Total</b>	<b>308 100</b>	<b>4 402 000</b>	<b>18 200</b>

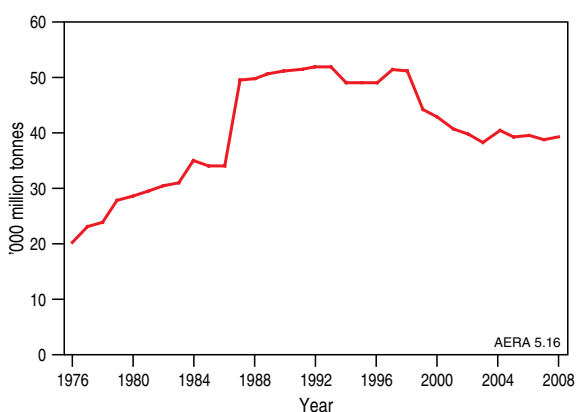
**a** Includes estimates where operating mines have no JORC reserves. **b** No brown coal JORC Reserves are available (Geoscience Australia estimate)

**Source:** Geoscience Australia 2009

Australia's coal resources are published under the McKelvey classification of Economic and Sub-economic Demonstrated Resources and Inferred Resources used by Geoscience Australia (table 5.5; Appendix D). JORC (industry) reserves are also shown to provide information on the proportion of Australia's EDR that is currently considered commercially viable by privately owned companies.

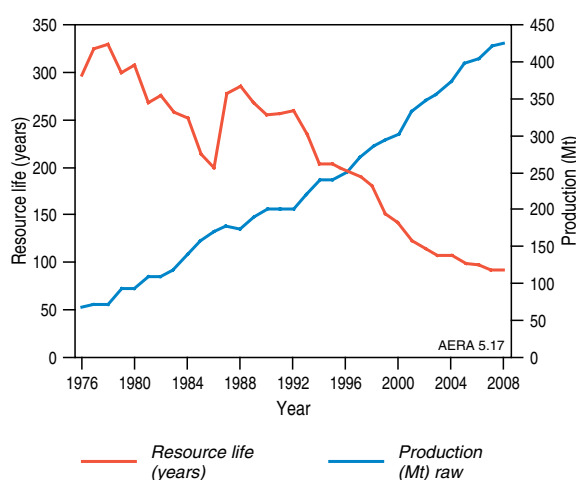
### Black coal

Recoverable economic demonstrated resources (EDR) of black coal in 2008 were estimated at 39.2 Gt with Queensland (56 per cent) and New South Wales (40 per cent) having the largest shares (figure 5.14). The Sydney Basin (35 per cent) and Bowen Basin (34 per cent) contain most of Australia's recoverable EDR of coal on both a tonnage and energy basis. These world-class coal basins contain nearly half of Australia's black coal total resources and dominate production. There are also significant black coal EDR in the Surat, Galilee and Clarence-Moreton basins (figures 5.14 and 5.15). Effectively all black coal EDR is accessible.



**Figure 5.16** Black coal economic demonstrated resources, 1976 to 2008

Source: Geoscience Australia



**Figure 5.17** Black coal resource life and production, 1976 to 2008

Source: Geoscience Australia

The resource life of the EDR of 39.2 Gt is about 90 years at current rates of production. The black coal JORC reserves are 13.4 Gt or 34 per cent of EDR. Included in the 13.4 Gt are Geoscience Australia estimates of reserves at some operating mines for which no JORC reserves have been reported. This constituted 1.9 Gt or about 14 per cent of JORC reserves. BHP Billiton, Rio Tinto and Xstrata Coal manage about 57 per cent of JORC reserves in Australia. The resource life of the JORC reserves of 13.4 Gt is 31 years at current rates of production.

Australia also has some 8.3 Gt of sub-economic black coal resources, mostly within the Sydney and Arckaringa basins. In addition there are very substantial inferred black coal resources – about 66.6 Gt, almost double the current EDR of black coal – lying mostly in the Gunnedah, Arckaringa, Sydney, and Bowen basins (table 5.6). Renewed exploration interest in the past decade has resulted in a significant increase in inferred coal resources, notably in the Gunnedah and Galilee Basins.

**Table 5.6** Recoverable black coal resources by basin as at 31 December 2008

Category	Basin	Mt	PJ
EDR	Sydney	13 800	315 500
EDR	Bowen	13 400	322 100
EDR	Surat	2900	63 800
EDR	Clarence-Moreton	2000	40 900
EDR	Galilee	1700	33 300
EDR	Other	5400	107 900
<b>Total EDR</b>		<b>39 200</b>	<b>883 400</b>
SDR	Sydney	3000	67 700
SDR	Bowen	500	12 100
SDR	Ipswich	340	7600
SDR	Collie	300	5800
SDR	Arckaringa	3800	63 200
SDR	Other	360	6700
<b>Total SDR</b>		<b>8300</b>	<b>163 100</b>
INF	Sydney	12 600	286 600
INF	Bowen	10 600	253 400
INF	Galilee	4500	89 700
INF	Gunnedah	17 700	461 300
INF	Arckaringa	13 900	233 400
INF	Other	7300	144 500
<b>Total INF</b>		<b>66 600</b>	<b>1 468 900</b>
<b>Total EDR + SDR + INF</b>		<b>114 100</b>	<b>2 515 400</b>

Source: Geoscience Australia

The changes in Australia's black coal resources with time are shown in figure 5.16. The steep increase in EDR in 1987 is due to a major reassessment of New South Wales coal resources in 1986 by the then New South Wales Department of Mineral Resources and the Joint Coal Board. The decline in EDR since 1998 results from industry re-estimating reserves and mineral resources more conservatively in order to comply with the requirements of the JORC Code as well as increased mine production.

Major increases in production over the past 40 years has seen the resource life of Australia's black coal resources fall from about 300 years to around 90 years (figure 5.17).

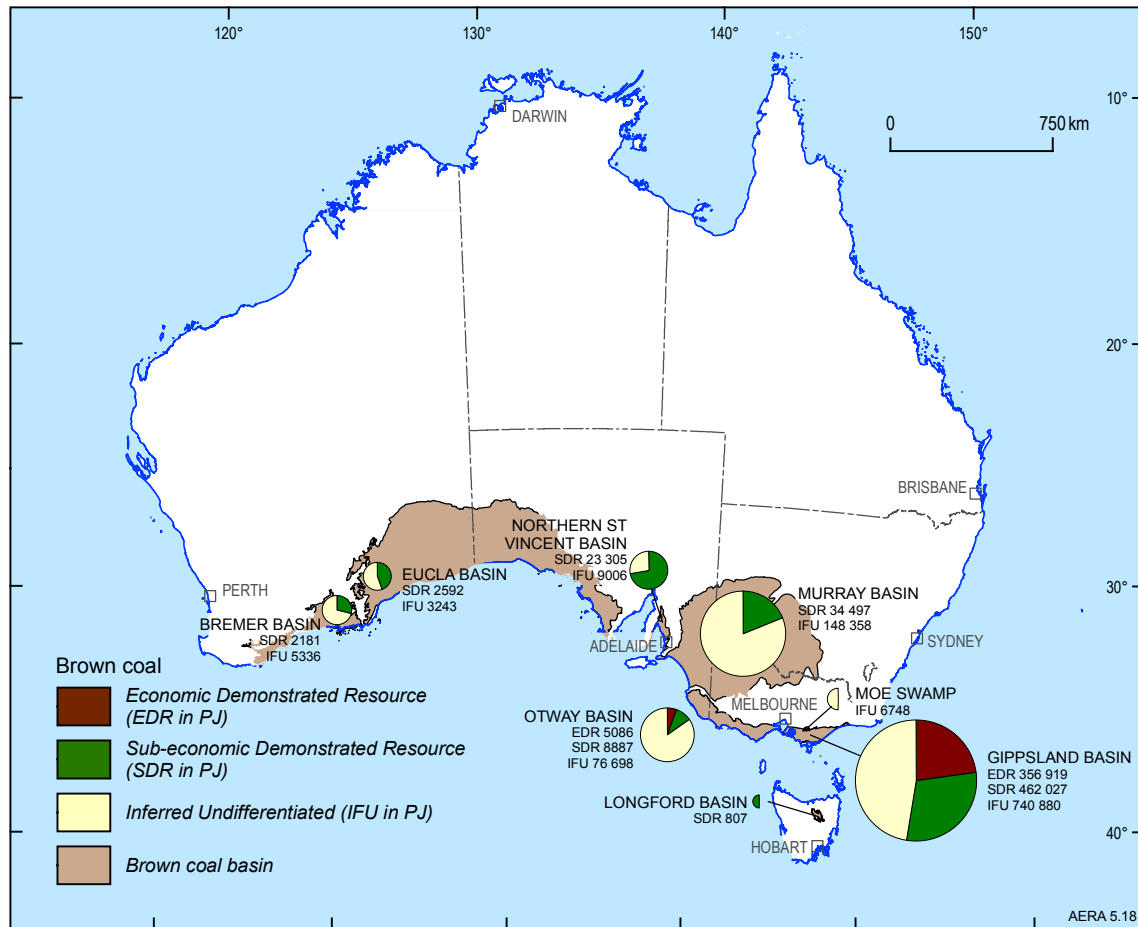
### Brown coal

Recoverable EDR of brown coal for 2008 were estimated to be 37.2 Gt, all located in Victoria and about 93 per cent of the total EDR is in the La Trobe Valley (figure 5.18). The Gippsland Basin contains 99 per cent of the total recoverable brown coal EDR of Australia. Approximately 86 per cent of brown coal EDR is accessible. Quarantined resources include the APM Mill site that has a 50 year mining ban that commenced in 1980 and coal that is under the Morwell township and the Holey Plains State Park.

**Table 5.7** Recoverable brown coal resources by basin as at 31 December 2008

Category	Basin	Mt	PJ
EDR	Gippsland	36 800	356 900
EDR	Otway	400	5100
EDR	Murray	0	0
EDR	Other	0	0
<b>Total EDR</b>		<b>37 200</b>	<b>362 000</b>
SDR	Gippsland	47 600	462 000
SDR	Otway	800	8900
SDR	Murray	3500	34 500
SDR	Other	3200	28 900
<b>Total SDR</b>		<b>55 100</b>	<b>534 300</b>
INF	Gippsland	76 400	740 900
INF	Otway	7300	76 700
INF	Murray	15 300	148 400
INF	Other	2800	24 300
<b>Total INF</b>		<b>101 800</b>	<b>990 300</b>
<b>Total EDR + SDR + INF</b>		<b>194 100</b>	<b>1 886 600</b>

Source: Geoscience Australia



**Figure 5.18** Brown coal resources in Australia

Source: Geoscience Australia



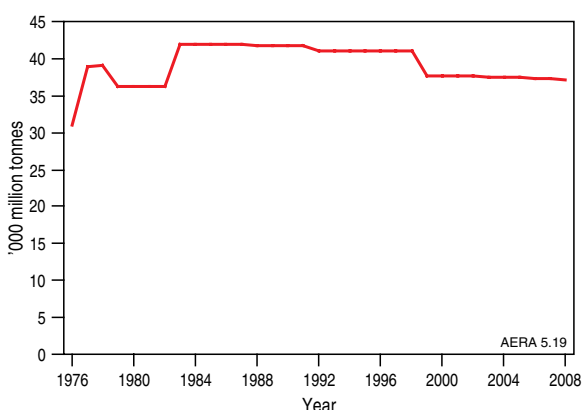
The resource life of accessible EDR of 32.2 Gt is about 490 years. JORC reserve estimates are not available for brown coal resources. Geoscience Australia estimates from published information that the reserves at operating mines are about 4.8 Gt, and have a resource life of about 70 years.

In addition to the EDR of brown coal there are larger sub-economic brown coal resources in the Gippsland Basin, and even larger inferred resources of brown coal, predominantly contained in the Gippsland, Murray and Otway basins (figure 5.18; table 5.7).

Australia's EDR of brown coal have remained relatively constant since 1976 (figure 5.19). A doubling of production over the past 40 years has resulted in a halving of the resource life to around 490 years.

### Coal exploration

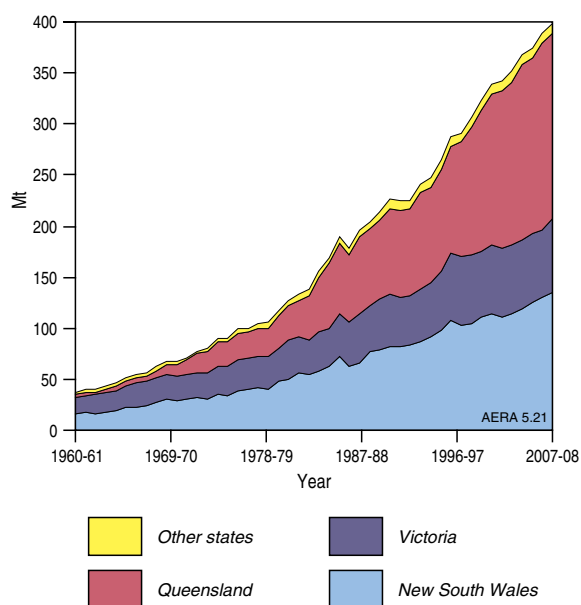
Australia is currently experiencing record levels of coal exploration. Data published by the Australian Bureau of Statistics (ABS 2009) show that over the



**Figure 5.19** Brown coal economic demonstrated resources, 1976 to 2008

Source: Geoscience Australia

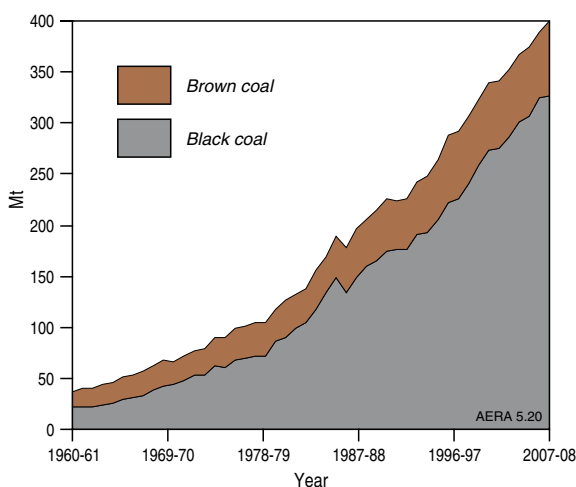
past five years annual coal exploration expenditure has increased from \$84.7 million to \$276.3 million in 2008. The bulk of the exploration is focussed in Queensland (59 per cent) and New South Wales (34 per cent of the total) in 2008. The remaining expenditure occurred in South Australia, Western Australia, Tasmania and Victoria. In 2008 coal exploration expenditure contributed 10.6 per cent to the total mineral exploration expenditure in Australia. The last sustained period of high levels of coal exploration was during the early 1980s in response to world energy shocks and a broadly based resources boom and coincided with the major expansion of Australia's coal resources, particularly those in the Bowen Basin.



**Figure 5.21** Production of saleable coal by state

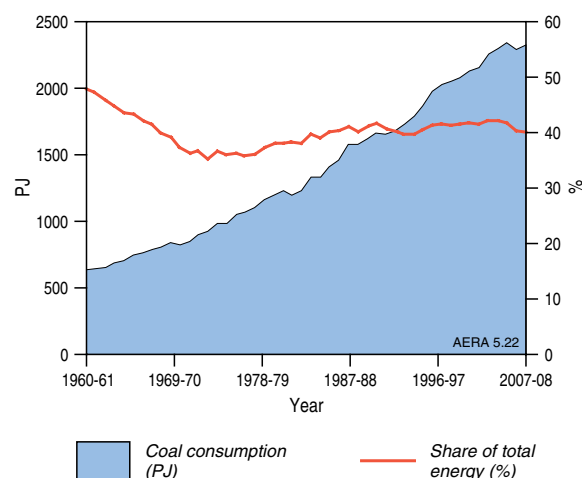
Note: Victoria is brown coal and the other states black coal

Source: ABARE 2009d



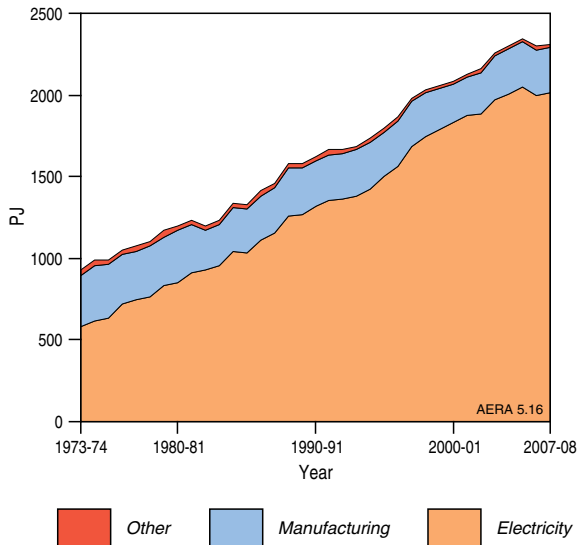
**Figure 5.20** Australia's production of saleable black and brown coal

Source: ABARE 2009d

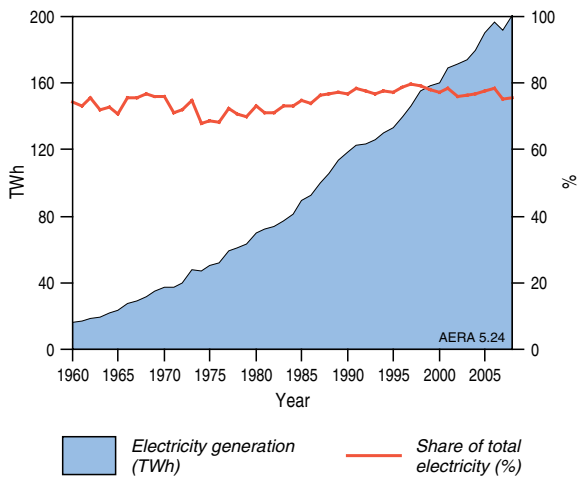


**Figure 5.22** Australian coal consumption and share of total primary energy

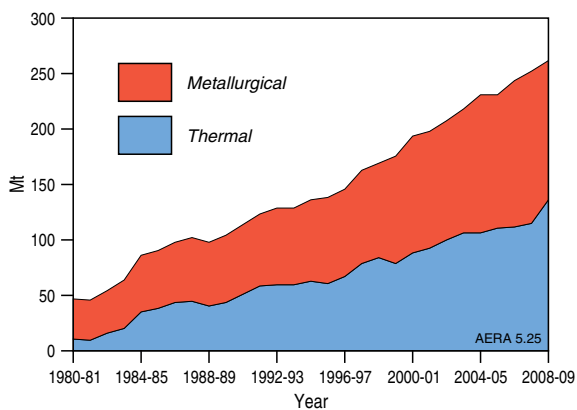
Source: ABARE 2009a



**Figure 5.23** Australian coal consumption by sector  
**Source:** ABARE 2009a



**Figure 5.24** Australian use and share of coal in thermal electricity generation  
**Source:** IEA 2009b



**Figure 5.25** Australia's exports of thermal and metallurgical coal  
**Source:** ABARE 2009d

### 5.3.2 Coal market

#### Production

Australia's combined production of saleable black and brown of coal is shown in figure 5.20. Raw coal production in 2007–08 was estimated to be around 487 Mt (9431 PJ) which represents an average annual increase of 5 per cent from 1960–61. Black coal accounted for 86 per cent or 421 Mt (8722 PJ). Queensland and New South Wales accounted for the majority of this production: 57 per cent and 41 per cent respectively.

Brown coal production in 2007–08 was estimated to be around 67 Mt (709 PJ), all from Victoria.

Figure 5.21 shows the breakdown of coal production by state. The majority of Queensland's coal production is in the Bowen Basin, around 150–200 km inland from the towns of Mackay and Gladstone. There are also a number of mines in the Clarence-Moreton Basin, around 50–100 km west of Brisbane, and in the Tarong, Callide and Surat Basins.

In New South Wales, the majority of coal production is in the Hunter Valley, extending 30–100 km northwest of Newcastle. There are also a number of mines in the Gunnedah Basin (200 km northwest of Newcastle) and mines to the immediate south and west of Sydney. Relatively small amounts of coal are also produced in South Australia, Western Australia and Tasmania.

#### Primary energy consumption

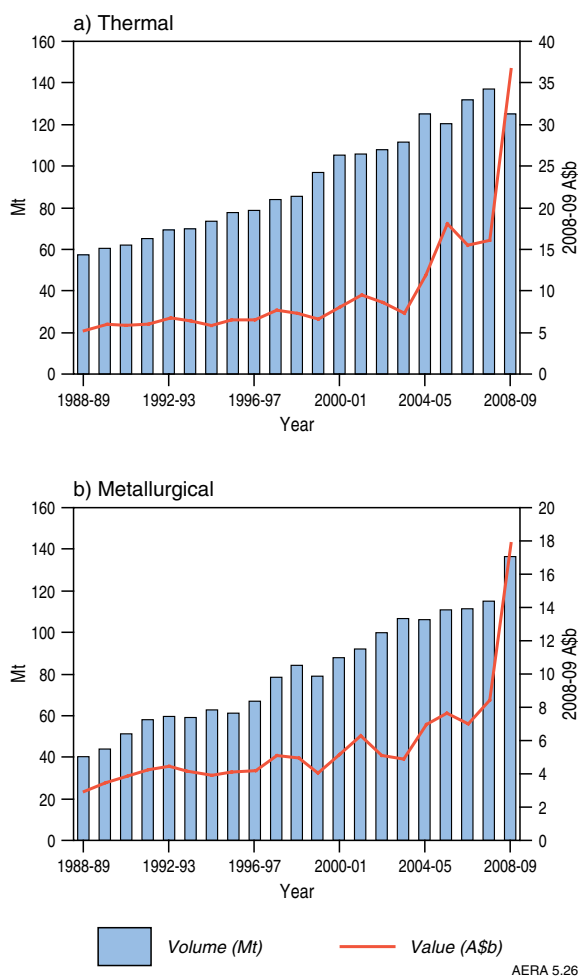
In 2007–08, Australia's coal consumption was around 2292 PJ (135 Mt). Since 1960–61, Australia's coal consumption has increased at an average annual rate of 5 per cent (figure 5.22). The increase in consumption (figure 5.23) reflects increased demand for electricity associated with economic and population growth. Much of this increased electricity demand has been met through coal-fired generation.

#### Electricity generation

In 2007–08, around 75 per cent of Australia's electricity was generated from coal. Coal's share of electricity generation has ranged between 60 and 80 per cent since the 1960s (figure 5.24). The use of coal for electricity generation reflects its low cost relative to other fuels and the large resource base which is located close to electricity demand centres in south eastern Australia. Ready availability of low cost coal has underpinned relatively low cost electricity (by global standards) in mainland Australia.

#### Trade

In 2008–09, Australia exported around 65 per cent of its saleable black coal production. All brown coal production was consumed domestically. The majority of Australia's exported coal is produced in New South Wales and Queensland. Recently small amounts of coal



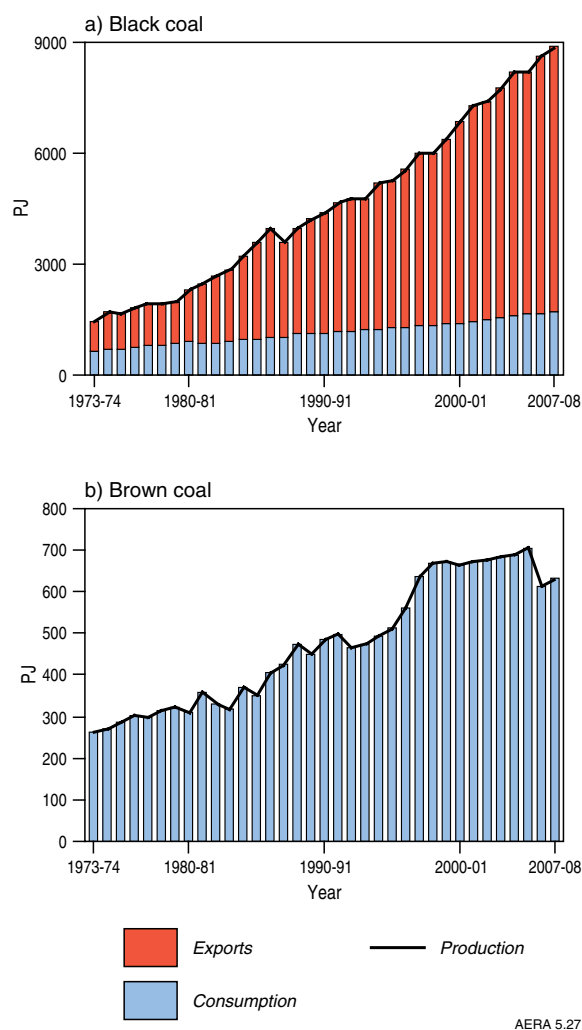
**Figure 5.26** Australia's export volume and value of thermal and metallurgical coal

Source: ABARE 2009d

have been exported from Kwinana in Western Australia. Newcastle is the largest port and in 2008–09, coal exports from Newcastle totalled around 100 Mt.

In 2008–09, Australia exported around 261 Mt of coal – 135 Mt of metallurgical coal and 126 Mt of thermal coal (figure 5.25). Australia's major export markets for metallurgical coal are Japan, India, the European Union, the Republic of Korea and Taiwan. Japan, the Republic of Korea and Taiwan are Australia's major export markets for thermal coal. Coal exports have increased over the past 30 years underpinned by strong growth in demand from these major trading partners.

The value of Australia's coal exports in 2008–09 was a record \$55 billion, an increase of 130 per cent from 2007–08. The value of thermal coal exports increased by 130 per cent to \$37 billion and metallurgical coal exports increased 125 per cent to \$18 billion (figure 5.26). The significant increase in export values, in part, reflects record contract prices for Japanese



**Figure 5.27** Australia's exports and consumption of black and brown coal

Source: ABARE 2009a

Fiscal Year (JFY) 2008 (April 2008–March 2009), when coal prices more than doubled. With contract prices for JFY 2009 having been settled at considerably lower levels, export earnings for 2009–10 are expected to recede from these record levels.

### Supply-demand balance

Australia's black coal production has significantly exceeded domestic consumption and the surplus has been sold into international markets (figure 5.27a). Growing global demand for both good quality thermal and metallurgical coal has led to increased coal production and exports. Australia's substantial high quality coal resources and reputation as a country with low sovereign and security risks has encouraged important investments in the coal industry by consumers in major import markets such as Japan, the Republic of Korea, and increasingly China.

In contrast, all of Australia's brown coal production is consumed domestically (figure 5.27b). Production is

**Table 5.8** Coal mining projects recently completed, as at October 2009

Project	Location	Start up	Capacity	Capital Expenditure
Lake Lindsay	Qld	2009	4 Mt coking and thermal	US\$726 m
Abel underground	NSW	2008	4.5 Mt ROM semi-soft coking and thermal	\$84 m
Dawson project	Qld	2008	5.7 Mt coking and thermal	\$1.1 b
Glendell opencut	NSW	2008	2 Mt thermal	\$123 m
Rocglen (Belmont) opencut	NSW	2008	1.5 Mt thermal	\$35 m
Sonoma coal project	Qld	2008	1.8 Mt coking and 0.2 Mt thermal	\$200 m
Vermont Coal Project	Qld	2008	4 Mt coking	\$264 m
Ashton longwall	NSW	2007	3 Mt coking and thermal	\$150 m
Boggabri opencut	NSW	2007	1.5 Mt thermal	\$35 m
Curragh North	Qld	2007	2.4 Mt coking	\$360 m
Ensham Central	Qld	2007	3 Mt thermal	\$100 m
Isaac Plains	Qld	2007	1.6 Mt coking	\$66 m
Kogan Creek opencut	Qld	2007	2.8 Mt thermal	\$80 m
New Acland opencut	Qld	2007	1.5 Mt thermal	\$60 m
Newpac longwall	NSW	2007	4 Mt coking	\$75 m
North Wambo longwall	NSW	2007	3 Mt thermal	\$101 m
Poitrel	Qld	2007	3 Mt coking	\$330 m
Wilkie Creek	Qld	2007	0.6 Mt thermal	\$15 m
Tarawonga opencut	NSW	2007	1.3 Mt thermal	\$38 m
Wilpinjong opencut	NSW	2007	3 Mt thermal	\$123 m

Source: ABARE 2009e

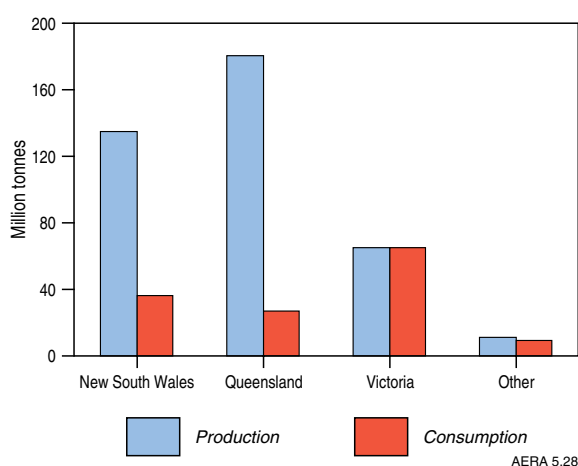
**Table 5.9** Coal infrastructure projects recently completed, as at October 2009

Project	Location	Start up	Capacity increase	Capital Expenditure
Abbot Point Coal Terminal X21 expansion	Qld	2007	6 Mtpa (new capacity 21 Mtpa)	\$116 m
Blackwater to Burngrove duplication (rail)	Qld	2007	na	\$43 m
Bluff to Blackwater Duplication (rail)	Qld	2007	na	\$58.5 m
Hay Point Coal Terminal Phase 2	Qld	2007	4 Mtpa (new capacity 44 Mtpa)	\$70 m
Kooragang Island Coal Terminal	NSW	2007	16 Mtpa (new capacity 80 Mtpa)	\$170 m
Broadlea to Wotonga duplication (rail)	Qld	2008	na	\$70 m
Callemondah to RG Tanna (rail)	Qld	2008	na	\$40 m
Dalrymple Bay Coal Terminal 7X expansion Phase 1	Qld	2008	8 Mtpa (new capacity 68 Mtpa)	\$530 m
RG Tanna Coal Terminal expansion	Qld	2008	28 Mtpa (new capacity 68 Mtpa)	\$800 m
Abbot Point Coal Terminal X25 expansion	Qld	2009	na	\$95 m
Dalrymple Bay Coal Terminal 7X expansion project Phase 2/3	Qld	2009	17 Mtpa (new capacity 85 Mtpa)	\$679 m
Grantleigh to Tunnel (rail)	Qld	2009	na	\$49 m
Jilalan Rail Yard Upgrade	Qld	2009	na	\$500 m
Stanwell -Wycarbah upgrade (rail)	Qld	2009	na	\$72 m
Vermont Rail Spur and Balloon Loop	Qld	2009	na	\$70 m

Source: ABARE 2009e

closely matched to consumption at adjacent power stations, a link sometimes referred to as 'mine-mouth power generation'. After growing strongly during the early 1990s and then levelling off in the first half of the 2000s, brown coal production has fallen in recent years. The decline reflects competition from other fuels in Victoria, particularly gas.

The majority of Australia's coal consumption occurs in New South Wales, Queensland and Victoria (figure 5.28). In terms of tonnage, Victoria is responsible for just under half of Australia's coal consumption. However, in energy terms, New South Wales and Queensland account for nearly 70 per cent. The difference between weight and energy content across the states reflects the low rank of coal used in Victoria, where a tonne of coal contains around a third of the energy content of that consumed in New South Wales and Queensland.



**Figure 5.28** Production and consumption of saleable coal by state, 2007–08

**Note:** Victoria produces and consumes only brown coal. All other states produce and consume black coal

**Source:** ABARE 2009d

### Major development projects recently completed

The recent completion of numerous coal mine and infrastructure projects has underpinned the expansion of Australia's coal exports. Over the past three years, 20 mine projects have been completed with a production capacity of 54 Mt and an estimated capital expenditure of over \$4.3 billion (table 5.8).

Coal infrastructure projects (essentially upgrades and expansions of port and rail facilities) completed over the past three years are shown in table 5.9. These projects, at an estimated capital cost of \$3.4 billion, have increased rail and port capacity by around 80 Mt per year. The expansion in mine and infrastructure capacity has been necessary to support the increase of Australia's coal exports from 233 Mt in 2005 to an estimated 260 Mt in 2009.

## 5.4 Outlook to 2030 for Australia's resources and market

The key messages from the outlook to 2030 are:

- Australia's coal production is projected to increase at an average annual rate of 1.8 per cent to about 13 875 PJ in 2029–30.
- Growth will be in increased exports which are projected to increase by 2.4 per cent per year to 2029–30.
- Domestic coal consumption is projected to decrease at an average annual rate of 0.8 per cent to 1763 PJ in 2029–30.
- Coal's share of domestic electricity generation is projected to decline from around 75 per cent in 2007–08 to 43 per cent in 2029–30.
- Gas and renewable energy sources (especially wind) are projected to make a greater contribution to electricity generation.
- The development of cost-effective lower emissions coal technologies, notably carbon capture and storage, will be critical to maintaining coal's position in electricity generation.
- Future growth of Australia's coal production and exports depend on global economic growth, carbon reduction policies, coal prices, adequacy of coal handling infrastructure, and local water and environmental issues.

### 5.4.1 Key factors influencing the outlook

The key factors influencing the future development of Australia's coal industry include:

- Global economic growth and demand for coal are projected to maintain coal's position as the fastest-growing energy source except for some renewable energy sources. Under the IEA reference scenario coal is projected to grow at an annual rate of 1.9 per cent to 2030 (IEA 2009c).
- Most (97 per cent) of the projected growth in demand is expected to come from non-OECD countries, mostly in Asia. More than 75 per cent of the increase is expected to be for thermal coal for power generation.
- Australia's ability to meet the increased demand for coal exports will require matching expansion of coal infrastructure, including rail and port (coal loading) capacity.
- Global growth in coal demand is likely to be influenced by global policies on carbon emissions.
- Domestic coal consumption and coal's share of electricity generation is projected to decline from its current very high level (75 per cent) as a consequence of policies to decrease national

greenhouse emissions, including the Renewable Energy Target and emission reduction targets that will encourage growth of renewable and other lower-emissions energy sources.

- Coal-fired electricity generation will be replaced by gas and, to a lesser extent, renewable energy.
- The future position of coal in electricity generation will be strongly influenced by the cost of electricity production from renewable energy sources

compared with the cost of new low-emission coal technologies.

- Government and industry initiatives such as the Global Carbon Capture Storage Institute, the Carbon Capture Storage Flagships program, and the Coal21 program are likely to play an important role in the development and commercial deployment of new low-emission technologies in the outlook period.

### BOX 5.1 EVOLUTION OF FLEXIBLE PRICING IN COAL MARKETS

Historically, seaborne trade of thermal coal has operated under long-term contracts which provide security for both suppliers and consumers. Contract terms defined the annual quantities to be purchased, including buyer and seller options as well as fixed prices for each year. Contracts usually contained a provision for price changes proportionate to changes in input cost indices. By the 1990s, a trend toward long-term contracts with annual price review became more common. These new contract arrangements allowed prices to be revised through annual negotiation of a benchmark price or through the use of spot price indices. The shift toward provisions for an annual price change in coal contracts reflected coal suppliers' and consumers' preferences for security while also ensuring prices reflected market fundamentals.

As trade in thermal coal has increased over the past 30 years, so has the proportion of trade occurring on spot markets. In 1990, Australian thermal coal sold on spot markets is estimated to have accounted for around 17 per cent of total trade. By 2007, this proportion is estimated to have increased to 30 per cent. Although long-term contracts still play a major role in the thermal coal market, spot sales have increased in importance.

Thermal coal sold on spot markets is subject to contracts which have a similar content to long-term contracts but cover a much shorter timeframe. Similar to long-term contracts, spot contracts specify agreement on each party's rights and obligations in the loading, travel, delivery, testing, weighing and rejection processes. Spot sales may be for a single cargo, part cargoes or for a series of cargoes. Spot coal transactions can occur in a variety of forums including established trading platforms such as globalCOAL, through traders or between producers and consumers.

Trading of coal as a commodity on spot markets has been further enhanced by the introduction of a number of coal indices that define and standardise provenance, quality, place of delivery as well as other conditions. The Barlow Jonker Index (BJI), the McCloskey Newcastle FOB and the globalCOAL index are examples of major indicators of the spot market price in the Asia Pacific market.

A significant change to the thermal coal market occurred in 2000 with the deregulation of the European electricity market. Deregulation removed the past certainty afforded by fixed coal and electricity prices and introduced competition between power generators for market share, resulting in volatility in both electricity and thermal coal prices. As a consequence, EU power generators have shifted their coal purchases from fixed long-term contracts to a spot basis.

The majority of seaborne metallurgical coal imports to Japan, the Republic of Korea and the European Union, still occur under long term contracts with annual price negotiations. The move towards flexible pricing has been much slower compared with changes in the thermal coal market. This is a result of two factors. Firstly, steel mills in Japan and the European Union place significant value on sourcing coal from particular mines, which limits their ability to purchase large proportions of coal requirements from the spot market. In turn this limits the size of the coking coal spot market which makes calculating an accurate price index more complicated. The preference of a number of Japanese and European steel mills to purchase coal from specific mines reflects the set up of blast furnaces which are designed to burn a very specific blend. Secondly, a number of steel mills receive annually fixed prices for their steel and hence prefer the stability of fixed input prices.

Over the next 20 years, Chinese and Indian steel mills are expected to increase their share of metallurgical coal imports. Generally, Chinese and Indian steel mills have greater flexibility in the coal blend they can use and hence would be more willing to purchase a coal via a spot or tender process. In China, variations in domestic metallurgical coal production mean that import requirements may change from year to year making it difficult for Chinese steel mills to commit to large tonnage, long term agreements. These factors may support an increase in metallurgical coal spot trade which in turn could increase the liquidity of a spot market and enable the development of metallurgical coal spot indices.

**Source:** Metal Bulletin 2008; Ekawan et al. 2006



### Global growth and demand for coal

In the IEA reference scenario, world electricity demand is expected to grow at an annual rate of 2.4 per cent to 2030 and underpin strong demand for coal, maintaining its position as the fastest-growing energy source except for some renewable energy sources. Coal demand is expected to grow at an annual rate of 1.9 per cent in the period to 2030. Most (97 per cent) of the projected growth in demand is expected to come from non-OECD countries, notably those in Asia. Coal consumption in OECD countries is projected to fall at an annual rate of 0.2 per cent to 2030, continuing a long-term decline in the OECD share of global coal consumption. More than 75 per cent of the increase in global coal consumption is expected to be for thermal coal for power generation with the bulk of demand growth from China and India (IEA 2009c).

In the IEA's 450 scenario global coal demand declines by 0.9 per cent a year to 2030 and is 47 per cent lower in 2030 than under the reference scenario (IEA 2009c). This reduced global coal demand is expected to flow through to reduced production by exporting countries with almost three-quarters of the reduction in production borne by non-OECD countries. Global coal trade is expected to continue to grow even under the 450 scenario but is projected to be 53 per cent below the reference scenario. China is expected to account for more than half of the projected reduction in coal demand as it diversifies electricity generation away from coal. India's net coal imports are projected to double by 2020 compared with 2007, although this level of imports is down almost 60 per cent compared with the reference scenario. Australia is projected to remain the world's largest coal exporter with exports equivalent to 2005 volumes (IEA 2009c).

This strong demand for energy in the IEA's reference case from developing Asian economies, notably China and India, over the next 20 years will create significant scope for Australia to increase its coal exports. In addition, it is assumed that Australia will maintain its share of exports into traditional markets such as Japan and the Republic of Korea. Over the next 20 years, there is the potential for Australia's coal exports to exceed 450 Mt per year, from around 260 Mt in 2008–09. This potential growth includes both thermal and metallurgical coal underpinned by growing import demand throughout developing Asian economies, including China, India, Vietnam and other ASEAN countries. The common thread through all of these economies are the plans to substantially increase electricity generation and steel production capacity as their economies grow. A significant proportion of the planned electricity generation will be coal-fired, reflecting its competitiveness compared with other fuels, its reliability and its wide geographic availability.

Much of the coal required to support new electricity generation capacity is expected to be imported, even in countries that have indigenous coal deposits. This applies particularly in China, India and Vietnam, and reflects the faster rate of consumption growth compared with production growth. China has substantial coal reserves of widely varying quality but many of these have high production or transport costs because of the distance between production and consumption locations. India also has large coal reserves but most of these are located in the centre of the country, whereas a number of planned power stations will be sited along the coastal demand centres. The combination of high internal transport costs coupled with the lower quality of India's coal reserves is expected to underpin its future import growth.

Like thermal coal, increased import demand for metallurgical coal in China will reflect the cost competitiveness of imports. India has very few metallurgical coal reserves and is almost totally reliant on imports. Increased Indian steel production is likely to be based on increased coal imports.

Australia is well situated geographically to capitalise on increased coal demand from Asia. However, there are a number of other countries that also have the potential to increase exports to meet the growth in demand from developing countries. In the Pacific market, where the majority of Australia's coal is exported, other suppliers with growth potential include Indonesia, Mongolia and the Russian Federation (from eastern ports).

Indonesia has been able to increase its exports very rapidly since 2004, in response to growing demand from Asia and bottlenecks within the Australian supply chain that limited export growth. Part of the reason that Indonesia's exports have been able to grow so quickly is that much of the coal is transported from mines to export ships via water. Coal is transported domestically via barges, which load directly onto ocean going vessels. This avoids the long lead times and costs associated with building land-based transport such as railways and coal loading terminals. Indonesian government policies requiring diversification of its domestic energy mix away from the current dependence on oil, as well as general demand growth in the Indonesian economy, may see growth in domestic consumption of coal. However, given the size of Indonesia's coal reserves and the relative ease with which coal can be transported from mines to markets, Indonesia's coal exports seem likely to expand over the next two decades.

In 2008, Mongolia exported around 10 million tonnes of coal, all of which was to China. Mongolia has very large thermal and metallurgical coal deposits which the government aims to develop. For example, the Tavan Tolgoi deposit is estimated to contain reserves

of up to 6 Gt, of which 2 Gt could be metallurgical coal, making it one of the largest undeveloped coal deposits in the world. The development of these resources faces a number of challenges including lack of infrastructure, remote location, harsh winter climate, and Mongolia's landlocked position. Despite the challenges, there is a strong likelihood that Mongolia's coal industry will develop and expand with a large proportion of coal production, at least initially, being exported into northern and western China.

Other countries which also have the potential to significantly increase coal exports are Colombia and South Africa. In the five years to 2008, Colombia's coal exports increased by around one third to 68 Mt. The strong growth reflects Colombia's production of high energy, low sulphur coal, which is exported to the United States and the European Union. Over the long term, Colombia's exports are projected to continue growing, reflecting growing demand in the United States (the low sulphur Colombian coal is blended with the higher sulphur domestic coal) and the European Union where domestic production is expected to continue to decline. Colombia's exports will be underpinned by large reserves and relatively low production costs.

South Africa's coal exports could also increase over the next 20 years. However, there is some uncertainty as to the extent of any growth given that South Africa's coal export growth over the past five years has been constrained by infrastructure bottlenecks. Expansions to infrastructure are expected to be in place from 2010 enabling export growth in the short and medium term. Over the longer term, increased domestic demand for coal associated with increased electricity generation capacity could limit potential export growth.

Strong demand for coal over the past five years has resulted in substantial increases in coal prices (see Box 5.1 for explanation of coal prices). From 1998

to 2003, thermal coal contract prices, in real terms (US\$2008–09), were between US\$32–52 per tonne (figure 5.29). Hard coking coal contract prices were settled around US\$50–70 per tonne. This compares with the past four years when thermal coal prices have been settled above US\$50 per tonne, peaking at US\$125 per tonne in JFY 2008 and metallurgical coal prices being set above US\$100 per tonne, including US\$300 per tonne in JFY 2008.

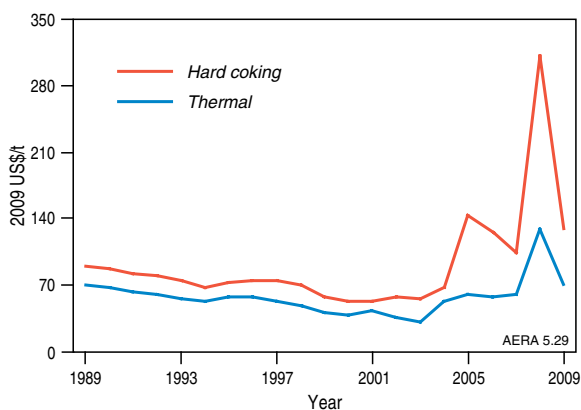
Over the outlook period, strong demand for coal is expected to keep average coal prices within the range of prices seen over the past four years. That is, above US\$60 a tonne for thermal coal and above US\$110 a tonne for metallurgical coal. The higher coal prices, relative to the early part of this decade and the 1990s, reflect in addition to the strong and increasing demand, rising production costs in major coal exporting countries. For example, in Australia and Indonesia, production costs are expected to increase as coal is extracted from deeper seams, while transport costs could increase as new mines are located further inland, increasing the costs of delivering coal to export points.

In summary, projected demand for coal over the next 20 years creates significant opportunity for growth of Australian coal production and exports. However, the Australian coal industry will face a number of challenges in growing to capitalise on the opportunity. The most significant of these – access to substantial but undeveloped deposits and potential infrastructure constraints on exports – are considered in more detail later in this chapter.

### Australia has a substantial coal resource base

Australia has 6 per cent of the world's recoverable EDR of black coal, ranking sixth behind the United States, the Russian Federation, China, India and South Africa. Australia also has the largest share of the world's recoverable economic resources of brown coal (about 25 per cent). Australia ranks fourth in the world in terms of combined recoverable economic coal resources. Australia's total coal resources are substantially larger than this with total identified resources of black coal being around 114 Gt and brown coal resources of 194 Gt. However, the full extent of Australia's very large coal resource base is not known: potential resources have not been assessed because the existing identified resource base is so large.

The resource potential of coal is probably in excess of one trillion tonnes. There are over 25 sedimentary basins with identified resources or coal occurrences and there are areas within these basins that need further exploration. Significant potential also exists in poorly explored basins across the continent (table 5.10).



**Figure 5.29** Australia-Japan coal contract prices  
Source: ABARE 2009d

**Table 5.10** Australia's coal resource potential

Basin	Age (million years)	Potential (Gt)
Pedirka	Permo-Carboniferous (350–225)	600 to 1300 (above 1000 m)
Cooper	Permian (270–225)	+100 (1100–1600 m)
Canning	Permian (270–225)	30 to 36
Galilee	Permian (270–225)	Significant
Arckaringa	Permian (270–225)	Significant
Sydney	Permian (270–225)	Significant
Gunnedah	Permian (270–225)	Significant
Gippsland	Tertiary (70–10)	Significant
Murray	Tertiary (70–10)	Significant

**Source:** Geoscience Australia

The Pedirka, Cooper and Canning basins are all considered prospective for black coal. Given the high quality of coals and proximity to infrastructure in the major east coast basins, the search for coal in these basins has been of low priority.

Strong demand for coal in recent years has stimulated record levels of coal exploration. Although the focus continues to be in the established producing basins, there has been renewed interest in coal resources across the continent which has highlighted Australia's potential for further growth in the resource base.

Coal-bearing sediments extend across vast areas of the continent. This wide geographic spread reflects the variety of conditions under which coal was formed, ranging from tectonically active basin flanks and troughs, such as the Bowen and Sydney basins, to the stable interior basement areas such as the Galilee and Cooper basins.

The potential for building on the known resources can be considered in two categories: (1) discovery of new resources in coal basins with identified resources and (2) discovery of new resources in poorly explored basins. Most producing coal basins have potential for discovery of further resources. Basins with identified resources and significant potential for growth in resources include the Sydney, Gunnedah and Galilee basins.

The current total identified in-situ resources of over 50 Gt in the Sydney Basin cover an area which represents only a small part of the basin's extent. There is significant potential for additional resources at depth, as well as outside the current mining operations and in areas away from identified deposits. It should be noted, however, that although the potential coal resource within the Sydney Basin is significant there are major impediments to potential future use. These include large areas of the basin

being covered by national parks, urban development, infrastructure, stored bodies of water, and prime agricultural land.

The Gunnedah Basin is estimated to contain more than 18 Gt of coal and recent regional exploration has identified substantial resources at depths of less than 300 m. Development of some of these resources will require resolution of competing land use issues and the challenge of new infrastructure requirements.

The Galilee Basin has potential for future discoveries of coal resources. Indicative of the potential of this under-explored basin is the fact that since early 2008 close to 7 Gt of in-situ coal resources have been added to Australia's identified resources. Exploration is continuing in the basin and additional resources are likely to be found. Development of new resources in the Galilee Basin will require extension and further development of infrastructure.

### Infrastructure for new coal developments

Infrastructure is an essential component of the supply chain that links mines to the vessels that transport coal to export markets. In Australia, almost all of the coal is transported via rail from mine sites to ports. Expansion of Australia's coal exports to meet the anticipated demand over the next two decades will require alignment of infrastructure capacity with production capacity (see below). Over the past five years both rail and port infrastructure has been upgraded and capacity expanded (table 5.9). The significant number of new coal projects currently under construction or committed (tables 5.11 and 5.12) are supported by a significant number of planned infrastructure projects, including both expansion of capacity at existing facilities and new facilities that will help meet projected export demand over the next decade (tables 5.13 and 5.14).

In the Bowen Basin, rail infrastructure is well established and additional capacity is being created by expanding existing assets. New rail links will be required to unlock the potential of undeveloped coal basins such as the Galilee and, to a lesser extent, the Surat Basin. For example, Waratah Coal is proposing to construct a 490 km rail line from its proposed mine near Alpha in the Galilee Basin to Abbot Point. Large scale coal production in the Surat Basin will be possible once the Surat Basin Rail has been constructed – a 200 km rail link between Wandoan and Banana. Construction of rail links will be capital intensive. For example, Waratah Coal has estimated its 490 km rail link could cost around US\$1.7 billion: this is in addition to a new coal terminal which could cost around US\$1 billion.

In the Hunter Valley, frameworks are in place to increase the coal handling capacity of the rail and port networks and provide long term capacity

coordination for the Hunter Valley operations by aligning the capacity of coal loading terminals with rail capacity and production. In the short term, port capacity will be increased by completion of stage 1 of the Newcastle Coal Infrastructure Group (NCIG) terminal (30 Mt per year) (ABARE 2009e). Further expansions over the medium term include 27 Mt per year stage 4 expansion of the Kooragang Island Terminal and the 30 Mt per year second stage of the NCIG terminal. These expansions, when complete would give the Port of Newcastle a capacity of over 200 Mt per year. The proposed increase in port capacity is supported by expansions of the rail network as shown in table 5.13. The future capacity expansions are in addition to recent expansions outlined in table 5.9.

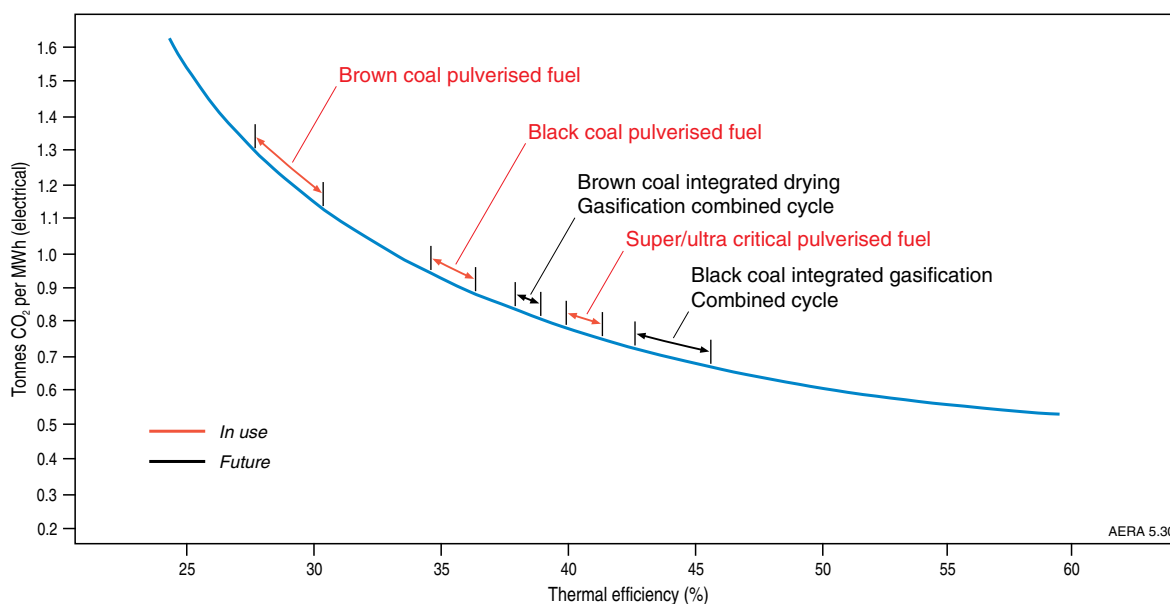
In the first half of 2009, Queensland's port capacity was expanded by around 25 Mt a year following the completion of expansions to the Abbot Point, Brisbane and Dalrymple Bay coal terminals. A further 25 Mt a year expansion of the Abbot Point coal terminal is under construction and scheduled for completion in 2011. There are also several rail projects under construction in New South Wales and Queensland as of October 2009.

In addition to the above mentioned projects, there are 18 infrastructure projects that are at a planning stage, which will significantly increase capacity over the next 20 years. If completed as scheduled, Australia's infrastructure capacity in 2020 could increase to 642 Mt a year (table 5.14), compared with around 350 Mt in 2009.

### New low emissions coal technologies – key to maintaining coal's competitiveness in electricity generation

Technological advances will play an important role in ensuring coal can continue to be consumed around the world in a manner that meets economic and environmental objectives. These advances are aimed at increasing the efficiency (amount of energy generated per unit of coal) and reducing greenhouse emissions. These low emissions coal technologies – also referred to as *clean coal technologies* – include dewatering lower rank coals (brown coals) to improve the calorific quality (increasing efficiency), treating flue gases, gasification (conversion of coal to gas, box 5.5), and technologies to capture and store carbon dioxide (CO<sub>2</sub>).

Development of the new low emissions coal technologies is especially important for Australian electricity generation which is overwhelmingly based on coal-fired power stations. Most coal-fired power stations in Australia (and globally) are based on combustion of pulverised coal (PC) in boilers to generate superheated steam that drives steam turbines to generate electricity. The heat and pressure of the steam determines the relative efficiency of the plant. Efficiencies vary from 20 to more than 40 per cent, depending on the thermal content of the coal used and specific design of the power plant. New generation thermal coal plants are being developed and deployed based on the enhanced efficiency and lower emissions achieved by increasing the temperatures and pressures in the steam turbines – from subcritical to supercritical conditions of temperature and pressure. Efficiency increases to above 40 per cent and emissions fall from around 1000–1400 kg of CO<sub>2</sub> per MWh to less



**Figure 5.30** Thermal efficiencies and carbon dioxide emissions from various coal-fired power generation technologies (without CCS). Technologies in red indicate those current in use, whereas those in black are still to be deployed

Source: CSIRO 2009



than 800 kg CO<sub>2</sub> per MWh with the use of super and ultra-supercritical plants (figure 5.30). The ultra-supercritical pulverised coal boilers can potentially significantly increase efficiency (to over 45 per cent) and markedly reduce (by up to 40–50 per cent) CO<sub>2</sub> emissions to around 700–750 kg CO<sub>2</sub>/MWh (CSIRO 2009). Direct injection plants with even higher thermal efficiencies through removal of impurities in coal and using coal-water mixtures or direct carbon fuel cells are also being developed.

Most new coal fired plants use supercritical pulverised coal technology and achieve efficiencies of 40 per cent or more and around 20 per cent reductions of CO<sub>2</sub> per MWh compared with the older sub-critical plants. The first ultra-supercritical pulverised coal plants with capacities of up to 1000 MW have begun to be deployed in a number of countries including China, Germany and the United States. There is continuing research and

### BOX 5.2 ENHANCING THE EFFICIENCY OF EXISTING COAL PLANTS

A number of options are available to achieve modest improvements in efficiency and greenhouse gas reductions at existing coal plants.

- Higher efficiency steam turbines** – Recent research and development has improved the performance of steam turbine blades. Modern turbine blades can be retrofitted into existing steam turbines with an increase in turbine efficiency of up to 3 per cent. Some Australian power stations have already installed these modern blades (e.g. Loy Yang Power). Another 1 per cent efficiency gain is available by improving turbine seals (SKM 2009).
- Boiler efficiency improvement** – Boiler efficiency can be improved by increasing the boiler heat transfer surface area to remove more heat from the flue gas before discharging it to the atmosphere. This requires additional equipment and capital outlay (SKM 2009).
- Improved efficiency of auxiliary drives** – For power stations that are subject to varying demand there is a trend towards variable speed drives and away from the traditional fixed speed type. The use of variable speed drives enables the driven machine to be controlled to an optimum output. Improved pumps and fans can also be fitted in many instances to obtain power savings (SKM 2009).
- Pre-drying brown coal** – Brown coal can have up to 66 per cent moisture content. Pre-drying removes some moisture before the coal is burnt and avoids latent heat loss than if it remained in the fuel. Pre-drying brown coal reduces carbon dioxide emissions close to a level achieved by black coal. For example, at Loy Yang Power a \$6.3 million Mechanical Thermal Expression (MTE) pilot plant was tested in 2007–08. The MTE process allows more than 70 per cent of the water in brown coal to be removed with the potential to significantly reduce CO<sub>2</sub> emissions when the dry coal is burnt to generate electricity.
- Biomass co-firing** – Biomass co-firing in coal-fired power stations can reduce carbon dioxide emissions approximately proportional to the proportion of biomass used. Wood waste is generally used because coal fired boilers can usually co-fire a small amount of wood waste without major modification to the existing equipment. It is unlikely for most large power stations that the biomass available to co-fire would represent more than 1 per cent of the fuel input on an energy basis (SKM 2009). A number of large coal fired power stations have trialled co-firing mainly wood waste including, Hazelwood, Bayswater, Liddell, Mt Piper, Muja, Vales Point B and Wallerawang. At Muja 78 000 tpa of sawmilling residue is burnt displacing 45 000 tpa of coal and saving an estimated 90 000 tpa of greenhouse gas emissions ([www.verveenergy.com.au](http://www.verveenergy.com.au)).
- Co-firing natural gas** – The conversion of coal fired power boilers in full or in part to use natural gas will reduce the greenhouse gas emissions because natural gas has lower carbon emissions than coal. However, this will incur higher fuel costs. Natural gas of up to 25 per cent of the fuel energy can be co-fired in black coal boilers without extensive modification to the heat transfer surfaces (SKM 2009).
- Solar heating** – Solar energy using high temperature solar thermal technology is being considered to provide steam and augment or replace boiler feed-water at existing coal power stations and result in reduced greenhouse gas emissions. Solar Heat and Power Pty Ltd has undertaken research and development on a Compact Linear Fresnel Reflector array which has been used to reheat water at the Liddell coal fired power station.
- Algal capture** – Algae can be used to capture carbon dioxide emissions and produce biofuel and livestock feed. Under an agreement with MBD Energy Ltd, Tarong Energy, Loy Yang Power and Eraring Energy will build an algal carbon capture, storage and recycling process. The MBD Energy process produces oil-rich micro algae suitable for oil for plastics or fuel and a stock feed. Pilot plants using MBD Energy's technology are planned to be constructed at the three companies coal fired power stations ([www.mbdenergy.com](http://www.mbdenergy.com)).

### BOX 5.3 NEW LOW EMISSIONS COAL TECHNOLOGIES

#### *Oxyfuel combustion*

Oxyfuel combustion involves firing a conventional coal-fired power station boiler with oxygen and recycled exhaust gases instead of air to produce a stream of highly concentrated CO<sub>2</sub> in the flue gas. This CO<sub>2</sub> can then be readily captured by cooling and compression to a liquid for separation and transport to geological storage. Oxyfuel combustion and capture has the advantages of relative simplicity of the process and potentially lower costs compared with other emergent CO<sub>2</sub> capture technologies. It can also be retrofitted to existing boilers in pulverised coal plants.

Oxy-fuel combustion boilers have been studied on a case-by-case basis in laboratory-scale and small pilot units. The Callide Oxyfuel project aims to demonstrate oxyfuel combustion and CO<sub>2</sub> capture by retrofitting a 30 MWe coal-fired boiler at CS Energy's Callide 'A' coal power station in Queensland. This will create a highly concentrated stream of CO<sub>2</sub> suitable for capture and storage deep underground in geological formations west of the power station. The Callide project aims to demonstrate the viability of technology capable of reducing emissions from a typical coal-fired power station by 90 per cent.

#### *Integrated Gasification Combined Cycle (IGCC)*

IGCC power plants rely on a process known as coal gasification, which involves reacting coal with air or oxygen to create a synthetic gas or Syngas (also known as coal gas or 'town' gas), a mixture of carbon monoxide (CO) and hydrogen (H<sub>2</sub>). Syngas is combustible but has only half the energy density of natural gas, and is used as a fuel or as an intermediate step for the production of other chemicals. Syngas was extensively used for street lighting prior to the development of electricity.

In the IGCC plant, syngas produced by reacting coal with air or oxygen under high temperatures and

pressures is used as fuel in a gas turbine to produce electricity (figure 5.31). The carbon monoxide in the Syngas can be cleaned and reacted with water to convert it to CO<sub>2</sub>. The CO<sub>2</sub> can then be separated for storage leaving a stream of pure hydrogen that is fed into the gas turbine. The combustion product of hydrogen in the gas turbine is principally water vapour. Heat recovered from both the gasification process and the gas turbine exhaust is used in boilers to produce steam in a steam turbine to produce additional electrical power. The IGCC process therefore combines the two cycles (Rankine and Brayton cycles) to achieve an operating efficiency of greater than 40 per cent. Research is being undertaken to improve the efficiency of combined cycle turbines, and to develop special turbines specifically to be used with hydrogen.

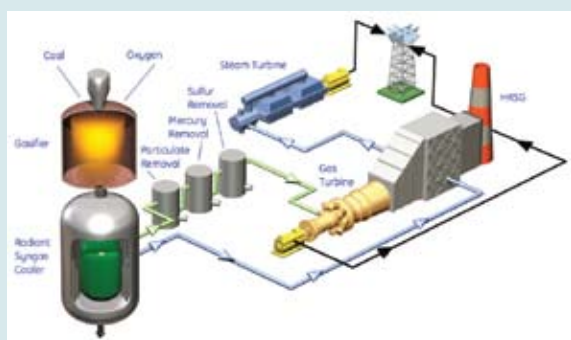
IGCC without carbon capture and storage is approaching commercial deployment. There is a number of commercial-sized demonstration IGCC plants operating in several countries with outputs up to 400 MW and plans have been announced to develop several new IGCC power plants. As well as improved efficiencies and lower greenhouse gas emissions IGCC technology offers the potential to more economically capture CO<sub>2</sub> emissions.

There are several projects in Australia being developed to use IGCC, including some with CCS.

The Wandoan project in Queensland, currently in the development phase, proposes to build a 400 MW IGCC power station capable of capturing and storing up to 90 per cent of CO<sub>2</sub> emissions. This plant has a scheduled start up in late 2015 or early 2016. This project is being developed by a partnership between GE Energy and Stanwell.

ZeroGen Pty Ltd proposes to build a commercial-scale 530 MW IGCC plant with CCS technology in Central Queensland with a planned deployment date of 2015. The project partners include Mitsubishi Corporation (MC)/ Mitsubishi Heavy Industries (MHI), and project is supported by the Queensland Government and the Australian Coal Association (through their Low Emissions Technologies program).

HRL Ltd has developed Integrated Drying Gasification Combined Cycle technology based on brown coal. A proposed 550 MW power station project that will demonstrate the technology is planned at Morwell, in the Latrobe Valley, Victoria.



**Figure 5.31** Integrated Gasification Combined Cycle with carbon capture and storage/sequestration

**Source:** Image Courtesy of GE Energy



development into new materials (e.g. nickel-based alloys) that will enable operation at temperatures above 600°C and pressures above 25 MPa.

All but the most recent of Australia's 21 GW of black coal and 7.5 GW of brown coal-fired power plants are based on subcritical pulverised coal technology. Pulverised coal technology is currently the cheapest large scale electricity generation process. Most new pulverised coal power stations are likely to be of supercritical or ultra-supercritical type given substantial improvements in efficiency and greenhouse gas reductions offered by these technologies. Retirement of subcritical pulverised coal plants and replacement

by supercritical plants could significantly enhance efficiencies and reduce CO<sub>2</sub> emissions. However, not only would this require major capital investment, but many of the existing subcritical plants have remaining technical operating lives.

A number of approaches are being and have been adopted to improve the efficiency of existing coal plants and achieve reductions in greenhouse gas emissions without incurring the major costs that are associated with significant changes to the design conditions, materials and equipment configuration of existing plants. These improvements include: more efficient steam turbines; improvements to

#### BOX 5.4 CARBON CAPTURE AND GEOLOGICAL STORAGE: CCS

CCS is a key greenhouse gas mitigation technology for Australia. Burning fossil fuels such as coal, natural gas and oil releases carbon dioxide (CO<sub>2</sub>) and other greenhouse gases (GHG) to the atmosphere adding to the potential for climate change.

Approximately 75 per cent of Australia's annual 550 Mt of GHG emissions are the result of fossil-fuel energy production (including electricity generation, transport, and manufacturing and construction) (DCC 2009). Due to the heavy reliance on coal and natural gas (in total providing over 95 per cent of fuel input), electricity generation alone accounts for over 200 Mt of GHG emitted annually. Australia's abundant supply of coal and natural gas, combined with Australia's status as the world's largest coal supplier and the increasing domestic demand for continued low cost energy means that the use of fossil fuels for energy and electricity generation will increase. CCS technologies could assist in mitigating a significant proportion of the GHG emissions resulting from our continued and increasing use of fossil fuels (Geoscience Australia 2008).

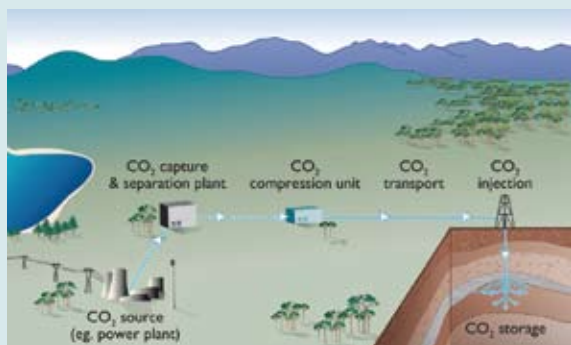
Geological storage is the process of capturing CO<sub>2</sub> from stationary emission sources such as power stations, industrial facilities, or natural gas production and injecting it deep underground as a dense fluid into geological formations, preventing

it from entering the atmosphere (figure 5.32). One of the most critical factors in geological storage is identifying rocks with suitable pore volumes for storage and cap rocks for sealing.

Many sedimentary rocks, particularly sandstones, contain large volumes of fluids (these include: water, hydrocarbons, CO<sub>2</sub>, and other gases) held in microscopic voids or pores between rock grains. These pores can form up to 30 per cent of the rock volume (figure 5.33). Where the pores are interconnected the rock has permeability, that is, fluids can flow through it. Deep in the geological section, rocks like sandstones are usually filled with highly saline water that moves very slowly over millions of years. They are called deep saline reservoirs, and they are the 'containers' proposed for storing greenhouse gases because they are too deep and too saline for any other practical use.

CO<sub>2</sub> injected into a saline reservoir becomes trapped in the rock through a number of mechanisms. Initially the CO<sub>2</sub>, which is less dense than water, rises buoyantly through the reservoir until it meets a barrier – an impermeable cap rock (the seal, or 'lid', to the reservoir) such as a mudstone or shale (figure 5.34). The CO<sub>2</sub> will accumulate under the cap rock and spread out laterally beneath it. Some of the CO<sub>2</sub> will be caught in pores between grains of rock, and will not move any further. Over time, a significant portion of the rest of the CO<sub>2</sub> will dissolve in the saline formation water and be stored in solution while some of the CO<sub>2</sub> and water will react with minerals in the rock to precipitate new minerals. Storage sites are carefully selected and characterised to ensure that a suitable cap rock is present to prevent CO<sub>2</sub> from migrating out of the designated reservoir.

The most suitable reservoir and cap rocks are found in sedimentary basins, and particularly in hydrocarbon producing basins. In general, deep saline reservoirs have the greatest potential capacity to store CO<sub>2</sub>, because they are widespread, large, and are presently not used for other purposes.



**Figure 5.32** The carbon dioxide capture, transport, injection and storage process

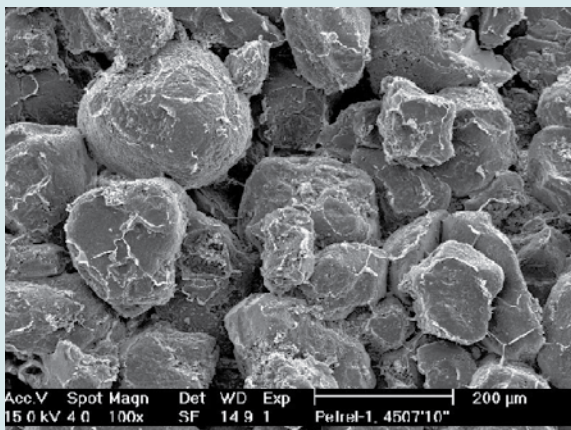
Source: CO2CRC ([www.co2crc.com.au](http://www.co2crc.com.au))

Depleted oil and gas fields may also be used to store CO<sub>2</sub>, although these are much smaller in volume and in some cases are either not available for use (i.e. are still producing hydrocarbons) or will be used for other purposes such as natural gas storage. The advantage of using depleted fields is that they are well characterised and have already demonstrated that they can trap and retain large volumes of hydrocarbons. Other options include storage in deep coal seams, basalts, shales, as CO<sub>2</sub> hydrates beneath the sea floor, and through mineral carbonation. Many of these latter options are at early stages of development and may only provide niche storage opportunities. National geological assessments of storage resources in Australia (APCRC 2003; Carbon Storage Taskforce 2009), indicate that Australia has sufficient storage space to make a significant impact on our GHG emissions from stationary sources. For Australia, nearly all of this resource is in deep saline reservoirs where there is ample volume and no potential resource conflict (e.g. with hydrocarbon or fresh water production).

Many of the concepts around geological storage of CO<sub>2</sub> have been taken directly from the petroleum industry which has extensive experience with oil and natural gas (including naturally occurring CO<sub>2</sub>) in the subsurface. Studies of hydrocarbon accumulations around the world have shown that fluids have remained trapped in deep geological formations and structures for tens to hundreds of millions of years. This gives confidence that injected CO<sub>2</sub> can be securely stored in similar geological settings for similar amounts of time. Demonstrating the security and safety of storage before, during and post injection is of particular concern to government, industry and the public. Potential points of leakage include faults, cap rocks, and pre-existing petroleum

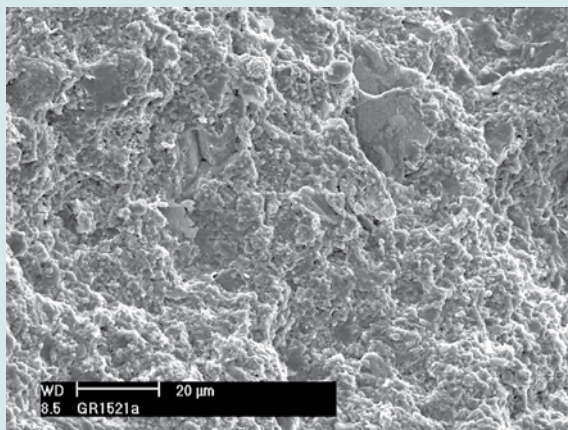
wells. The former two are mitigated through good geological characterisation of an injection site, while the latter is mitigated through careful design and engineering. In addition, both new and existing techniques are being used to track CO<sub>2</sub> in the subsurface, including seismic imaging, down-hole pressure measurement and gas and water sampling, and shallow aquifer groundwater sampling. Surface monitoring techniques such as atmospheric and soil gas sampling will ensure that in the unlikely event that any CO<sub>2</sub> migrates to the surface it will be detected and remedied immediately.

Capture, injection and geological storage of CO<sub>2</sub> is an established process in the petroleum industry and is already occurring at commercial scale (more than 1 Mt CO<sub>2</sub> per year) at several locations globally. These include Statoil's Sleipner and Snohvit gas fields in the North and Barents Seas respectively, BP's gas project at In Salah in Algeria, and the enhanced oil recovery project at the Weyburn and Midale fields in Canada. In addition, over 50 Mt of CO<sub>2</sub> are transported over more than 3000 km of dedicated CO<sub>2</sub> pipelines and injected each year for enhanced oil recovery in North America. In Australia, one of the largest research storage projects in the world, the CO2CRC's pilot CO<sub>2</sub> injection project in the Otway Basin in Victoria, has injected 65 000 t of CO<sub>2</sub> into a depleted gas field, and a further injection project into a saline reservoir is planned. The ZeroGen project in Queensland is developing a 530 MW IGCC power station with planned capture and storage of about 60 Mt of CO<sub>2</sub> in total. The Gorgon natural gas project offshore Western Australia will store 125 Mt of naturally occurring CO<sub>2</sub> separated from the produced gas. There are a number of other projects in various stages of planning or implementation (figure 5.35).



**Figure 5.33** Microscope image of a reservoir rock – a porous and permeable sandstone

**Source:** Gibson-Poole et al. 2002



**Figure 5.34** Microscope image of a cap rock – an impermeable mudstone

**Source:** Daniel 2006

### Major Government initiatives in CCS

The Australian Government is supporting a range of initiatives and policies to accelerate the development and deployment of CCS in Australia (RET 2009). These include the:

- \$4.5 billion **Clean Energy Initiative**, to support research, development and demonstration of low emissions energy technologies, including \$2 billion to support the construction and demonstration of two to four large scale CCS projects from 2015 under the CCS Flagships Program.
- \$400 million, over eight years, **National Low Emissions Coal Initiative**, which includes support for the CCS Flagships Program and the National Carbon Mapping and Infrastructure Plan. This initiative aims to accelerate the development and deployment of technologies to reduce emissions from coal-powered electricity generation, while securing the contribution that coal makes to Australia's energy security and economic wellbeing.
- Carbon Storage Taskforce, whose mission is to develop the **National Carbon Mapping and Infrastructure Plan**. The purpose of the NCMIP is to promote prioritisation of, and access to, national geological storage capacity and

associated infrastructure requirements needed to accelerate deployment of CCS in Australia.

- **Commonwealth CCS Legislation.** *The Offshore Petroleum and Greenhouse Gas Storage Act 2006*, the world's first national legislation enabling CO<sub>2</sub> storage, provides a framework for access and property rights for the geological storage of greenhouse gases such as CO<sub>2</sub> in Commonwealth offshore territory, that is, greater than three nautical miles from the coast. In another world first, in March 2009 the Australian Government released ten offshore areas for bids for the rights to explore for greenhouse gas storage sites.
- **Global Carbon Capture and Storage Institute (GCCSI).** In 2009, the Australian Government established the GCCSI with annual funding of up to \$100 million in order to address barriers, and accelerate deployment of industrial scale carbon dioxide capture, transport, and storage technologies globally. The Institute aims to build sufficient confidence in the technology, by helping to facilitate the deployment of fully integrated large-scale carbon capture and storage projects globally.



**Figure 5.35** Active and proposed CCS projects in Australia

Source: Geoscience Australia 2008



boiler efficiency; pre-drying brown coal; co-firing with gas or biomass; the use of solar heating; and biosequestration of CO<sub>2</sub> emissions (box 5.2). On the other hand, the use of dry cooling in carbon capture and storage to reduce water usage has the effect of lowering efficiency.

### Carbon capture and storage (CCS)

Carbon capture and storage (CCS) is a greenhouse gas mitigation technology that can potentially reduce CO<sub>2</sub> emissions from existing and future coal-fired power stations by more than 80 per cent. Current and new coal combustion technologies (based on pulverised coal technologies) are approaching maximum efficiency and greenhouse gas emission intensity limits (figure 5.30). Further reduction of CO<sub>2</sub> emissions requires the capture (as a supercritical fluid), transport and (geological) storage of CO<sub>2</sub>. CCS has not yet been demonstrated at the scale needed for power plants, and until the technology matures implementation of CCS is likely to add significantly to the costs of production of electricity. Large scale demonstration plants with CO<sub>2</sub> storage are expected to start operation in 2015, with an aim to have the technology commercially available by 2020.

There are three main approaches to reducing emissions from coal use by removing CO<sub>2</sub>. One of these removes CO<sub>2</sub> before the coal is burned to produce electricity (i.e. pre-combustion using Integrated Gasification Combined Cycle technology) whereas the other two remove the CO<sub>2</sub> after combustion (oxyfuel combustion and post-combustion capture).

#### Integrated Gasification Combined Cycle (IGCC)

involves reacting coal at high temperatures and pressures with oxygen and steam to convert the coal to synthetic gas (Syngas). Syngas is predominantly a mixture of hydrogen (H<sub>2</sub>) and carbon monoxide (CO) and commonly some carbon dioxide (CO<sub>2</sub>). Syngas is combustible and can be used as a fuel although it has less than half the energy density of natural gas. In the IGCC the Syngas is combusted in a high efficiency combined cycle system, which comprises a gas turbine driving a generator (box 5.3). The hot exhaust gas from the gas turbine raises steam for a steam turbine.

**Oxyfuel combustion** involves burning pulverised coal with pure oxygen rather than air, to produce a stream of highly concentrated CO<sub>2</sub>. This enables the CO<sub>2</sub> to be more readily captured (without the use of solvents) by cooling and compression to form liquid CO<sub>2</sub> for transport to geological storage (box 5.3).

**Post-Combustion Capture** involves the separation of CO<sub>2</sub> from the flue gases released in the combustion process. This is generally done by contacting the gases with a chemically reactive liquid (commonly an amine or ammonia solution) to capture the

CO<sub>2</sub>. The CO<sub>2</sub> is then removed from the absorbing solution by heating, compressed and transported to an underground storage location. Because post-combustion capture occurs after the combustion process, this technology can be retrofitted to existing combined cycle plants.

### Other coal conversion technologies

Coal can also be converted into other synthetic fuels, including liquid fuels that can be used as transport fuels. Conversion of **coal to a liquid (CTL)** – a process also known as coal liquefaction – can be achieved directly or via synthetic gas (syngas). Direct liquefaction works by dissolving the coal in a solvent at high temperature and pressure. Although this process is highly efficient the liquid products require further refining to be suitable as high grade fuels. In the more common indirect CTL method coal is gasified to form syngas and then condensed over a catalyst – the ‘Fischer-Tropsch’ process – to produce high quality, ultra-clean fuel products (box 5.5).

There has been little interest in CTL projects until recently because of the ready availability of relatively low cost crude oil and the high capital and operating costs of CTL plants. South Africa has the largest CTL industry in operation today with a CTL capacity of more than 160 000 barrels of oil per day. CTL plants provide some 30 per cent of South Africa’s liquid transport fuels needs. In Australia from 1985 to 1990 a Japanese consortium operated a CTL pilot plant at Morwell which demonstrated that hydrogenation of Latrobe Valley brown coal was technically feasible. A CTL project commenced production in China in late 2008.

However, rising oil prices and concerns about security of oil supply have prompted renewed interest in CTL technologies and there are currently more than 50 projects worldwide with two thirds of those in China and the United States (World CTL Association 2009). Significant challenges to the uptake of CTL projects are the high capital costs and the high greenhouse gas footprint of CTL projects. New CTL projects are likely to require some form of carbon capture and storage (CCS) to reduce the greenhouse gas emissions. The capital costs have been estimated at approximately US\$60 000 to US\$120 000 per barrel per day (excluding the costs of CCS), equivalent to a capital cost of US\$4 billion for a 40 000 barrel per day CTL plant (World CTL Association 2009).

A number of companies are currently investigating the feasibility of CTL plants in Australia including New Hope Corporation at the New Acland mine (Queensland), Ambre Energy Ltd at Felton (Queensland), Spitfire Oil at Salmon Gums (Western Australia), Blackham Resources at Scaddan (Western Australia), Hybrid Energy Australia at Kingston

(South Australia), Altona Resources at Wintinna (South Australia) and Syngas Ltd at Clinton (South Australia).

A number of projects are actively considering projects involving **underground or in-situ coal gasification (UCG)**. In this method fuel gases are produced underground when a coal seam gets sufficient air to burn but insufficient for all consumable products to be consumed. The gasified coal can then be used to produce liquid fuels (or electricity).

UCG technology has evolved through numerous trials since the early 1900s but has been only used on a commercial scale for power generation in the former Soviet Union where it has operated for over 40 years. UCG provides access to deep coal and other stranded coal resources avoiding the need to mine and process it. There has been renewed interest in coal gasification in recent years with a number of projects at different stages of evaluation. There are about 30 underground coal gasification projects at various stages in China alone.

### BOX 5.5 COAL CONVERSION TECHNOLOGIES

#### Coal to Liquids (CTL)

The production of liquids from coal requires the breakdown of the chemical structures present in coal with the simultaneous elimination of oxygen, nitrogen and sulphur and the introduction of hydrogen to produce a stable liquid product. Syngas produced from coal gasification can be converted into a variety of products including petrol, diesel, jet fuel, plastics, gas, ammonia, synthetic rubber, naphtha, tars, alcohols and methanol using the Fischer-Tropsch process (figure 5.36). Coal-derived fuels have the advantage of being sulphur-free, low in particulates, and low in nitrogen oxides.

CTL technology was developed in the early 20th century and was used in Germany in the 1930s and 1940s. Since 1955 in South Africa, Sasol has operated CTL plants and in late 2008 the Shenhua Group commissioned a CTL plant at Ordos in China. There are some 50 CTL projects being considered around the world with the bulk of these in China and the United States. Synthetic fuels produced by CTL processes have been tested for suitability as jet fuel in aeroplanes. Coal as a potential source of liquid

fuels has the advantage of being both widespread and relatively low cost. For some countries it may decrease reliance on oil imports and improve energy security.

#### Underground Coal Gasification (UCG)

Synthetic gas (syngas) can be produced also by underground or in-situ coal gasification (figure 5.37). In this method fuel gases are produced underground when oxidants (generally air) are injected into an unmined coal seam causing the coal to burn but combustion is insufficient to consume all combustible material. Carbon dioxide, carbon monoxide, hydrogen and methane are produced to yield a gas of low but variable heat content. Air is pumped into the burning coal bed through a well, and the gas is drawn off from a point behind the 'fire-front' through another well. The gasified coal can then be used to produce a range of liquid fuels (or electricity) as well as other chemical feedstocks and fertilisers. UCG technology could also have synergies with CCS as the CO<sub>2</sub> could be stored in the coal cavity after gasification.

The power station at Angren in Uzbekistan has the only operating underground coal gasification project in the world. At present, many projects are in various stages of development in the United States, Canada, South Africa, India, Vietnam, Australia, New Zealand and China to produce electricity, liquid fuels and synthetic gas. In Australia projects being developed include: Linc Energy's Chinchilla Project, Carbon Energy's Bloodwood Creek Project and Cougar Energy's Kingaroy Project, all in Queensland.

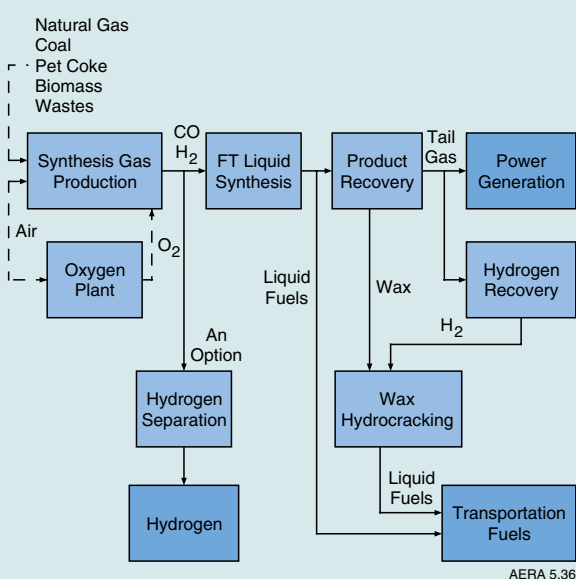


Figure 5.36 Fischer-Tropsch Technology

Source: Sustainable Design Update ([www.sustainabledesignupdate.com](http://www.sustainabledesignupdate.com))

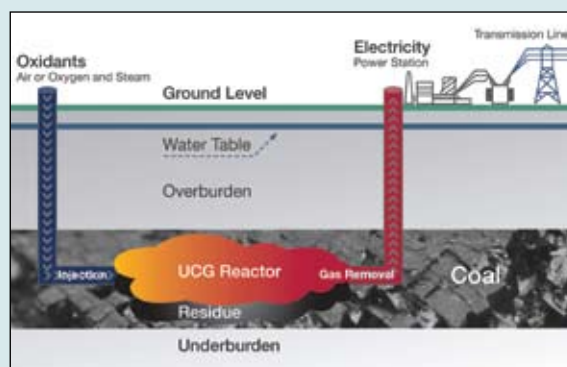


Figure 5.37 Underground Coal Gasification Process

Source: Cougar Energy ([www.cougarenergy.com.au](http://www.cougarenergy.com.au))



UCG has been successfully demonstrated at the Chinchilla project (Linc Energy 2009) in the Surat Basin in Queensland. A major trial from 1999–2003 achieved 95 per cent recovery of coal resource and 75 per cent total energy recovery with a high availability of produced syngas. A gas-to-liquid (GTL) plant to produce clean liquid fuels from UCG syngas began production in late 2008.

### Utilisation of coal resources – competing land use

Australia's major coal resources are located mostly on the eastern seaboard in relatively close proximity to ports and the major industrial and urban power demand centres. Continued development of the coal industry, especially the development of new coal mines, will require access to land for mining and transport of the coal. Future development of these resources will need to take into account competing land uses and various environmental issues.

Companies lodging mine development proposals are required to consult with governments and community stakeholders and undertake assessments of the potential impact of any proposed mining project on the environment (including assessments of any impacts under the *Environment Protection and Biodiversity Conservation Act 1999*) and on third parties such as the community. Where land title is held privately, there is usually a legislative requirement to seek the consent of the land owner (or occupier) and negotiate compensation for access.

Coal mining has taken place in New South Wales for more than 200 years and many mines operate in close proximity to urban and semi-rural areas, high-value agricultural land, metropolitan water storages and in some locations national parks (e.g. south of Sydney). In Queensland, much of the coal production is from open cut (surface) mines in areas of low agricultural value and at locations remote from cities, although underground mining does take place in central Queensland.

Development of new coal mining projects in areas with land of higher agricultural value and other existing land uses will require balancing competing land use interests, particularly those of agriculture, water management (both surface and ground water), and coal mining activities.

Future development of coal projects is likely to require planning for land access corridors. Proposals for new coal-fired power stations are likely to require the identification of suitable geological sites and pipeline infrastructure needed to support capture and storage of carbon dioxide. For geological storage, potential sites may need to be identified and

assessed for suitability and approved for injection and storage.

### Water management

Water is required at the coal mine site for a range of uses, including dust suppression, removal of mineral residues, washing of vehicles and for human consumption. Water is also a key input for coal washing, a cleaning process undertaken to reduce contamination prior to use. Water is also used for dust suppression at ports.

Water used by the coal industry is obtained from a variety of sources including mains supply, rivers, lakes, onsite surface runoff and storm water, mine water, ground water, and recycled water. This water is accessed in the context of competing uses, including for agriculture, industry, human consumption and environmental flows. The recent drought has highlighted the need to manage water more efficiently, and escalated the priority given to water management issues across all levels of government in Australia.

Both New South Wales and Queensland have water legislation and policies in place to support the sustainable and integrated management of their water resources. The *Water Management Act 2000* provides the statutory framework for water management in New South Wales, while water legislation in Queensland is embodied in the *Water Act 2000*. A key element of the legislation in both states is the voluntary trading of water entitlements, which is being implemented progressively. By allowing water to be allocated to those uses with the highest net benefit, water trading can contribute to a more efficient use of water resources. Another key element of the legislation in both states is the progressive introduction of water sharing resource plans. The aim of the plans is to balance future water demands across different types of water users, and provide a secure allocation of water for these uses.

Current legislation enables coal mining companies to better manage their water issues. Typically, coal mines have either too much water or too little water. Where water is in short supply, allocation can be bought from other allocation holders to fill a deficit. In the case of surplus water, arising for example from excessive ground water in mining areas, arrangements can be put in place through catchment water sharing plans to use the water for other commercial purposes.

More broadly, the National Water Commission is undertaking a \$2 million study looking at the cumulative impacts of mining on groundwater resources. The study, due for completion in June 2010, will appraise the planning and permitting practices across jurisdictions and the work undertaken by the mining industry with water management. It will also develop consistent and

rigorous methodologies that will improve the ability to assess and forecast the availability, condition and effects of mining on groundwater resources.

### Capital and other issues

In conjunction with access to infrastructure, access to adequate capital and a supply of skilled labour will be critical to the growth of Australia's coal industry. Expansion of Australia's coal production and infrastructure to provide the export capacity to meet growing global demand for coal potentially involves major capital expenditure of at least \$10 billion and potentially more than \$50 billion over the next 10 years or so (ABARE 2009e). Capital requirements for advanced stage mining projects total \$6.1 billion with a further \$2.9 billion in coal infrastructure (tables 5.11 and 5.13). Capital requirements for the less advanced coal projects exceed \$26 billion for mining projects and \$13.5 billion in coal infrastructure (tables 5.12 and 5.14).

Modification and/or replacement of current coal-fired power stations (mostly subcritical pulverised coal technology) with lower emissions technology, including capture and geological storage of CO<sub>2</sub>, to meet future emissions reduction targets will also require major capital investment.

These capital requirements need to be considered against the global demand for capital to meet growing energy needs and the global transition to lower emissions energy technologies. These capital requirements could be as large as US\$10.5 trillion over the next 20 years, amounting to an annual additional capital investment of around US\$430 billion, equivalent to 0.5 per cent of global GDP (IEA 2009c).

Another, although less substantial, potential constraint that may impact on the medium to long term prospects of the Australian coal industry is availability of an adequate pool of skilled labour. This will be particularly important as more technically advanced and capital intensive projects come on line. In the five years to the middle of 2008, demand for labour within the mining industry increased rapidly leading to labour shortages at some coal mines. Part of the cost inflation experienced at mining and infrastructure construction sites between 2005 and 2008 has been attributed to the short supply of essential skills which led to increased engineering and construction costs.

#### 5.4.2 Outlook for coal market

Increased global demand for coal (projected by the IEA in its reference scenario to be 1.9 per cent per year over the period to 2030) is expected to result in increased Australian coal production and exports. However, the impact of the Renewable Energy Target (RET) and a 5 per cent emissions reduction target

is projected to result in a decline in coal's share of domestic electricity generation. Details of the assumptions underpinning these projections can be found in Chapter 2.

### Key projections to 2029–30

ABARE's latest long-term projections, assuming the RET, a 5 per cent emissions reduction target below 2000 levels by 2020 and other government policies (ABARE 2010), include:

- Coal production increases at an average rate of 1.8 per cent per year to total 13 875 PJ (720 Mt). Increased production will be underpinned by export demand.
- Coal consumption is projected to decrease at an average annual rate of 0.8 per cent to 1763 PJ in 2029–30. The share of coal in total primary energy consumption will fall to 23 per cent in 2029–30.
- Coal's share of domestic electricity generation is projected to decline to 43 per cent in 2029–30, as coal is replaced by renewable and other lower emissions energy sources.
- Australia's exports of coal are projected to increase by 2.4 per cent per year to 12 112 PJ (450 Mt) in 2029–30. Exports are likely to account for around 85 per cent of production in that year.

### Production

Australia's coal production is projected to increase significantly over the next 20 years, supported by strong demand from global markets. This will more than offset the projected decline in domestic demand under a 5 per cent emissions reduction target. Production is expected to grow by nearly 50 per cent over the period to 2030, equivalent to an annual increase of 1.8 per cent to reach 13 875 PJ in 2029–30 (ABARE 2010). The majority of additional coal production is expected to be sourced from New South Wales and Queensland where export quality coal is mined and where necessary infrastructure is in place.

### Consumption

Australia's coal consumption is projected to decline by an average annual rate of 0.8 per cent to reach 1763 PJ by 2029–30. Coal's share of total primary energy consumption is projected to fall to 23 per cent in 2029–30.

The most important driver of lower coal consumption is the projected reduction in electricity generation from coal-fired power plants. The RET will encourage increased electricity generation from renewable fuels sources, while the introduction of emissions reduction targets will make coal less cost competitive compared with other fuels such as gas.

## Electricity generation

The nature of Australia's electricity generation is projected to change significantly in response to the introduction of the RET and emissions reduction targets. Coal has historically underpinned Australia's electricity production and in 2007–08 coal accounted for around three quarters of Australia's electricity generation. Coal is projected to account for 43 per cent of electricity generation in 2029–30 (figure 5.38).

Although coal-fired electricity generation is projected to decline in the period to 2030, new coal-fired electricity capacity is still planned in Australia. As of October 2009 there were two coal-fired power stations (black coal) at an advanced stage, each of more than 200 MW, one in New South Wales (upgrade) and one in Western Australia (table 5.15). In addition, there are a further six black coal and two brown coal power stations at a less advanced stage (table 5.15). A number of the less advanced coal projects incorporate CCS or coal-to-liquids or coal gasification as well as electricity generation.

## Exports

Australia's coal exports are projected to continue to grow strongly with the strong growth in exports underpinned by growth in coal import demand, particularly from developing economies such as China and India. Australia's coal exports are projected to grow at an annual rate of 2.4 per cent and reach 12 112 PJ (450 Mt) by 2029–30 (figure 5.39).

The growth in exports is expected to occur in New South Wales and Queensland. In New South Wales

continued expansion of the Hunter Valley and further development in the Gunnedah Basin is expected to underpin increased exports. Expansion of production capacity in the Bowen Basin and the development of mines in the Galilee Basin is expected to support increased coal exports from Queensland.

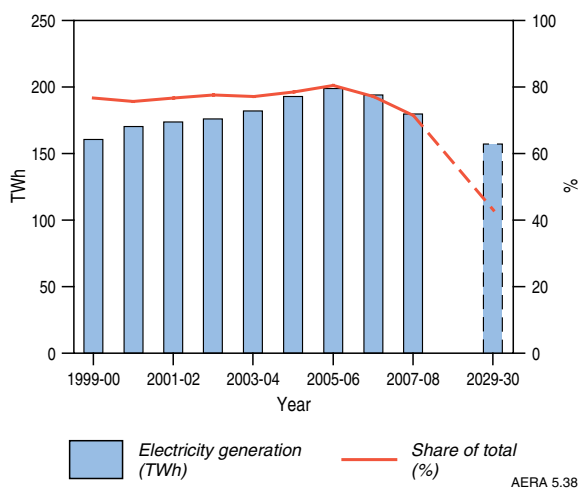
## Proposed development projects

The long term expansion of Australia's coal production and exports will be underpinned by a number of projects that are currently under construction or at various stages of planning.

At the end of October 2009, there were 12 coal projects under construction (table 5.11), scheduled to be completed at various times over the next three years. Of the 12 projects, seven are located in Queensland and five are in New South Wales. The projects have a combined coal capacity of around 50 Mt, at an estimated capital cost of \$6.1 billion. The largest of these, in terms of capacity, are Clermont (which is a replacement for the depleting Blair Athol mine) and Moolarben. Both have capacities in excess of 10 Mt per year.

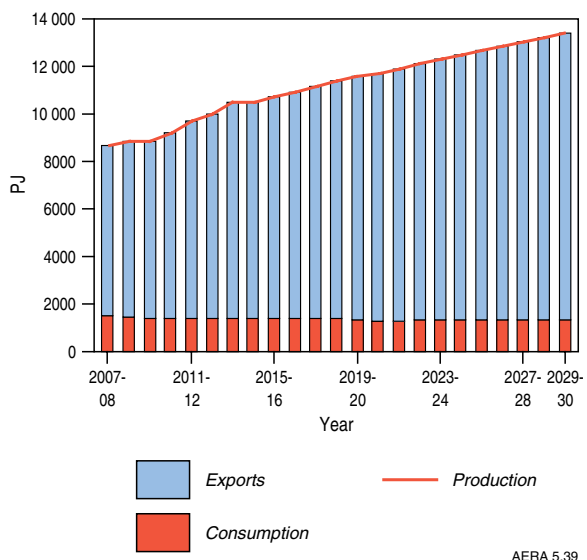
In addition to the projects under construction, there a number of mine and infrastructure projects at a less advanced stages of development, that are either at feasibility study stage, in the process of receiving government approval or not yet subject to a final investment decision.

There are 49 mining projects at a less advanced stage of development, of which 16 are in New South Wales, 32 in Queensland and one in Western Australia (table 5.12). These projects have a potential capacity of over 300 Mt.



**Figure 5.38** Australia's coal-fired electricity generation to 2029–30

Source: IEA 2009b; ABARE 2010



**Figure 5.39** Australia's black coal projected supply-demand balance to 2029–30

Source: ABARE 2010

Expanded infrastructure capacity will be achieved through the completion of seven port and rail projects of which four are in Queensland and three in New South Wales (table 5.13). When complete, Australia's coal export infrastructure capacity could increase by 65 Mt per year. The largest of these projects, in terms of capacity, are the 30 Mt per year Newcastle Coal Infrastructure Group Coal terminal and the 25 Mt per year expansion to the Abbot Point Coal Terminal in Queensland. In terms of infrastructure, there are 18 projects at a less advanced stage, which includes rail and port projects in both New South Wales and Queensland (table 5.14).

Some of the projects at a less advanced stage of development may encounter changes in economic or competitive conditions, or may be targeting the same emerging market opportunities, necessitating rescheduling. In addition, securing finance for project development, even for high quality projects with a high probability of success, is not guaranteed. Despite the uncertainty inherent to projects at these earlier stages of consideration, the significant number of large scale projects at less advanced stages under consideration for development is expected to provide a firm platform for future growth of Australia's coal industry.

**Table 5.11** Coal mines at an advanced stage of development, as at October 2009

Project	Company	Location	Status	Start up	Capacity	Capital Expenditure
Blackwater Creek Diversion	Wesfarmers	200 km W of Rockhampton, Qld	Expansion, under construction	2010	nil (extension of Curragh mine life)	\$130 m
Blakefield South	Xstrata/ Nippon Steel	16 km SW of Singleton, NSW	New project, under construction	2010	nil (replacement for Beltana)	\$375 m
Cameby Downs	Syntech Resources	100 km NE of Dalby, Qld	New project, under construction	2010	1.4 Mt thermal coal	\$250 m
Carborough Downs longwall	Vale	20 km NE of Moranbah, Qld	Expansion, under construction	2011	4.2 Mt coking	US\$330 m (A\$398 m)
Clermont opencut	Rio Tinto	11 km N of Clermont, Qld	New project, under construction	2010	12 Mt thermal (replacing Blair Athol capacity)	US\$1.3 b (A\$1.57 b)
Curragh Mine	Wesfarmers	200 km W of Rockhampton, Qld	Expansion, committed	2011	Increase to 8.5 Mt	\$286 m
Kestrel	Rio Tinto	51 km NE of Emerald, Qld	Expansion, under construction	2012	1.7 Mt coking	US\$991 m (A\$1.19 b)
Mangoola (Anvil Hill opencut)	Xstrata Coal	20 km SW of Muswellbrook, NSW	New project, under construction	2012	8 Mt thermal	\$1 b
Moolarben stage 1	Felix Resources	Near Mudgee, NSW	New project, under construction	2010 (open cut) 2012 (underground)	8 Mt opencut; up to 4 Mt underground (ROM, thermal)	\$405 m (incl coal preparation plant)
Mount Arthur opencut (MAC20)	BHP Billiton	5 km SW of Muswellbrook, NSW	Expansion, under construction	2011	3.5 Mt thermal	US\$260 m (A\$313 m)
Narrabri Coal Project (stage 1)	Whitehaven	20 km SE of Narrabri, NSW	New project, under construction	early 2010	1.5 Mt thermal	\$185 m
New Acland (stage 3)	New Hope Coal	150 km W of Brisbane, Qld	Expansion, under construction	late 2009	0.6 Mt thermal	\$36 m

Source: ABARE 2009e

**Table 5.12** Coal mines at a less advanced stage of development, as at October 2009

Project	Location	Status	Start up	Capacity	Capital Expenditure
Alpha Coal Project	120 km SW of Clermont, Qld	New project, feasibility study under way	2013	30 Mt thermal	\$7.5 b (inc. mine, port and rail)
Ashton South East opencut	14 km NW of Singleton, NSW	Expansion, feasibility study under way	2010	2.4 Mt thermal	\$83 m
Austar underground (Stage 3)	6 km SW of Cessnock, NSW	Expansion, govt approval received	2012–13	3.6 Mt ROM hard coking	\$80 m
Belvedere underground	160 km W of Gladstone, Qld	New project, prefeasibility study under way	2013	9 Mt hard coking	na
Bickham opencut	20 km N of Scone, NSW	New project, EIS under way	2011	2 Mt thermal	\$50–100 m
Boggabri opencut	17 km NE of Boggabri, NSW	Expansion, feasibility study under way	2013	2.8 Mt thermal	11.5 b yen (A\$140 m)
Canning Basin project	150 km SE of Derby, WA	New project, feasibility study under way	2012–13	2 Mt thermal	na
Caval Ridge (Peak Downs expansion)	20 km SW of Moranbah, Qld	Expansion, prefeasibility study under way	2013	5.5 Mt coking	na
Codrilla	62 km SE of Moranbah, Qld	New project, EIS under way	na	3.2 Mt PCI	na
Daunia	25 km SE of Moranbah, Qld	New project, govt approval received	2011	4 Mt coking	na
Dawson South (stage 2)	15 km NW Theodore, Qld	Expansion, EIS under way	na	5–7 Mt thermal (ROM)	na
Drayton mine extension	13 km S of Muswellbrook, NSW	Expansion, feasibility study under way	na	2.5 Mt thermal	\$35 m
Eagle Downs (Peak Downs East underground)	20 km SE of Moranbah, Qld	New project, EIS under way	2014	4.6 Mt coking	\$977 m
Ellensfield coal mine project	175 km W of Mackay, Qld	New project, EIS under way	na	4.5 Mt thermal and coking	na
Ensham bord and pillar underground mine	40 km NE of Emerald, Qld	New project, feasibility study under way	2011	1.5 Mt thermal	\$120 m
Ensham Central longwall underground	40 km NE of Emerald, Qld	Expansion, prefeasibility study under way	na	7 Mt thermal	\$700 m
Goonyella Riverside Expansion	30 km N of Moranbah, Qld	Expansion, prefeasibility study under way	na	up to 9 Mt hard coking	na
Grosvenor underground	8 km N of Moranbah, Qld	New project, EIS under way	2012	6.5 Mt hard coking	US\$850 m (A\$1 b)
Hail Creek expansion	120 km SW of Mackay, Qld	Expansion, prefeasibility study under way	2011	5.5 Mt thermal, 2.5 Mt hard coking	na
Hunter Valley Operations Expansion	24 km N of Singleton, NSW	Expansion, govt approval received	2011	3.6 Mt ROM semi-soft coking and thermal	\$130 m
Intergrated Isaac Plains Project	180 km SW of Mackay, Qld	Expansion, EIS under way	na	2 Mt coking and thermal	\$118 m
Kevin's Corner	Galilee Basin, Qld	New project, feasibility study under way	2013	30 Mt thermal	na
Kunioon	Kingaroy, Qld	New project, on hold	na	10 Mt thermal (ROM)	\$500 m
Lake Vermont	60 Km SE of Moranbah, Qld	Expansion, prefeasibility study under way	2014	2 Mt	\$100–200 m
Metropolitan longwall	30 km N of Wollongong, NSW	Expansion, govt approval received	na	3.2 Mt	\$50 m



Project	Location	Status	Start up	Capacity	Capital Expenditure
Middlemount (stage 1)	6 km SW of Middlemount, Qld	New project, environmental approval received	2010	1.8 Mt coking (ROM)	\$65 m
Middlemount (stage 2)	6 km SW of Middlemount, Qld	New project, feasibility study under way	2012	3.2 Mt coking (ROM)	na
Millennium expansion	22 km E of Moranbah, Qld	Expansion, feasibility study under way	na	8.1 Mt (ROM)	na
Monto coal mine (stage 1)	120 km S of Gladstone, Qld	New project, feasibility completed	na	1.2 Mt thermal	\$35 m
Monto coal mine (stage 2)	120 km S of Gladstone, Qld	Expansion, prefeasibility study under way	na	10 Mt	na
Moolarben (stage 2)	near Mudgee, NSW	Expansion, EIS under way	na	12 Mt opencut; up to 4 Mt underground (ROM, thermal)	\$120 m
Moranbah South project	4 km S of Moranbah, Qld	New project, prefeasibility study under way	2014	6.5 Mt coking	US\$1 b (A\$1.2 b)
Mount Arthur North underground	5 km SW of Muswellbrook, NSW	New project, govt approval received	2011	8 Mt thermal (ROM)	\$320 m
Mount Pleasant Project	6 km NW of Muswellbrook, NSW	New project, feasibility study completed, on hold	2013	10.5 Mt thermal	\$1.3 b
Narrabri Coal Project (stage 2)	20 km SE of Narrabri, NSW	Expansion, feasibility study under way	2011	4.5 Mt thermal	\$300 m
New Acland (stage 4)	150 km W of Brisbane, Qld	Expansion, EIS completed	na	5.2 Mt thermal coal	na
NRE No. 1 Colliery	Wollongong, NSW	Expansion, feasibility study under way	na	3 Mt	\$250 m
Olive Downs North	30 km S of Coppabella, Qld	New project, feasibility study under way	2011	1 Mt coking	na
Red Hill underground	45 km N of Moranbah, Qld	New project, prefeasibility study under way	2014	2 Mt PCI and thermal	na
Saddler's Creek underground and opencut	15 km SW of Muswellbrook, NSW	New project, feasibility study under way	na	2 Mt thermal, 2 Mt coking	na
Ulan	Mudgee, NSW	Expansion, feasibility study under way	2010	nil (continuation of mining operations)	\$500 m
Walarah underground longwall	NW of Wyong, NSW	New project, feasibility study under way	late 2011	5 Mt thermal	\$550 m
Wandoan opencut	60 km N of Miles, Qld	New project, feasibility study under way	2012	up to 22 Mt thermal	US\$1.6 b (A\$1.9 b)
Waratah Galilee coal project	450 km W of Rockhampton, Qld	New project, awaiting govt approval	2013	up to 40 Mt thermal	\$7.5 b
Washpool coal project	260 km W of Rockhampton, Qld	New project, feasibility study under way	2012	1.6 Mt of coking	\$402 m
Winchester South	40 km S of Moranbah, Qld	New project, prefeasibility study under way	2013	4 Mt of coking and thermal	na
Wonbindi	180 km W of Gladstone, Qld	New project, prefeasibility study under way	2013	3 Mt PCI and thermal	na
Wongawilli Colliery	12 km W of Port Kembla, NSW	Expansion, feasibility study under way	na	nil (continuation of mining operations)	\$62 m
Woori	19 km S of Wandoan, Qld	New project, prefeasibility study under way	2013	3–4 Mt thermal coal	na

Source: ABARE 2009e

**Table 5.13** Coal infrastructure at an advanced stage of development, as at October 2009

Project	Company	Location	Status	Start up	Capacity	Capital Expenditure
Abbot Point Coal Terminal X50 expansion	North Queensland Bulk Ports	Bowen, Qld	Expansion, committed	mid 2011	Terminal capacity increase from 25 to 50 Mtpa	\$818 m
Abbot Point Coal Terminal yard refurbishment	North Queensland Bulk Ports	Bowen, Qld	Refurbishment, committed	mid 2011	na	\$68 m
Brisbane Coal Terminal expansion	Queensland Bulk Handling	Brisbane, Qld	Expansion, under construction	2010	1 Mtpa	\$10 m
Coppabella to Ingsdon rail duplication	Queensland Rail	Coppabella to Ingsdon, Qld	Expansion, committed	mid 2010	3 Mtpa	\$80 m
Minimbah Bank Third Rail Line (stage 1)	Australian Rail and Track Corporation	Minimbah to Whittingham (10km), NSW	Expansion, under construction	2010	na	\$134 m
NCIG export terminal (Newcastle Coal Infrastructure Group)	NCIG	Newcastle, NSW	New project, under construction	2010	Capacity of 30 Mtpa initially; ultimately 66 Mtpa	US\$1.1 b (A\$1.3 b)

Source: ABARE 2009e

**Table 5.14** Coal infrastructure at a less advanced stage of development, as at October 2009

Project	Company	Location	Status	Start up	Capacity	Capital Expenditure
2 Export Terminal Arrival Tracks	Australian Rail and Track Corporation	Newcastle, NSW	Expansion, feasibility study under way	2011	na	\$50 m
Koolbury – Aberdeen duplication	Australian Rail and Track Corporation	Koolbury – Aberdeen, NSW	Expansion, feasibility study under way	2013	na	\$60 m
Kooragang Island coal terminal expansion	Port Waratah Coal Services	Newcastle, NSW	Expansion, feasibility study under way	na	Capacity increase to be decided	To be decided
Liverpool Range rail project	Australian Rail and Track Corporation	Willow Tree to Murrurundi (30 km), NSW	Expansion, feasibility study under way	2012	Capacity increase of 12.5 Mt	\$290 m
Minimbah Bank Third Rail Line (stage 2)	Australian Rail and Track Corporation	Maitland to Minimbah (32 km), NSW	Expansion, planning approval under way	2012	na	\$300 m
Nundah Bank 3rd Road (rail)	Australian Rail and Track Corporation	Minimbah to Maitland (30 km), NSW	Expansion, feasibility study under way	2012	na	\$125 m
Scone – Parkville Duplication	Australian Rail and Track Corporation	Scone – Parkville, NSW	Expansion, feasibility study under way	2013	na	\$60 m
Western Rail Coal Unloader	Delta Electricity	Mt Piper, 10 km W of Lithgow, NSW	New project, govt approval received	2012	8 Mt (ultimately)	\$80 m
Abbot Point Coal Terminal X110 expansion	North Queensland Bulk Ports	Bowen, Qld	Expansion, EIS submitted, on hold	2014	Terminal capacity increase from 80 to 110 Mtpa	\$1.8 b
Abbot Point Coal Terminal X80 expansion	North Queensland Bulk Ports	Bowen, Qld	Expansion, EIS submitted, on hold	2012	Terminal capacity increase from 50 to 75 Mtpa	\$1.8 b
Balaclava Island coal terminal	Xstrata	50 km N of Gladstone, Qld	New project, EIS under way	2014	35 Mtpa	\$1 b

Project	Company	Location	Status	Start up	Capacity	Capital Expenditure
Goonyella to Abbot Pt (rail) (X50)	Queensland Rail	North Goonyella to Newlands (70 km), Qld	Expansion, final stages of planning	early 2012	50 Mtpa	\$1.1 b
Hay Point Coal Terminal Phase 3	BHP Billiton Mitsubishi Alliance (BMA)	20 km S of Mackay, Qld	Expansion, feasibility study under way	2014	Port capacity increase from 44 to 55 Mtpa	\$500 m
Moura Link – Aldoga Rail	Queensland Rail	Moura/Surat to Mount Larcom, Qld	New project, EIS completed	mid 2013	na	\$500 m
Surat Basin Rail (Southern Missing Link)	Queensland Rail/ ATECDV/ Xstrata Coal	Wandoan to Theodore (210 km), Qld	New project, EIS submitted	2012	42 Mtpa haulage capacity ultimately	\$1 b
Wiggins Island Coal Terminal (stage 1)	Wiggins Island Coal Export Terminal	Gladstone, Qld	New project, EIS under way	2012	25 Mtpa	\$1.4 b
Wiggins Island Coal Terminal (stage 2)	Wiggins Island Coal Export Terminal	Gladstone, Qld	New project, EIS under way	2016	Terminal capacity increase from 25 to 50 Mtpa	\$1.4 b
Wiggins Island Coal Terminal (stage 3)	Wiggins Island Coal Export Terminal	Gladstone, Qld	New project, EIS under way	2020	Terminal capacity increase from 50 to 70 Mtpa	\$1 b

Source: ABARE 2009e

**Table 5.15** Coal-fired electricity projects at various stages of development, as at October 2009

Project	Company	Location	Status	Start up	Capacity	Capital Expenditure
<b>Advanced Projects</b>						
<b>Black coal</b>						
Bluewaters stage 2	Griffin Energy	5 km NE of Collie, WA	Under construction	late 2009	208 MW	\$400 m
Eraring	Eraring Energy	40 km SW of Newcastle, NSW	Committed	2011	240 MW	\$245 m
<b>Less Advanced Projects</b>						
<b>Black coal</b>						
Bluewaters stages 3 and 4	Griffin Energy	5 km NE of Collie, WA	EIS under way	2014	416 MW	na
Coolimba	Aviva Corporation	20 km S of Eneabba, WA	EIS under way	2013	400 MW	\$1 b
Wandoan Power Project	Xstrata/GE Energy	Surat Basin, Qld	Prefeasibility study under way	2015-16	400 MW	na
ZeroGen stage 1 (demonstration phase)	ZeroGen Pty Ltd	Rockhampton, Qld	Feasibility study under way	2012	120 MW	\$1.7 b
ZeroGen stage 2 (commercial phase)	ZeroGen Pty Ltd	to be determined, Qld	Prefeasibility study under way	2017	400 MW	\$3 b
Arckaringa Phases 1 & 2	Altona Resources	200 km N of Coober Pedy, SA	New project, feasibility study under way	2014	560 MW	\$520 m
Arckaringa Phase 3	Altona Resources	200 km N of Coober Pedy, SA	New project, feasibility study under way	na	280MW	na

Project	Company	Location	Status	Start up	Capacity	Capital Expenditure
<b>Brown coal</b>						
FuturGas project	Strike Oil	Kingston, SA	Prefeasibility study under way	2016	40 MW	na
HRL IDGCC project	HRL Technology/Harbin	Latrobe Valley, Vic	Feasibility study under way	2013	400 MW	\$750 m

Source: ABARE 2009f

## 5.5 References

ABARE (Australian Bureau of Agricultural and Resource Economics), 2009a, Australian Energy Statistics, Canberra, August

ABARE, 2009b, Australian Mineral Statistics, Canberra, September

ABARE, 2009c, Australian Commodities, Canberra, September

ABARE, 2009d, Australian Commodity Statistics, Canberra, December

ABARE, 2009e, Minerals and energy major projects – October 2008 listing, Canberra, November

ABARE, 2009f, Electricity generation: major development projects – October 2009 listing, Canberra, November

ABARE, 2010, Australian energy projections to 2029–30, ABARE research report 10.02, prepared for the Department of Resources, Energy and Tourism, Canberra

Australian Bureau of Statistics (ABS), 2009, Mineral and Petroleum Exploration, Australia, catalogue no. 8412.0, Canberra, September

Australian Coal Association (ACA), 2009, Coal and its uses, <<http://www.australiancoal.com.au/coal-and-its-uses.aspx>>

APCRC (Australian Petroleum Cooperative Research Centre), 2003, GEODISC project (1999–2003)

BP, 2009, Statistical Review of World Energy, London

Carbon Storage Taskforce, 2009, National Carbon Mapping and Infrastructure Plan – Australia: Concise Report, Department of Resources, Energy and Tourism, Canberra

Coal-to-Liquids Coalition, (n.d.), Technology: the technology behind CTL, <<http://www.futurecoalfuels.org/technology.asp>>

CSIRO, 2009, Review of energy conversion technologies. Draft report to Department of Resources, Energy and Tourism, July

Daniel R, 2006, CO<sub>2</sub> seal capacity comparisons from selected geological storage sites in Australia, APPEA Conference Poster

DCC (Department of Climate Change), 2009, Australia's national greenhouse gas accounts, May 2009, <<http://www.climatechange.gov.au/climate-change/~media/>>

publications/greenhouse-report/national-greenhouse-gas-inventory-pdf.ashx>

Ekawan R, Duchene M and Goetz D, 2006, The Evolution of Hard Coal Trade in the Pacific Market, Energy Policy, 34, 1853–1866

Geoscience Australia, 2008, Geological storage of carbon dioxide fact sheet, <[http://www.ga.gov.au/image\\_cache/GA12133.pdf](http://www.ga.gov.au/image_cache/GA12133.pdf)>

Geoscience Australia, 2009, Australia's Identified Mineral Resources, 2009. Geoscience Australia, Canberra, <<http://www.australianminesatlas.gov.au/aimr/index.jsp>>

Gibson-Poole CM, Lang SC, Streit JE, Kraishan GM and Hillis RR, 2002, Assessing a basin's potential for geological sequestration of carbon dioxide: an example from the Mesozoic of the Petrel Sub-basin, NW Australia. The Sedimentary Basins of Western Australia 3. Proceedings of the PESA Symposium 2002, 439–463

IEA, 2009a, Coal Information database, 2009, Paris

IEA, 2009b, World Energy Balances, 2009, Paris

IEA, 2009c, World Energy Outlook, OECD/IEA, Paris

Linc Energy, 2009, UCG, Linc Energy, Brisbane, <<http://www.lincenergy.com.au/ucg.php>>

Metal Bulletin, 2008, Trading Iron Ore — a full feasibility study for a new derivatives contract 2008, Metal Bulletin, London

RET (Department of Resources, Energy and Tourism), 2009, Clean Energy Technologies, <<http://www.ret.gov.au/energy/Pages/index.aspx>>

Sinclair Knight Mertz (SKM), 2009, Reducing Carbon Emissions from Thermal Power Stations. Achieve, <<http://www.skmconsulting.com/Knowledge-and-Insights/Achieve-Articles/2009/2009-reducing-carbon-thermal-power-stations.aspx>>

World Coal Institute, 2009, Where is coal found?, World Coal Institute, <<http://www.worldcoal.org/coal/where-is-coal-found/>>

World Coal to Liquids (CTL) Association, 2009, Coal-to-liquids: a global outlook, presentation, <<http://www.worldctl2009.com/general.html>>

World Energy Council, 2007, 2007 Survey of energy resources, World Energy Council, London, United Kingdom

# Chapter 6

## Uranium and Thorium



### 6.1 Summary

#### KEY MESSAGES

- Australia has the world's largest Reasonably Assured Resources of uranium and identified recoverable thorium resources.
- Australia is the world's third largest producer of uranium. At present, there is no thorium production.
- Currently Australia has three uranium mines operating, with two additional operations scheduled to begin production in 2010.
- World demand for uranium is projected to increase strongly over the next 20 years as new nuclear capacity is commissioned.
- Australia's uranium production is forecast to more than double by 2030.
- There are currently no plans for Australia to have a domestic nuclear power industry by 2030.
- In the longer term there is potential for thorium-fuelled reactors, but currently there are no commercial scale thorium-fuelled reactors anywhere in the world.

#### 6.1.1 World uranium and thorium resources and market

- Uranium and thorium can be used as nuclear reactor fuel. Uranium is currently the preferred fuel; thorium may be a future fuel.
- World Reasonably Assured Resources (RAR) recoverable at less than US\$80/kg of uranium are estimated to be around 3047 kilotonnes (kt U) at the end of 2008. This is equal to about 50 years of current nuclear reactor consumption levels.
- World uranium mine production has increased by an average 2.8 per cent per year since 2000, reaching 24 584 PJ (43.9 kt U) in 2008.
- Secondary supplies of uranium from blended highly enriched uranium (HEU), government stocks and mixed oxide fuels accounted for around 32 per cent of global uranium supply in 2008. This compares with 44 per cent in 2000.
- World uranium consumption has increased by 1.5 per cent per year since 2000, reaching 36 176 PJ (64.6 kt U) in 2008. Nuclear power accounted for 6.2 per cent of global primary energy consumption and 14.8 per cent of world electricity generation in 2007.
- World demand for uranium is projected to increase at 3.7 per cent per year to 2030, reflecting the commissioning of new nuclear

capacity worldwide. Generation III reactors incorporate advanced safety systems and have improved fuel technologies; Generation IV reactors, currently in research and development, will utilise uranium more efficiently, minimise waste and be proliferation resistant.

- Thorium based fuels could be used in some existing uranium-fuelled reactors possibly in the medium term, but full scale commercial thorium-fuelled reactors are not likely before 2030.

#### 6.1.2 Australia's uranium and thorium resources

- Australia has the world's largest RAR recoverable at less than US\$80/kg of uranium (US\$80/kg U) with 1163 kt in this category at December 2008. The estimated RAR for 2008 will last about 140 years at current Australian production levels.
- Australia has substantial potential for the discovery of new uranium resources.
- New pre-competitive data released by Geoscience Australia – notably the radiometric map of Australia and database – are providing a further stimulus to uranium exploration and discovery.
- Australia has a major share of the world's thorium resources. Estimated total recoverable Identified Resources of thorium could amount to about 490 kt.



- There is currently no exploration specifically focused on thorium. All of the information available on thorium resources has been generated by exploration and mining activities aimed principally at other mineral commodities.

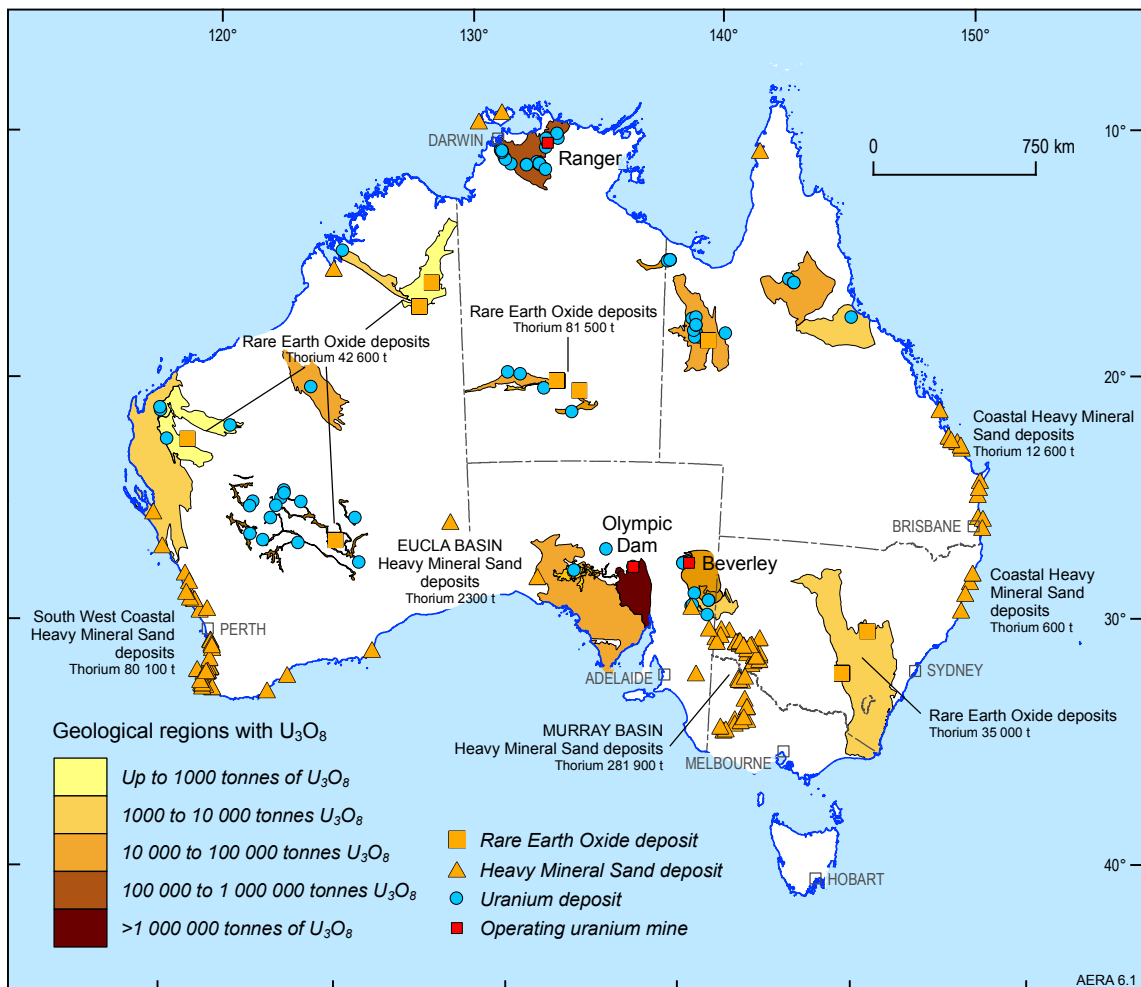
### 6.1.3 Key factors in utilising Australia's uranium and thorium resources

- There is renewed interest worldwide in nuclear power and hence demand for uranium is expected to increase.
- Successful exploration and development of uranium deposits is dependent on several factors including state government policy, prices, production costs, ability to demonstrate best practice environmental and safety standards, and community acceptance of uranium development.
- Limited commercially viable transport options and restriction of access to two ports may limit expansion of Australian uranium exports. A reduced number of shipping firms and routes that accept uranium may result in further delays and costs.

- Global demand for thorium is dependent upon the development of widespread commercial scale thorium-fuelled reactors for electricity generation.
- There has been renewed interest in development of thorium-fuelled reactors. This is partly because of greater abundance of thorium resources in some countries, greater resistance to nuclear weapons proliferation, and a substantial reduction in radioactive waste generated.

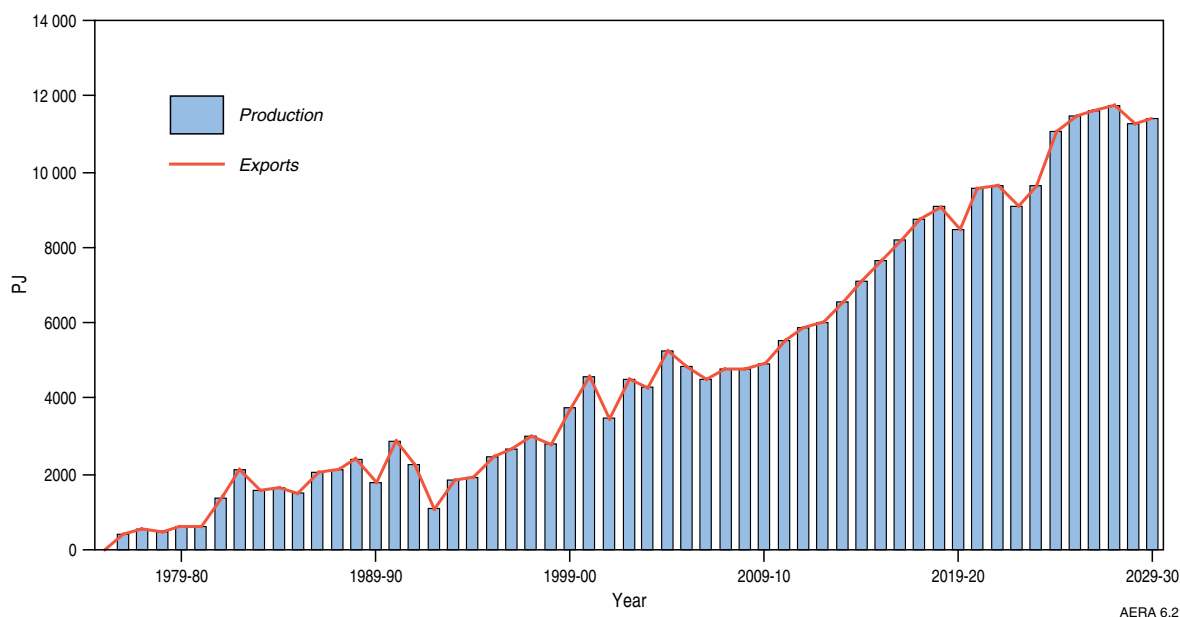
### 6.1.4 Australia's uranium and thorium market

- Australia has three operating uranium mines: Ranger open pit mine in the Northern Territory, Olympic Dam underground mine and Beverley in situ recovery (ISR) mine in South Australia (figure 6.1). Two more ISR mines, Four Mile and Honeymoon in South Australia, are expected to be producing in 2010.
- Australia has been a reliable producer of uranium since the early 1950s. Australia's uranium oxide production in 2008–09 was 4872 PJ (8.7 kt U). Australia is the third largest uranium producer with 19.2 per cent of world production.



**Figure 6.1** Australia's total identified uranium and thorium resources, 2008

Source: Geoscience Australia



**Figure 6.2** Australia's projected uranium supply-demand balance to 2029–30

Source: ABARE

- Australia does not consume any of its domestic uranium production. In 2008–09, Australia exported 4816 PJ (8.6 kt U) with an export value of A\$1033 million. Australia's major export destinations are the United States, Japan and France.
- Australian production of uranium oxide is projected to increase by an average 6 per cent per year to reach 11 480 PJ (20.5 kt U) by 2029–30 (figure 6.2). All production is expected to be exported.
- Australian production and subsequent trade of thorium is not likely to occur on a large scale before 2030.
- If commercialisation of a thorium fuel cycle occurs more quickly than assumed, Australia is well positioned to supply world markets with low cost reliable sources of thorium. Currently, thorium is being diluted and disposed of at the mineral sand mine site, making these resources uneconomic to recover in the future.

**Enriched uranium** is uranium with an enhanced concentration of the  $U^{235}$  isotope, up from 0.7 per cent to between 3 and 5 per cent. Uranium is required to undergo enrichment for use in most civilian nuclear reactors. Like all thermal power plants, nuclear reactors work by generating heat, which boils water to produce steam to drive turbines that generate electricity. In nuclear reactors, the heat is produced from nuclear fission of  $U^{235}$ . Highly enriched uranium (HEU) is enriched to 20 per cent or more  $U^{235}$  and weapons-grade HEU is enriched to over 90 per cent.

**Secondary sources** arise from the reprocessing of spent nuclear fuel, blended down HEU from nuclear weapons, or mixed oxide fuels. Currently, secondary sources supply a significant portion of uranium demand for nuclear reactors.

### Uranium supply chain

A conceptual representation of the Australian uranium supply chain is given in figure 6.3. The supply chain is divided into four distinct phases: resources exploration; development and production; processing, transport and storage; and end use markets. Australia's supply chain concludes with the exporting of uranium oxide to countries for processing, enrichment and use in nuclear power plants.

#### Resources exploration

There is a wide variety of geological settings that result in the formation of different types of uranium deposits. The main areas of exploration activities in Australia are:

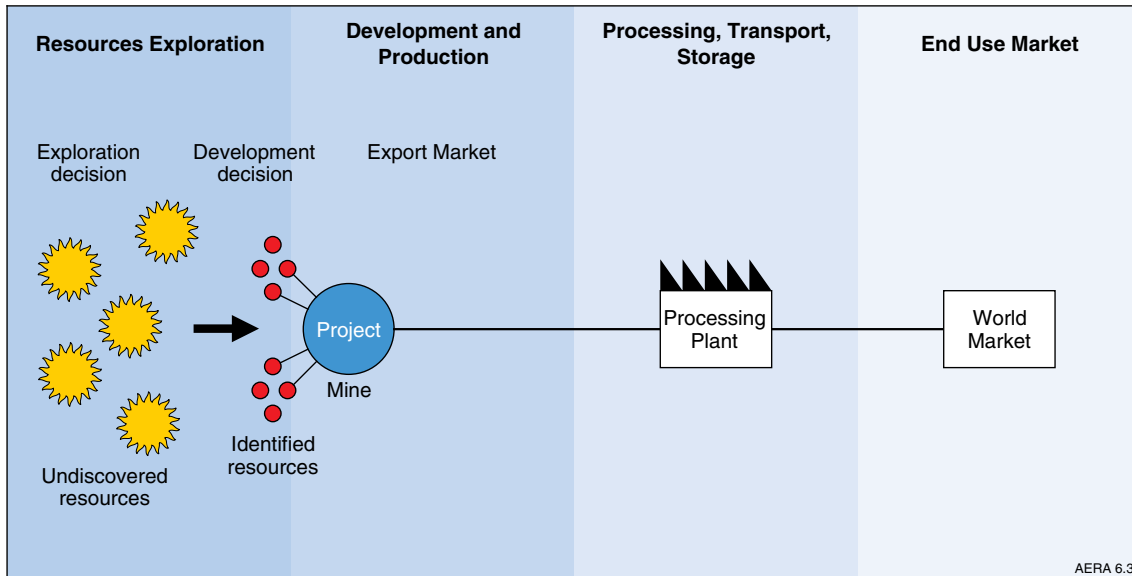
- Gawler Craton/Stuart Shelf region (hematite breccia deposits) and Frome Embayment (sandstone deposits) in South Australia,

## 6.2 Uranium

### 6.2.1 Background information and world market

#### Definitions

**Uranium (U)** is a mildly radioactive element that is widespread at levels of one to four parts per million (ppm) in the Earth's crust. Concentrations of uranium rich minerals, such as uraninite, carnotite and brannerite can form economically recoverable deposits. Once mined, uranium is processed into uranium oxide ( $U_3O_8$ ), also referred to as uranium oxide concentrate (UOC) and is exported in this form. Natural uranium (mine production) contains about 0.7 per cent of the uranium isotope  $U^{235}$  and 99.3 per cent  $U^{238}$ .



**Figure 6.3** Australia's uranium supply chain

Source: ABARE and Geoscience Australia

- Paterson Province (unconformity type deposits) and Yilgarn Craton (calcrete type deposits) in Western Australia,
- Pine Creek and Arnhem Land regions (unconformity type deposits) in Northern Territory, and
- Mt Isa region in Queensland (metasomatite type deposits).

Exploration activities use geological and geophysical methods to locate and delineate potential uranium deposits. A deposit is systematically drilled and assayed to quantify the grade and tonnage of the deposit. The different types of deposits have a wide range of ore grades, tonnage and ore minerals.

South Australia and Northern Territory maintain the bulk of exploration activity. Uranium exploration and mining are prohibited in New South Wales and Victoria. Queensland has uranium resources, and previously mined uranium, but currently has a policy of no uranium mining. In late 2008, Western Australia removed its six year ban on uranium mining, which has resulted in renewed investment in uranium projects.

#### *Development and production*

Once a resource has been quantified, a company makes a decision on whether to proceed with development based on underlying market conditions, including commodity prices and the ability to finance the project. If a decision to proceed with the project is made, construction of a mine site and processing facilities begins after approval by Australian and state/territory governments.

In Australia, uranium is recovered using both conventional and ISR mining techniques. Most of Australia's uranium production is from conventional

(open cut or underground) mining techniques, followed by milling and metallurgical processing. There is currently only one ISR mine, but several more are expected to begin production in the short term. ISR mining is widely used in Kazakhstan and United States and accounts for about 28 per cent of global uranium mine production. The process involves recovering uranium without removing the ore body from the ground. Uranium is extracted by means of an acid or alkaline solution which is pumped down injection wells into the permeable mineralised zone to remobilise uranium from the ore body. The uranium bearing solution is pumped to the surface and recovered in a processing plant.

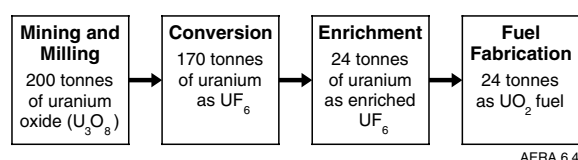
#### *Processing, transport and storage*

Conventionally extracted uranium is milled, and then processed to produce  $U_3O_8$ . For ISR mining, the uranium-bearing solution is pumped to a processing plant and treated in much the same way as conventional uranium operations. The  $U_3O_8$  is not directly usable as a fuel for a nuclear power reactor and additional processing (conversion and enrichment) and fuel fabrication are required.

The processing path and amount of uranium required annually by a 1000 megawatt electric (MWe) light water reactor is illustrated in figure 6.4. The  $U_3O_8$  is converted into uranium hexafluoride ( $UF_6$ ), which is then enriched to increase the proportion of uranium isotope  $U^{235}$  from 0.7 per cent to between 3 and 5 percent. The enriched  $UF_6$  is converted to uranium dioxide ( $UO_2$ ) and transferred to a fabrication plant. Solid ceramic pellets containing  $UO_2$  are encased in metal tubes to form fuel rods used in the nuclear reactor. Typically, one tonne of uranium will produce 44 gigawatt hours of electricity (WNA 2009a).

Each stage of the fuel cycle produces some radioactive waste, which is disposed of using proven technologies. International conventions such as the *Joint Convention on Nuclear Safety* and the *Joint Convention on the Safety of Spent Fuel Management and on the Safety of Radioactive Waste Management*, assert that the ultimate responsibility for ensuring the safety of spent fuel and radioactive waste management rests with the state.

In the Australian uranium supply chain, uranium mining generates tailings, the radioactivity of which is low and is managed by disposal in site-specific engineered tailings dams. The Australian regulatory regime requires mines to be approved subject to best practice environmental and safety standards.



**Figure 6.4** Typical annual quantity of uranium required for a 1000 MWe nuclear reactor

Source: Commonwealth of Australia 2006a

#### End use market

Australia does not have a domestic nuclear power industry; all of Australia's uranium production is exported. Australia has stringent requirements for the supply of uranium and nuclear material derived from it. Receiving states must be a party to and comply with the Treaty on the Non-Proliferation of Nuclear Weapons, have a bilateral safeguards agreement

with Australia and, in the case of non-nuclear weapon states, have an Additional Protocol, which ensures the International Atomic Energy Agency (IAEA) has access to and inspection rights in the recipient country. These requirements apply also to third party states that may be involved in processing and transshipment of the material.

Australian uranium producers sell most of their production through long term contracts. Only a small amount of Australian uranium is sold on the world spot market.

At present  $U_3O_8$  is exported through the Adelaide and Darwin container ports only. The  $U_3O_8$  is shipped to international end use markets, either directly or through countries which convert and enrich the  $U_3O_8$  and fabricate fuel. The uranium fuel is used in civilian nuclear power reactors to generate electricity, and in the manufacture of radioisotopes for medical applications.

#### World uranium market

Table 6.1 provides a snapshot of the Australian uranium market in a global context. Australia has the world's largest uranium resources and is the third largest producer in the world.

#### Resources

Uranium resources are categorised using the OECD Nuclear Energy Agency (OECD/NEA) and the IAEA classification scheme. The uranium resource estimates are for recoverable uranium, which deducts losses due to mining and milling. Uranium recoverable at less than US\$80/kg U is considered to be economic at current market prices.

**Table 6.1** Key uranium statistics, 2008

	unit	Australia	OECD <sup>b</sup>	World
<b>Resources<sup>a</sup></b>	PJ	651 280	902 720	1 706 320
	kt U	1163	1612	3047
Share of world	%	38.2	52.9	100.0
World ranking	no.	1	-	-
<b>Production</b>	PJ	4760	10 696	24 584
	kt U	8.5	19.1	43.9
Share of world	%	19.2	43.6	100.0
World ranking	no.	3	-	-
Annual average growth of production 2000–08	%	1.4	-1.0	2.8
<b>Consumption<sup>c</sup></b>	PJ	0	30 408	36 176
	kt U	0	54.3	64.6
Annual average growth of consumption 2000–08	%	-	0.1	1.5
Nuclear share of primary energy consumption	%	0	10.9	6.2 <sup>d</sup>
Nuclear share of electricity generation	%	0	21.2	14.8 <sup>d</sup>

<sup>a</sup> Reasonably assured resources recoverable at <US\$80/kg U. Data for Australia compiled by Geoscience Australia and estimates for other countries are from OECD/NEA-IAEA. <sup>b</sup> ABARE estimates. <sup>c</sup> Amount of uranium used in nuclear power plants. <sup>d</sup> 2007 data

Source: OECD/NEA-IAEA 2008, Geoscience Australia 2009, WNA 2009b, IEA 2009, ABARE 2009a

World total Identified Resources (RAR and Inferred Resources) recoverable at less than US\$80/kg U were estimated to be 2.7 million PJ (4.85 million tonnes U) at December 2008 (OECD/NEA-IAEA 2008, Geoscience Australia 2009). At current rates of world consumption for energy purposes this is enough to supply approximately 75 years.

At December 2008, Australia's total Identified Resources (RAR and Inferred) recoverable at less than US\$80/kg U accounted for 33 per cent of global resources (table 6.2). Other countries with large resources include Kazakhstan (16 per cent), the Russian Federation (10 per cent), Canada (9 per cent) and South Africa (7 per cent).

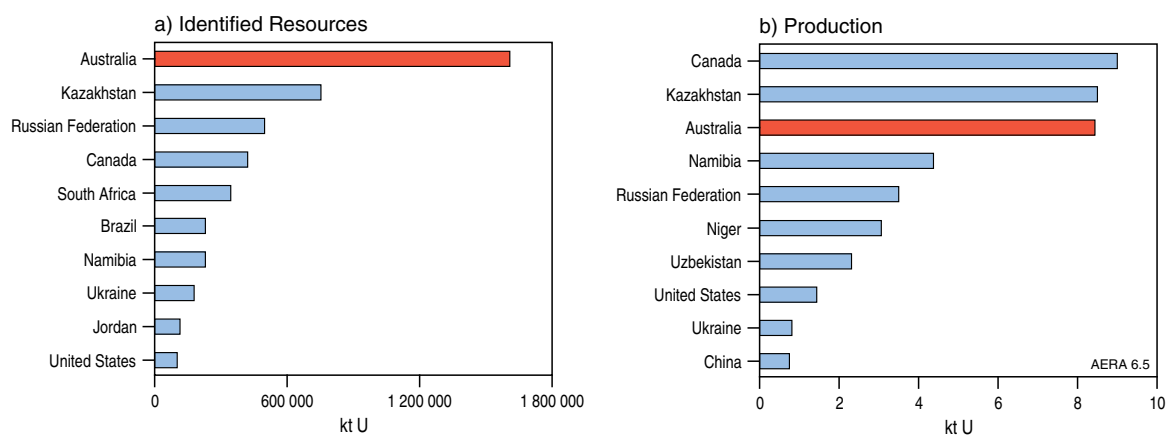
### Mine production

Uranium production is focused in a small number of countries. In 2008, world uranium production was 24 584 PJ (43.9 kt U) with Canada (20.5 per cent), Kazakhstan (19.4 per cent), Australia (19.2 per cent), and Namibia (10 per cent) accounting for nearly 70 per cent of this production (WNA 2009b; see figure 6.5). Australia was the world's second largest uranium producer from the mid-1990s through to 2007. Kazakhstan production has increased rapidly in recent years and in 2008 its production exceeded Australian production for the first time (WNA 2009b).

**Table 6.2** World total Identified Resources of uranium recoverable at less than US\$80/kg U, 2008

	Identified Resources (RAR & Inferred) <US\$80/kg U		Reasonably Assured Resources (RAR) <US\$80/kg U	
	kt U	Share of world %	kt U	Share of world %
Australia	1612.7	33.2	1163.3	38.2
Kazakhstan	751.6	15.5	344.2	11.3
Russian Federation	495.4	10.2	172.4	5.7
Canada	423.2	8.7	329.2	10.8
South Africa	343.2	7.1	205.9	6.7
Brazil	231.0	4.8	157.4	5.2
Namibia	230.3	4.7	145.1	4.8
Ukraine	184.1	3.8	126.5	4.1
Jordan	111.8	2.3	44.0	1.4
United States	99.0	2.0	99.0	3.3
Uzbekistan	86.2	1.8	55.2	1.8
Other	284.6	5.9	205.1	6.7
<b>Total</b>	<b>4853.1</b>	<b>100.0</b>	<b>3047.3</b>	<b>100</b>

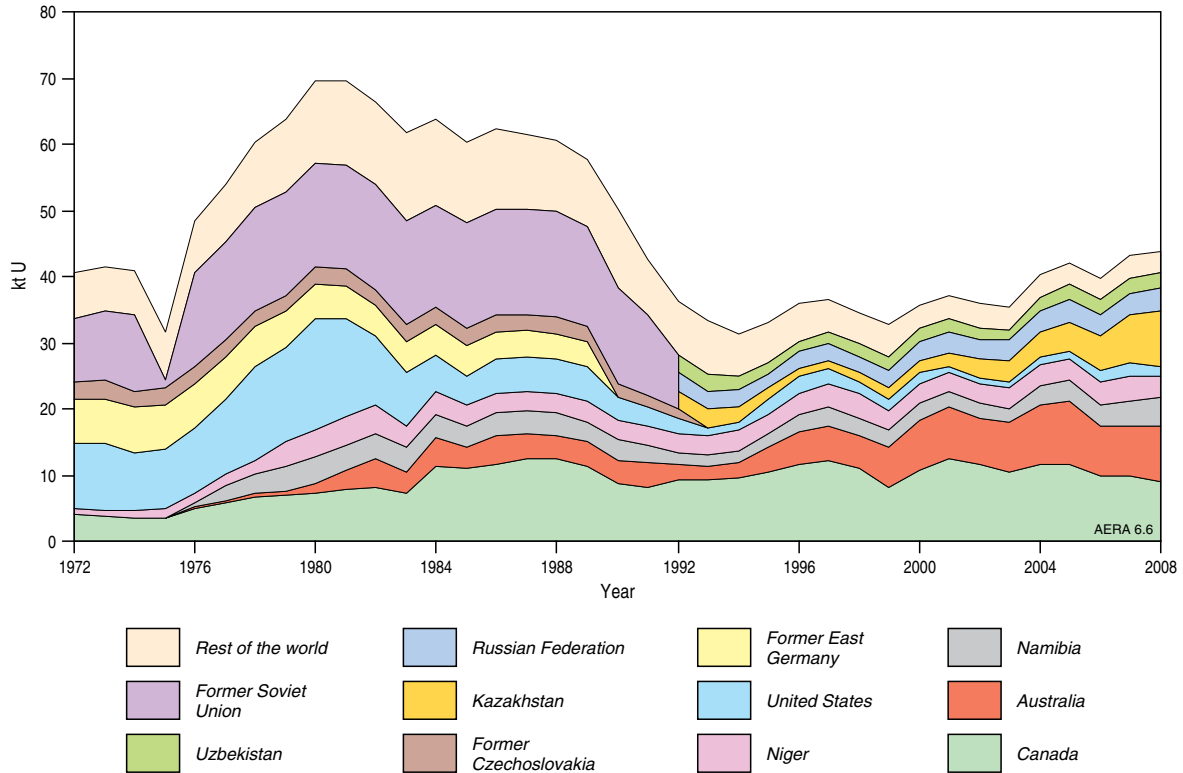
**Source:** Data for Australia compiled by Geoscience Australia and estimates for other countries are from OECD/NEA-IAEA. Figures are rounded to the nearest 100 tonnes



**Figure 6.5** World uranium resources and production, by major country, 2008

**Source:** OECD/NEA-IAEA 2006, 2008; WNA 2009b





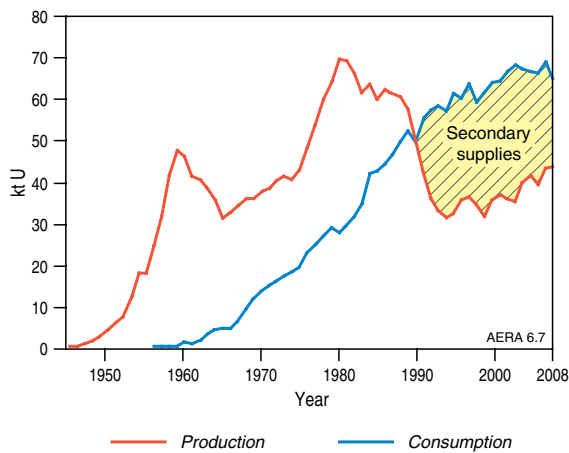
**Figure 6.6** World uranium production, by major producer  
 Source: OECD/NEA-IAEA 2006, 2008

World uranium production peaked at 39 032 PJ (69.7 kt U) in 1980, reflecting strong demand for uranium in non-energy uses and increasing penetration of nuclear power (figure 6.6). At peak production, the largest uranium producers were the former Soviet Union, United States, Canada and East Germany. Since 1980, production in most of these countries has declined as a result of secondary sources entering the market, driving down prices and increasing competition and pressure on high cost producers. World uranium production reached

a low of 17 640 PJ (31.5 kt U) in 1994. Since then, uranium production has increased steadily, reflecting higher production in countries such as Australia, Kazakhstan and Namibia.

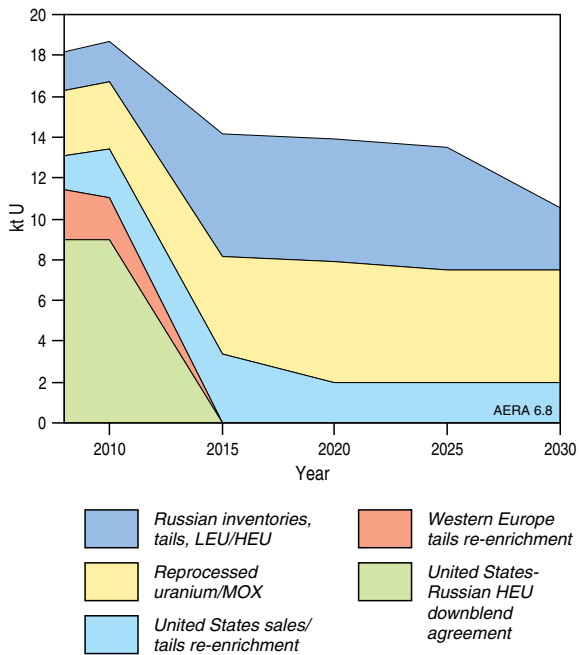
**Secondary supply**

Uranium production consistently exceeded requirements for energy purposes until 1989 (figure 6.7). Since 1990, global uranium demand for energy purposes has exceeded mine production, with the shortfall met from secondary supply sources.



**Figure 6.7** World uranium production and consumption for energy purposes  
 Source: OECD/NEA-IAEA 2006, 2008, WNA 2009b, 2009c

Secondary sources include low enriched uranium (LEU) produced by blending down highly enriched uranium (HEU) from military stockpiles, mixed oxide fuels (MOX), depleted uranium tails from enrichment plants and government stocks (figure 6.8). Of these, the largest source currently is from military stockpiles of HEU, which are being progressively reduced under the terms of a number of international agreements, such as the United States-Russian Federation HEU purchase agreement and the HEU feed deal. The terms of these agreements will be complete after 2013, at which time there will be a consequent sharp reduction in uranium supply from secondary sources. The Euratom Supply Agency (2009) has forecast that secondary supplies could decline to around 10 kt U per year by 2030. Figure 6.8 illustrates a reference case which incorporates these factors, and assumes also no net changes in inventories and broadly constant supplies from government stocks over the



**Figure 6.8** Sources of secondary supply in the world uranium market, projections to 2030

**Source:** Geoscience Australia, based on data provided by WNA 2009

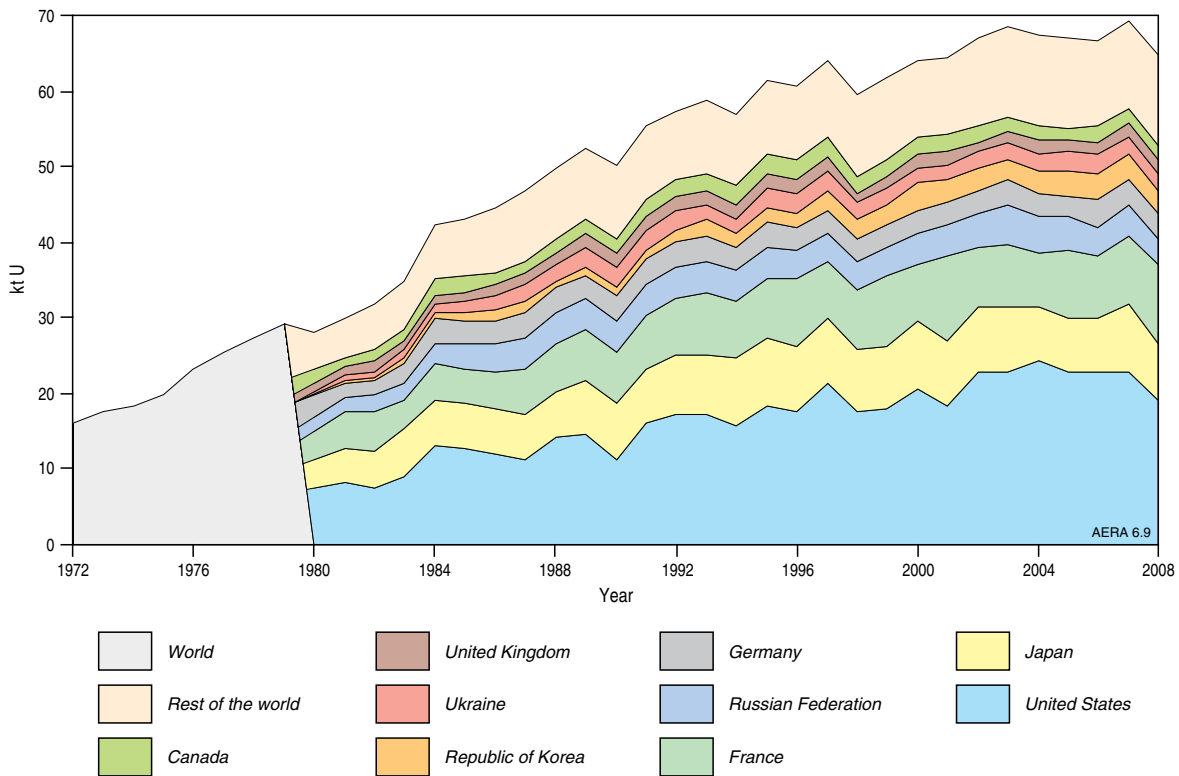
period 2015-2025 and a decline in Russian supply after that time.

MOX is formed by mixing plutonium oxide and depleted uranium oxide. MOX is considered a viable fuel option, and is expected to be used in 15 per cent of world reactors by 2010 (Euratom Supply Agency 2009).

### Consumption

Uranium is used as a fuel for nuclear power and to produce medical and industrial isotopes. The nuclear power industry requirements dominate.

Between 1971 and 2008, uranium consumption for energy purposes grew by an average 4 per cent per year to 36 176 PJ, or 6 per cent of the world's primary energy consumption (IEA 2009). In 2008, the largest consumers of uranium for power generation were the United States, France and Japan (figure 6.9). During the 1990s growth in uranium demand slowed as fewer reactors were built compared with the previous two decades. However, an increased focus on energy diversification and the need to reduce global greenhouse gas (especially carbon dioxide) emissions in recent years has stimulated renewed interest in nuclear power as a proven base load power source and low emission technology.



**Figure 6.9** World uranium consumption for energy generation, by major country

**Source:** OECD/NEA-IAEA 2006, 2008, WNA 2009c

### Trade

With the exception of Canada, uranium production is focused in countries without significant enrichment and conversion facilities, such as Australia, Kazakhstan, Namibia and Niger. Reflecting this, trade in  $U_3O_8$  is common, although information on world trade is often not publicly available due to commercial sensitivities. Based on production and consumption, the largest importers of  $U_3O_8$  in 2008 were likely to have been the United States, Japan, France, Germany and the Republic of Korea. The largest exporters of uranium were likely to have been Australia, Kazakhstan, Canada, Namibia and Niger.

### World outlook for the uranium market to 2030

According to projections from the Energy Information Administration (EIA), world electricity generation from nuclear power is expected to increase by at least 45 per cent to 3844 TWh or 13 838 PJ by 2030 (table 6.3; EIA 2009a). Growth in nuclear power is driven by concerns over increasing demand for electricity, rising fossil fuel prices, energy security, and greenhouse gas emissions. Despite this growth, the share of nuclear power as a proportion of world electricity generation is projected to decrease, from 15 per cent in 2007 to 12 per cent in 2030 (EIA 2009a).

Key growth markets for nuclear power are projected to be developing economies, where electricity consumption will increase significantly over the next 20 years. Countries with the largest growth in nuclear power capacity are expected to be China and India where growing energy demand and favourable nuclear power policies are expected to drive growth. Nevertheless, growth in non-OECD Europe, Eurasia and North America are also likely to play a role in increasing nuclear power production as these economies maintain nuclear power electricity generation in their energy portfolios.

Strong projected growth in nuclear power generation implies a positive outlook for future uranium demand. Based on EIA projections of world nuclear electricity generation, ABARE has estimated future uranium consumption by region (figure 6.10). Global uranium consumption is projected to increase by an average 3.7 per cent per year to reach 104 kt U (58 240 PJ) by 2030. Non-OECD Asian economies are projected to account for most of this growth, mainly reflecting expansions to generating capacity in China and India.

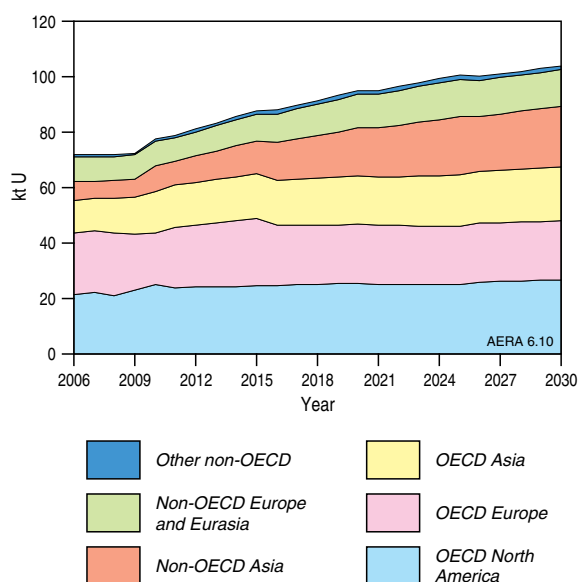
There is considerable uncertainty surrounding world economic growth, energy security, adoption of greenhouse gas emission reduction targets, relative

**Table 6.3** Projected nuclear electricity generation to 2030

Region/Country	Actual	Projections		
	Terawatt hours (TWh)			
	2006	2010	2020	2030
<b>OECD</b>				
<i>North America</i>	891	928	992	1053
United States	787	809	862	907
Canada	93	108	120	135
Mexico	10	11	11	11
<i>Europe</i>	929	922	905	902
<i>Asia</i>	430	441	546	624
Japan	288	299	336	381
The Republic of Korea	141	142	210	243
Australia/New Zealand	0	0	0	0
<b>Total OECD</b>	<b>2250</b>	<b>2291</b>	<b>2443</b>	<b>2579</b>
<b>Non-OECD</b>				
<i>Europe and Eurasia</i>	269	283	424	519
Russian Federation	144	155	251	328
Other	124	128	173	191
<i>Asia</i>	111	151	455	678
China	55	65	274	425
India	16	37	104	149
Other Asia	40	48	77	104
<i>Other</i>	31	37	62	68
<b>Total Non-OECD</b>	<b>411</b>	<b>471</b>	<b>941</b>	<b>1266</b>
<b>Total World</b>	<b>2660</b>	<b>2761</b>	<b>3385</b>	<b>3844</b>

Source: EIA 2009a

costs of generating technologies and changes in policy relating to nuclear power. All present risks to the consumption projections in figure 6.10. In particular, there is potential for nuclear power, and thus demand for uranium, to grow faster than projected if the introduction of policies such as emissions reduction targets reduce demand for coal before alternative low emission energy sources become economic.



**Figure 6.10** Projected world uranium consumption, to 2030

Source: ABARE

## 6.2.2 Australia's uranium resources and market

### Uranium resources

Australia has the world's largest RAR of uranium recoverable at less than US\$80/kg U, with 1163 kt of resources in this category at December 2008 (table 6.4; figure 6.11). Australia accounts for 38 per cent of world RAR recoverable at less than US\$80/kg U. Based on current Australian production and RAR at 2008, the estimated resource life is about 140 years. Australia has an additional 449 kt of uranium in Inferred Resources recoverable at less than US\$80/kg U, which are also the world's largest resources in this category.

**Table 6.4** Australia's uranium resources, December 2008

	unit	recoverable <US\$ 80/kg U	recoverable in range US\$ 80 – 130/kg U
Reasonably Assured Resources (RAR)	kt	1163	13
Inferred Resources	kt	449	48
<b>Total Identified Resources</b>	<b>kt</b>	<b>1612</b>	<b>61</b>

Source: Geoscience Australia 2009

Olympic Dam in South Australia is the world's largest known uranium deposit. In September 2009, BHP Billiton released its annual report stating improvements in metallurgical recovery for uranium and revising ore reserves and mineral resources. Reported ore reserves at Olympic Dam have increased by 22 per cent and total mineral resources have increased by 5 per cent. The deposit has not yet been completely drilled out. Geoscience Australia estimated that as at June 2009 Australia's RAR recoverable at less than US\$80/kg U is 1210 kt U, an increase of 4 percent compared with December 2008.

The location of Australia's uranium deposits and the relative size of resources is shown in Figure 6.11.

The majority of Australia's uranium resources occur in four types of deposits which vary significantly in both tonnage and grade:

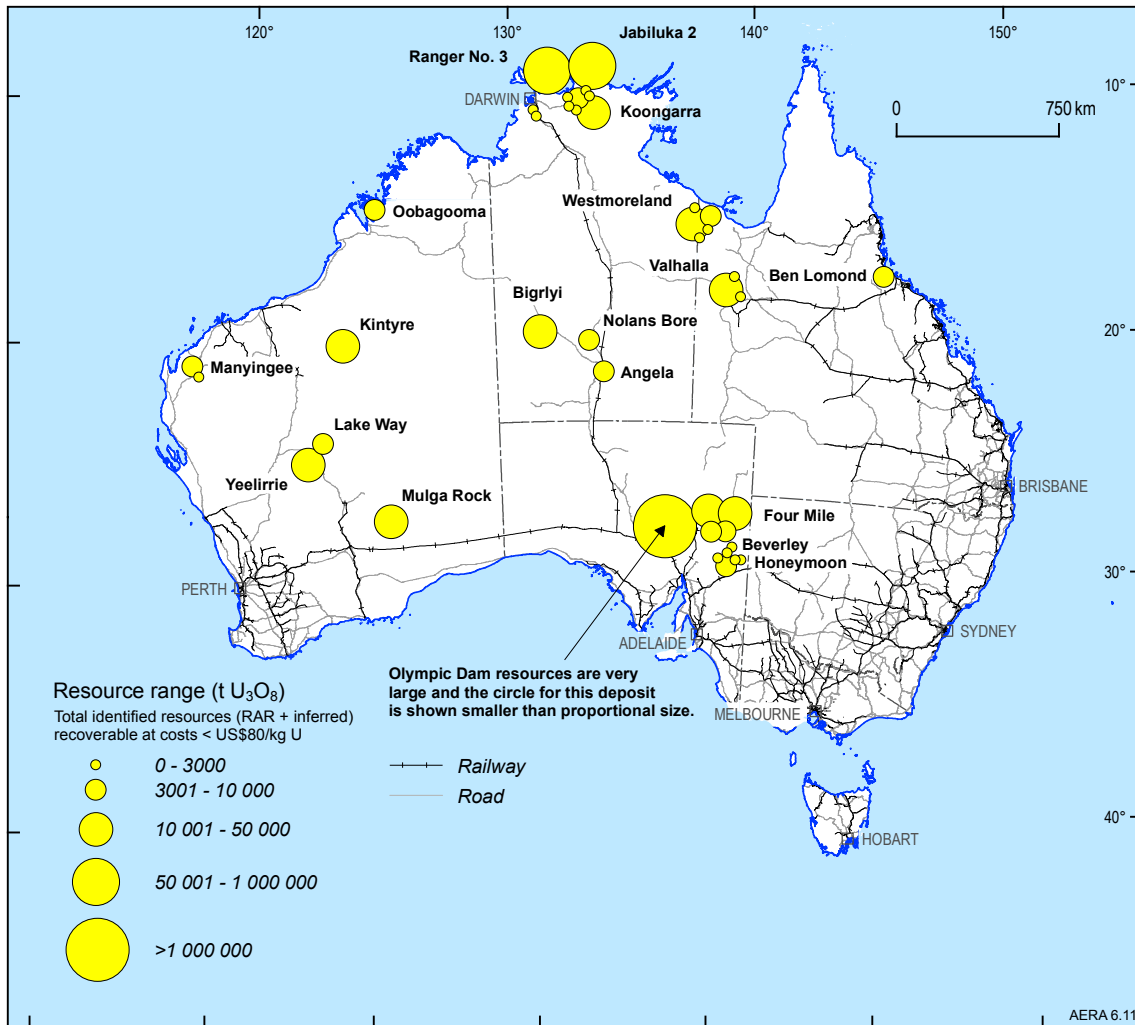
*Hematite breccia complex deposits* contain about 65 per cent of Australia's total uranium resources and all of these resources are at Olympic Dam (South Australia).

*Unconformity-related deposits* account for about 20 per cent of Australia's total resources. These deposits are mainly in the Alligator River region in the Northern Territory (Ranger, Jabiluka, Koongarra), and in one deposit in the Rudall Province, Western Australia (Kintyre). The unconformity-related deposits have the highest average grades overall but show a very wide range in size.

*Sandstone deposits* account for about 7 per cent of Australia's total known Identified Resources, and occur mainly in the Frome Embayment region in South Australia (Beverley, Four Mile, Honeymoon, East Kalkaroo, Goulds Dam) and the Westmoreland area in northwest Queensland (Redtree, Junnagunna, Huarabagoo). Other significant sandstone type deposits include Manyingee, Mulga Rock and Oobagooma in Western Australia, and Angela in Northern Territory.

*Calcrete deposits* have about 5 per cent of Australia's Identified Resources. Most calcrete deposits are low grade. The world class Yeelirrie deposit is the largest deposit of this type. Other calcrete deposits include Lake Way, Lake Maitland and Centipede (Western Australia).

*Other types* of uranium deposits in Australia include metasomatite deposits (Valhalla, Skal and Anderson's



**Figure 6.11** Australia's total identified uranium resources

**Source:** Geoscience Australia

Lode, Queensland). Australia has only small resources within metamorphic (remnant resources at Mary Kathleen, Queensland), volcanic (Ben Lomond, Maureen, Queensland) and intrusive deposits (Crocker Well, Mount Victoria, South Australia).

The major uranium ore minerals are uraninite and pitchblende, though a range of other uranium minerals are found in particular deposits. The total initial size of Australian deposits as uranium oxide grade and ore tonnage is plotted in figure 6.12. Whether a deposit has potential for development depends on several factors including the relative tonnage to grade, for example, the Nabarlek mine (Northern Territory) was high grade, but relative low tonnage. In contrast, the Olympic Dam deposit has a very large tonnage but the uranium grade is relatively low. Although the uranium grade is low, Olympic Dam is a major copper and gold producer which offsets the cost of mining uranium.

Some 9 per cent of Australia's RAR are classified as inaccessible for mining. All uranium deposits in Queensland are classified as inaccessible resources

because of the state government's policy banning uranium mining. In the Northern Territory, the Jabiluka and Koongarra deposits are currently classified as inaccessible resources, as approval from Traditional Owners is required before these deposits can be developed.

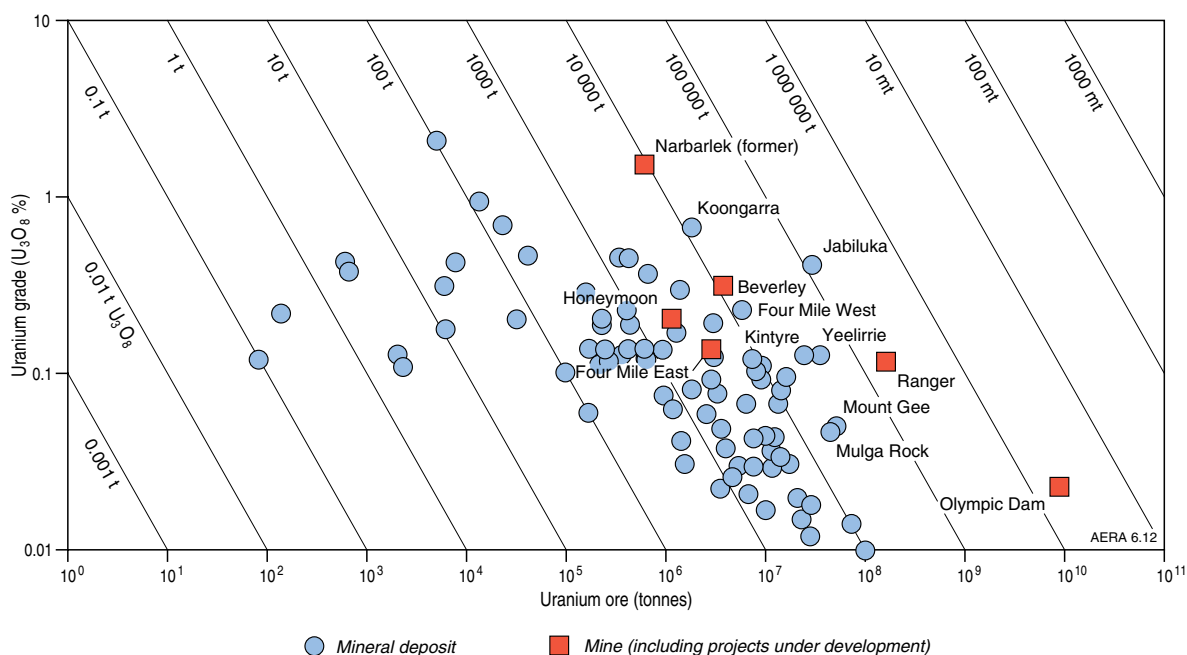
There are several major undeveloped deposits that may be developed if proven economically feasible and all necessary approvals are granted. Table 6.5 summarises the total ore reserves and mineral resources of the main undeveloped deposits as reported by resources companies.

### Uranium market

#### Production

Currently, Australia has three operating mines, Energy Resources of Australia's Ranger open pit mine in the Northern Territory, BHP Billiton's Olympic Dam underground mine and Heathgate Resources' Beverley ISR mine in South Australia. In addition, there are two ISR mines, Alliance Resources' and Quasar Resources' Four Mile and Uranium One's Honeymoon, expected to be producing in 2010.





**Figure 6.12** Australian mines and deposits (total resources, including past production and current remaining) by grade and tonnage

Source: Geoscience Australia

**Table 6.5** Major undeveloped uranium deposits in Australia

Deposits	Ore reserves	Mineral resources
	contained $U_3O_8$ (kt)	
<b>Northern Territory</b>		
Jabiluka 2	67.70	73.94
Koongarra	14.50	
Bigrlyi	-	10.59
Angela	-	9.89
<b>South Australia</b>		
Mt Gee	-	31.30
4 Mile West	-	15.00
Crocker Well & Mt Victoria	-	6.74
<b>Queensland</b>		
Valhalla	-	25.90
Westmoreland (Redtree, Junnagunna, Huarabagoo, Sue & Outcamp)	-	23.62
<b>Western Australia</b>		
Yeelirrie	-	56.53
Kintyre	-	31.90
Mulga Rock	-	24.52
Manyingee	-	10.90
Oobagooma	-	9.95
Centipede-Millipede-Abercombie	-	5.04
Lake Maitland	-	8.32
<b>Total</b>	<b>82.20</b>	<b>344.14</b>

Note: Ore reserves and mineral resources are company estimates

Source: Geoscience Australia

In 2008, Australia was the world's third largest uranium producer, accounting for 19 per cent of world production. Australia produced around 4872 PJ (8.7 kt U) in 2008–09 from three operating mines. Ranger accounted for 54 per cent of Australian mine production while Olympic Dam produced 40 per cent and the Beverley operation accounted for around 6 per cent of Australia's uranium production.

Between 1954 and 1971, Australia produced a total of about 7.7 kt U from five mines: Radium Hill (South Australia), Mary Kathleen (Queensland), Rum Jungle (Northern Territory) and two sites in the South Alligator Valley (Northern Territory). The mines were developed to satisfy contracts with the United Kingdom Atomic Energy Authority and the Combined Development Agency, a joint United Kingdom and United States uranium purchasing agency. These mines were closed after fulfilling their contracts.

Increasing prices in the early 1970s as a result of improved demand for uranium for energy purposes led to the reopening of Mary Kathleen in 1975 and the opening of two new mines in the Northern Territory, Queensland Mines' Nabarlek mine and Energy Resources of Australia's Ranger mine, in 1979 and 1980 respectively (figure 6.13). Australian mine production increased strongly until the mid 1980s when both Nabarlek and Mary Kathleen mines were closed. The Olympic Dam operation, a major new mine in South Australia, commenced production in 1988, and offset some of the mine closures. However, reduced demand for uranium as a result of increased availability of secondary supplies resulted in Australia's uranium production declining until the mid-1990s.

Australian uranium production has expanded strongly over the past 10 years as producers have responded to growing export demand. South Australia has contributed to most of this growth, reflecting the expansion at Olympic Dam in 1999 and the development of the Beverley mine in 2001. Capital expenditure on the Beverley mine was A\$30 million; it has a capacity of 1 kt  $U_3O_8$  per year. The 1999 Olympic Dam expansion had a capital cost of nearly A\$2 billion, which increased the capacity of the mine

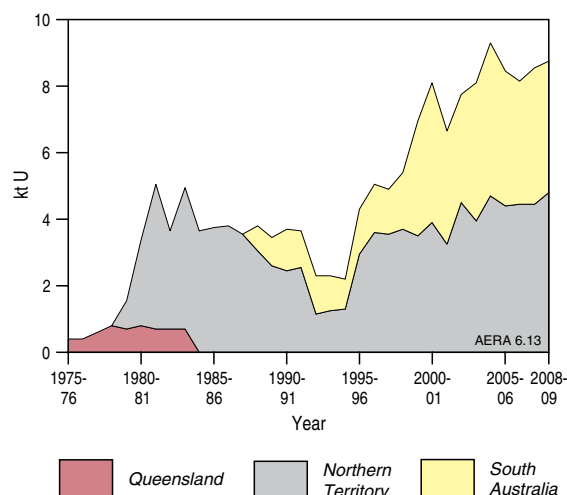


Figure 6.13 Australian uranium production, by state

Source: ABARE 2009c

to 4.3 kt  $U_3O_8$  per year (table 6.6), together with increased copper and gold production. Production at the Ranger mine in the Northern Territory has also contributed to higher production over this period. The addition of a radiometric sorter and laterite processing plant in 2008 and 2009 respectively will support higher production at the Ranger operation in the future.

#### Consumption

Australia does not consume any of its locally produced uranium. A small amount of low enriched uranium is imported for use at Australia's Nuclear Science and Technology Organisation's (ANSTO) Lucas Heights OPAL research reactor. The research reactor provides medical isotopes for nuclear medicine and treatment, scientific research and irradiation of industrial materials. In 2008, Australia's consumption of uranium totalled less than 100 kg of low enriched uranium (ASNO 2009).

#### Trade

Australia exports all its uranium (figure 6.14) to countries within its network of bilateral safeguards agreements, which ensure that it is used only for peaceful purposes and does not enhance or contribute to any military applications.

Table 6.6 Recent developments at current Australian mines

Project	Company	State	Start up	Production capacity kt $U_3O_8$ / year	Capital Expenditure A\$m (nominal)
Olympic Dam 1999 expansion	BHP Billiton	SA	1999	4.3	1940*
Beverley ISR mine	Heathgate Resources	SA	2001	1.0	30
Ranger radiometric sorting plant	Energy Resources of Australia	NT	2008	1.1	19
Ranger laterite plant	Energy Resources of Australia	NT	2009	0.4	44

\*Capital expenditure covers total expansion of copper-gold-uranium-silver mining

Source: ABARE

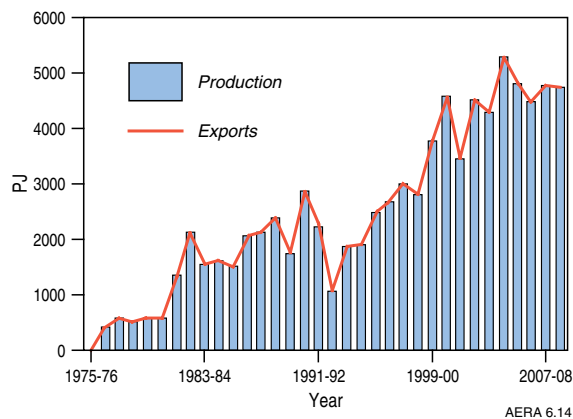
**Table 6.7** Australia's uranium exports to end-users, 2008

	U <sub>3</sub> O <sub>8</sub> kt	Share of total %
United States	4.381	45.3
Japan	2.281	23.6
France	1.015	10.5
Republic of Korea	0.387	4.0
Sweden	0.340	3.5
China	0.313	3.2
Canada	0.256	2.7
Taiwan	0.243	2.5
United Kingdom	0.171	1.8
Spain	0.107	1.1
Finland	0.092	1.0
Germany	0.076	0.8
<b>Total</b>	<b>9.662</b>	<b>100.0</b>

Source: ASNO 2009

Australian mining companies supply uranium under long-term contracts to electricity utilities in United States, Japan, China, the Republic of Korea, Taiwan and Canada as well as members of the European Union including the United Kingdom, France, Germany, Spain, Sweden, Belgium and Finland. In 2008, Australia's largest uranium export destination was the United States (45 per cent of total exports), followed by Japan (24 per cent) and France (10 per cent) (table 6.7). Australia's uranium exports contain sufficient energy to generate more than twice Australia's current annual electricity demand (Commonwealth of Australia 2006a).

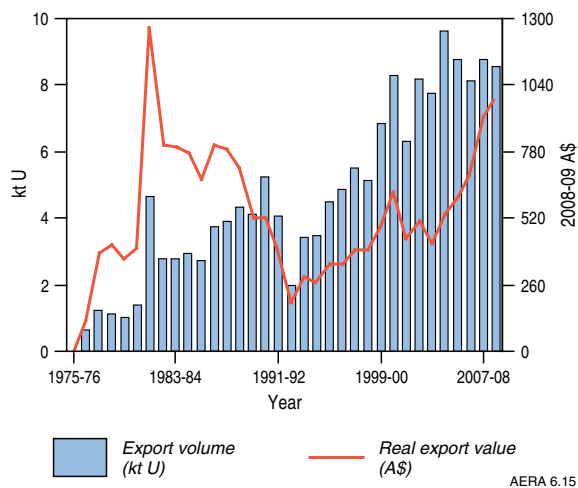
In 2008–09, Australia exported 4805 PJ (8.58 kt U) valued at \$1033 million (ASNO 2009). This was 13 per cent higher than in 2007–08 (\$914 million in 2008–09 dollars) despite a modest decline in export volumes. The value of Australia's uranium export earnings has increased significantly over the past 15 years, reflecting growth in both export volumes and prices (figure 6.15; ABARE 2009a, b).



**Figure 6.14** Australia's uranium supply-demand balance

Source: ABARE 2009b

Uranium is commonly traded through long term contracts which are negotiated in both price (spot and long term) and quantity terms. In Australia, uranium producers sell most of their production through these long term contracts. Only a small amount of Australian uranium is sold on the world spot market. Historically, secure contract prices have been negotiated for long time periods. More recently an industry trend of indexing contract prices to spot prices has emerged, although most of Australia's current long term contracts do not have these provisions.

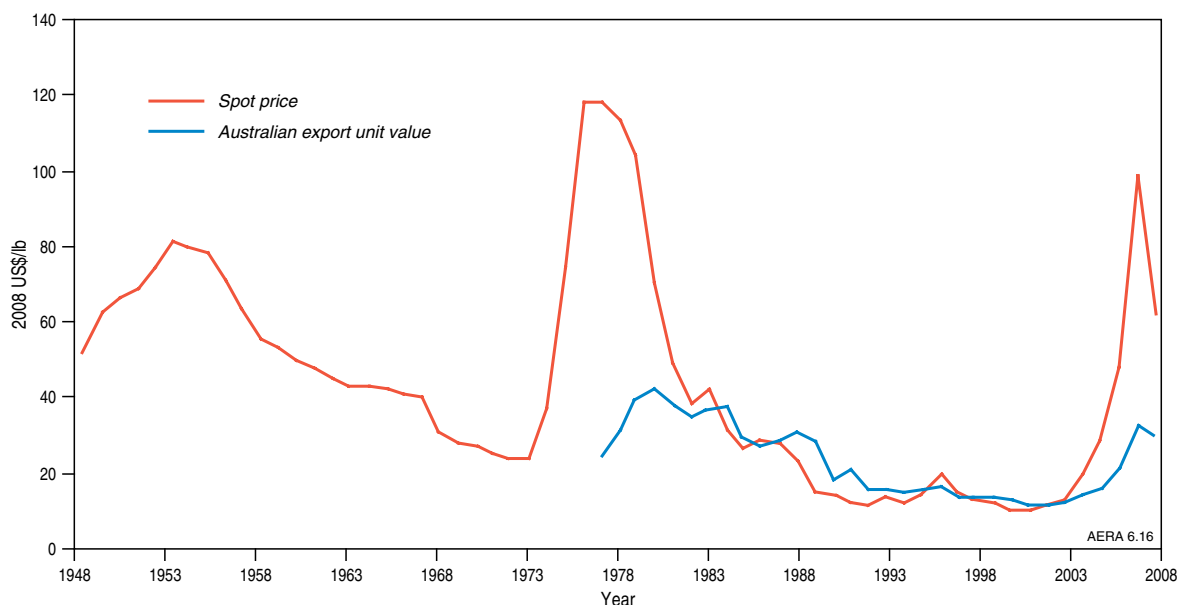


**Figure 6.15** Australia's exports of uranium

Source: ABARE 2009c

As most trade is conducted through long term contracts, the uranium spot market is illiquid (small number of buyers and sellers) which can lead to volatility in prices. Reflecting this, the average export price for Australian uranium producers has been considerably less volatile than the spot price in recent years (figure 6.16). In late 2008, the spot price was also influenced by the development of a futures market resulting in speculative purchases of uranium by investment companies.

In the future, it is likely that an increasing number of Australian producers will sell their production on the spot market, reflecting the small size of many of the planned uranium operations. If this occurs, Australian uranium producers may be exposed to increased volatility in export earnings. It is also possible that future long term contracts may be linked to spot prices, further contributing to income volatility.



**Figure 6.16** Uranium spot prices and average Australian export unit prices

Source: ABARE 2009c; Ux Consulting 2009

### 6.2.3 Outlook to 2030 for Australia's resources and market

The outlook to 2030 is based on Australia continuing to be a major producer and exporter of uranium as nuclear fuel to world markets. There are no plans for Australia to have a commercial nuclear power industry or enrichment facilities; all of Australia's uranium production will continue to be exported. There is renewed interest worldwide in nuclear power. Demand for reliable supplies of uranium will therefore grow to meet the continued expansion of electricity generation from nuclear power.

Australia has the largest uranium resources in the world. There are several significant known but undeveloped deposits, and there is a strong likelihood of new resource discoveries from the exploration of prospective areas currently under way.

In the medium to long term, Australia's production of uranium is expected to increase significantly, reflecting Australia's large low cost uranium resources, proposed new mines and increasing export demand.

Australia's uranium production is projected to more than double from 4872 PJ (8.7 kt U) in 2008–09 to 11 760 PJ (21 kt U) by 2029–30.

#### Key factors influencing the outlook

A report to government on uranium mining, processing and nuclear energy in Australia (Commonwealth of Australia 2006a) noted that Australia was 'well positioned to increase production and export of uranium to meet market demand' and that 'downstream steps of uranium conversion,

enrichment and fuel fabrication could add a further A\$1.8 billion of value annually if Australian uranium was processed domestically'. The report noted however that there were commercial, technology and regulatory impediments to downstream processing.

The report also considered issues associated with the potential development of nuclear power in Australia and concluded that even if the current legislative impediments were removed it would be at least 10 years and most likely 15 years before nuclear electricity could be delivered. By then, Generation IV reactors, which use uranium more efficiently, result in less waste and are less conducive to nuclear weapon proliferation, are likely to be the industry standard.

World demand for uranium as a nuclear fuel is expected to continue to grow with the expansion of nuclear power worldwide. The factors that will influence demand include:

- Commitment to greenhouse gas emissions reduction targets,
- Increased demand for low emission electricity generation provided by nuclear power,
- Increased demand for new reactors that provide greater security and safety, generate less radioactive waste and are more resistant to nuclear weapon proliferation, and
- Conversely, increased efficiency of these reactors, which may constrain the expected growth in uranium demand through more efficient use of uranium and the ability to use reprocessed nuclear fuel.

As a reliable and secure supplier of uranium to the world market, Australia is well placed to meet a significant proportion of any increased demand for uranium for use as an energy resource. Any expansion of Australian uranium production and exports to meet this demand will be influenced by several factors, including;

- significant potential for new uranium discoveries,
- undeveloped deposits that are capable of being developed at low cost,
- limited port and shipping company options for export uranium, and
- uranium mining prohibitions in Queensland, New South Wales and Victoria.

#### *Cost competitiveness – increased global competition*

Australia is well placed to make a greater contribution to meeting the projected increase in global demand for uranium because of its large low cost uranium resources and the potential to develop projects at the lower portion of the cost curve. Australia is a reliable supplier of uranium, which is of strategic importance to utilities.

The capital costs vary with mining method. In general, ISR operations are lowest cost, with underground and open pit mines being more expensive per tonne of uranium produced. For an operation of comparable size, open cut mining may be less capital intensive than underground mining. However, large scale bulk underground operations that achieve economies of scale can be comparable to open cut operations.

Conventional open cut and underground mining is the most common extraction technique in the uranium industry, accounting for around 72 per cent of world uranium production, with ISR accounting for the remaining 28 per cent (WNA 2009b).

The differences in cost are dependent in part on ore grade and type, infrastructure requirements, and economies of scale. Operating costs are dependent on the metallurgical process required to produce  $U_3O_8$ . Uranium deposits comprising uraninite typically have a relatively simple acid leach metallurgy process with

estimated production costs of US\$15–30 per pound  $U_3O_8$ . Calcrete deposits commonly require alkali leach and can have higher production costs of US\$35–50 per pound  $U_3O_8$  (TORO Energy Limited 2008).

Cost pressures have influenced the development of uranium mines. In 2007 and 2008, input costs increased dramatically, reflecting rising costs for fuel, labour, power and acid for processing. Recently there has been some indication that cost pressures have eased in the mining sector following the global economic downturn, with the price of major inputs declining. However, this fall may be only short-lived, with cost pressures likely to return once demand for energy and mineral commodities returns.

A further factor which may increase the cost of developing a mine is the site itself – the more remote and difficult the location, the higher the infrastructure costs (Schodde and Trench 2009).

In general, the next generation of uranium development projects worldwide will be lower average grade and of smaller deposit size than the currently operating mines. Many existing mining operations are planning expansions, which may result in new development projects being deferred until mines close or demand grows significantly. Expansions of existing mines are generally less capital intensive than greenfield projects.

Over the past decade, growth in new uranium mines has been slow and concentrated in a small number of countries, mainly Kazakhstan, Namibia and Niger. Of the seven major mines developed since 2006, five were ISR developments (table 6.8).

ISR mines tend to be smaller with a limited surface disturbance, hence capital costs are lower than conventional mines reflecting reduced infrastructure requirements. However, ISR is only suitable for deposits in sandstones which are water saturated and in which the mining solutions can be contained. It is estimated sandstone hosted uranium deposits account for approximately 20 per cent of world uranium resources and 7 per cent of Australia's total uranium resources (OECD/NEA and IAEA 2008).

**Table 6.8** Uranium projects completed recently worldwide

Project	Location	Mining method	Commenced production	Capacity kt $U_3O_8$ /year	Capital cost US\$m (nominal)	Unit cost US\$/t $U_3O_8$ (nominal)
Kayelekera	Malawi	Open cut	2009	1.65	167	101 212
Irkol	Kazakhstan	ISR	2009	0.88	-	-
Kharasan (1 & 2)	Kazakhstan	ISR	2009	5.9	430	72 931
West Mynkuduk	Kazakhstan	ISR	2008	1.18	-	-
Moinkum (Muyunkum)	Kazakhstan	ISR	2006	0.59	90	152 542
Langer Heinrich	Namibia	Open cut	2006	1.18	120	101 781
Zarechnoye	Kazakhstan	ISR	2006	1.18	60	50 891

**Note:** ISR = in situ recovery. Capacity is the nominal target production capacity

**Source:** WNA Country briefs



**Table 6.9** Costs of Australian ISR uranium projects

Project	State	Production commencement	Capacity kt U <sub>3</sub> O <sub>8</sub> /year (nominal)	Capital cost A\$m	Unit cost A\$/t (nominal)
Beverley	SA	2000	1.00	58	58 000
Four Mile*	SA	2010	1.36	112	82 400
Honeymoon	SA	2010	0.40	118	295 000

\* Four Mile operation is using the processing facilities at Beverley

Source: ABARE

In Australia, there is one operating ISR mine (Beverley) and two ISR projects approved for development (table 6.9). Capital costs per unit of production vary considerably between these three projects reflecting the time of construction. The Four Mile ISR project has an expected capital cost per tonne of capacity of A\$82 400. The low unit cost of the Four Mile operation is because the mined material will be processed at the nearby Beverley operation. In contrast, the Honeymoon operation has an expected capital cost of A\$295 000 per tonne of capacity, reflecting the additional cost of constructing a processing facility.

The time and cost of the approval process is an additional factor in development costs. In Australia, new and expanding uranium mines require environmental and development approvals prior to any development occurring. The approval process period for the development of a uranium mine can be lengthy and costly if it is not well managed. Companies are required to provide a detailed environmental assessment for a uranium development proposal, which is assessed by both Australian and state/territory governments before approval to develop is granted. As demonstration of the detail involved in this process, BHP Billiton recently released an Environmental Impact Statement (EIS) for the proposed Olympic Dam expansion, which is a three stage project from a current production of 4.3 kt to 19 kt per year of U<sub>3</sub>O<sub>8</sub>. Reflecting the complexity of the expansion and changes to project configuration, the EIS took the company nearly five years to complete. The approval process is expected to take at least another year. In contrast, the small Four Mile ISR project (South Australia) producing 1.36 kt U<sub>3</sub>O<sub>8</sub> per year will take less than five years from discovery to production, which reflects, in part, the type of mine and the fact that the operation will use pre-existing processing facilities at the adjacent Beverley mine.

#### *Secondary supply – continues to fill demand*

The uranium requirement for nuclear reactors is currently met from both mined uranium and secondary supply. Secondary supply from blending down highly enriched uranium (HEU) is expected to decline from 2013 (figure 6.8), but uranium from reprocessed nuclear fuel may play an important role in supplying uranium to meet demand.

According to Euratom, reprocessing is an attractive option, both environmentally and economically (Euratom Supply Agency 2009). Euratom considers that the process not only provides secondary supply (referred to as reprocessed uranium, or RepU) but also reduces the volume, and level of radioactivity of high-level waste material. It also reduces the possibility of plutonium being diverted from civilian use. Technically, at least, recovered uranium and plutonium can be recycled as fresh fuel, with a potential saving of up to 30 per cent of the natural uranium that would otherwise be used.

Almost 90 kt (of the 290 kt discharged) of used fuel from commercial power reactors has been reprocessed. There are reprocessing plants in France, Japan, the Russian Federation and the United Kingdom. Annual reprocessing capacity is now some 4 kt per year for normal oxide fuels. Between 2009 and 2030 around 400 kt of used fuel is expected to be generated worldwide, which is a potential secondary source (WNA 2009e).

#### *Technology developments – new generation of nuclear reactors*

At October 2009, there were 436 nuclear power reactors in operation in 30 countries requiring around 65 kt U per year. There are 53 reactors under construction in several countries including China, India, the Republic of Korea and the Russian Federation. Over 135 reactors are planned with approvals, funding or firm commitments in place; they are expected to be in advanced stages of construction, if not operating, within eight years. There are 295 further reactors proposed in over 30 countries. These proposals are expected to result in reactors in operation within 15 years (WNA 2009f). Altogether, there are about 483 reactors under construction, planned or proposed.

The nuclear power industry has been developing and improving reactor technology for more than five decades (box 6.1). Generation I prototype reactors were developed in the 1950s. Generation II reactors were developed as commercial reactors in the late 1960s, and are currently operating for electricity generation in most countries with nuclear power. Over the last 20 years many of these reactors have received extensions of operating licences from 40 to 60 years. In addition there have been increased

operating efficiencies and improved maintenance which have resulted in increased capacity and electricity output. In the United States, the average capacity factor increased from 56 per cent in 1980 to over 90 per cent in 2002 (EIA 2009b). Worldwide, the average unit capacity factor from 2006 to 2008 was 82.4 per cent (IAEA 2009). Consequently, electricity generation has increased markedly over the two decades despite little increase in installed capacity.

Generation III (and III+) reactors incorporate improved fuel technology, thermal efficiency and passive safety systems. The first Generation III reactors have been operating in Japan since 1996. Generation III reactors are currently being built (and planned to be built) in many countries.

Generation IV reactors are still being designed and none have been built to date. The Generation IV International Forum, representing 13 countries, has selected six reactor technologies which will form the future of the nuclear power industry (box 6.1). Generation IV reactors will operate at higher temperatures (in the range 500°C to 1000°C) than current commercial light water reactors (less than 300°C). The technology and design of these new reactors are aimed at:

- using passive safety features which require no active controls or operational intervention to avoid accidents in the event of malfunction;
- being more resistant to diversion of materials for weapons proliferation, and secure from terrorist attack;
- using the uranium fuel efficiently by using U<sup>238</sup> and plutonium, as well as all the U<sup>235</sup>; and using spent fuel from current commercial reactors;
- utilising uranium up to 60 times more efficiently; and

- greatly reducing amounts of high level radioactive waste compared with current reactors.

Generation IV reactors will have a lower demand for uranium due to the more efficient fuel burn and will minimise high level waste sent to repositories. These nuclear reactors will alter the nature and scale of high level radioactive waste (HLW) disposal by substantially reducing the volume of these wastes (Commonwealth of Australia 2006a). Less HLW and less heat generated from radioactive waste (compared with current spent fuel) will enable more effective use of geological HLW repositories. Current planning for HLW repositories in many countries is based on assessment of the amount of waste from current commercial reactors. This will be modified when Generation IV reactors become commercially viable and advanced fuel processing is successful. It is too early to determine which of the Generation IV technologies will be commercially adopted.

#### *Best practice sustainable uranium projects*

The Australian Government supports the development of uranium deposits in line with world's best practice environmental and safety standards. New uranium mines are subject to approval by the Australian and state/territory governments. Development of uranium mines is permitted in South Australia, Northern Territory, Western Australia and Tasmania. New South Wales and Victoria have legislated against uranium exploration and mining. Queensland government policy bans the development of uranium mines.

Uranium mining proposals involve integrated consideration under both the Commonwealth Environment Protection and Biodiversity Conservation Act 1999 (EPBC Act) and state/territory legislation. Regulation of all mines in Australia focuses on the outcomes to be achieved and is largely the responsibility of state/territory authorities. The principles and approaches for all mining

### **BOX 6.1** GENERATION I TO IV REACTOR TECHNOLOGIES

Nuclear reactors have been in commercial operation since the 1950s with reactors evolving from early designs (Generation I) to five Generation II reactor designs which today account for most nuclear reactors operating in the world. Reactors currently under construction are Generation II and III (III+) reactors.

Generation III reactors have standardised more robust design with inherent safety features and higher 'burn-up' to maximise use of fuel and reduce the amount of waste created. The standardised design is reducing capital cost and construction time.

Generation IV reactors are currently in research and development and are not expected to be available for commercial construction before 2030. The goals of the Generation IV reactors are improved nuclear safety, proliferation resistance, increased fuel

utilisation, minimised waste and decreased cost to build and operate. The six Generation IV systems selected for R&D are:

**Gas-Cooled Fast Reactor (GFR)** – a fast-neutron-spectrum, helium cooled reactor and closed fuel cycle;

**Very-High-Temperature Reactor (VHTR)** – a graphite-moderated, helium cooled reactor with a once-through uranium fuel cycle;

**Supercritical-Water-Cooled Reactor (SCWR)** – a high-temperature, high pressure water cooled reactor;

**Sodium-Cooled Fast Reactor (SFR)** – features a fast-spectrum, sodium-cooled reactor and a closed fuel cycle for efficient conversion of fertile uranium and management of actinides;

**Lead-Cooled Fast Reactor (LFR)** – features a fast spectrum lead of lead/bismuth eutectic liquid-metal-cooled reactor and a closed fuel cycle for efficient conversion of fertile uranium and management of actinides; and

**Molten Salt Reactor (MSR)** – uses a circulating molten salt fuel mixture with an epithermal-spectrum reactor and a full actinide recycle fuel cycle.

#### *Nuclear reactors in operation*

Table 6.10 provides an overview of the types of nuclear reactors currently in operation and under construction, followed by a summary of the features of the five common nuclear reactors types.

Pressurised Water Reactors (PWR) and Boiling Water Reactors (BWR) are collectively referred to as Light Water Reactors (LWR). These reactors are cooled and moderated using ordinary water (fresh or seawater). The designs are simpler and cheaper to build than other types of nuclear reactor, and they are likely to remain the dominant technology for the present.

**Table 6.10** Nuclear reactors in operation or under construction, by reactor type, in 2009

	no.	GW(e)
<b>Operational</b>		
Pressurised Water Reactors	264	243.1
Boiling Water Reactors	92	83.7
Pressurised Heavy Water Reactors	44	22.4
Gas Cooled Reactors	18	8.9
Light Water Graphite-moderated Reactors	16	11.4
Fast Breeder Reactors	2	0.7
<b>Total</b>	<b>436</b>	<b>370.2</b>
<b>Under Construction</b>		
Pressurised Water Reactors	43	39.9
Pressurised Heavy Water Reactors	4	1.3
Boiling Water Reactors	3	3.9
Fast Breeder Reactors	2	1.2
Light Water Graphite-moderated Reactors	1	0.9
<b>Total</b>	<b>53</b>	<b>47.2</b>

Source: IAEA

#### *Pressurised Water Reactors (PWR)*

The PWR consists of a primary and a secondary circuit of water; both circuits are closed systems. The primary circuit contains pressurised water (to prevent it from boiling) which is heated to over 300°C as it moves through the reactor core. Once heated, water in the primary circuit circulates through heat exchangers which boil water in a secondary circuit. Steam produced in the secondary circuit drives a turbine to produce electricity – the water is then condensed and returned to the heat exchangers to be transformed back into steam. PWR are the most common nuclear reactors. There are 264 generating

units currently in operation with a total capacity of 243.1 gigawatts electric (GWe).

#### *Boiling Water Reactors (BWR)*

BWR utilise a similar method to the PWR except that a single circuit is used to heat water and produce steam to generate electricity. Water in the circuit is maintained at a low pressure allowing it to boil at around 285°C. The water is condensed and returned to the core to be transformed back to steam. BWR have a less complicated design and are often cheaper to build; however this cost advantage is often offset by the increased costs incurred as a result of residual radiation on turbines. They are the second most common reactor design, accounting for around 21 per cent of the world's 436 nuclear reactors.

#### *Pressurised Heavy Water Reactors (PHWR)/CANDU reactors*

The PHWR or CANDU reactors are designed to use low enriched uranium directly as a fuel. The PHWR use a similar design to the PWR with a reaction in the core heating a coolant in a primary circuit which is then used to boil water in a secondary circuit. The PHWR differ from the PWR in that heavy water (water containing deuterium) is used as a coolant. The fuel rods are cooled by a flow of heavy water under high pressure in the primary cooling circuit. The pressure tube design means that the reactor can be refuelled progressively without shutting down. Forty four PHWR are currently in operation (around 40 per cent in Canada) with a combined capacity of 22.4 GWe.

#### *Gas Cooled Reactors (GCR) and Advanced Gas-cooled Reactors (AGR)*

GCR are considered safer than traditional water cooled reactors as the cooling properties of gas do not change with temperatures. The GCR use natural uranium fuel and the AGR use an enriched uranium dioxide fuel. Carbon dioxide is used as coolant which circulates through the core, reaching 650°C before passing through a steam generator creating steam in a secondary circuit. In the 1980s, following the success of LWR, the United Kingdom made the decision to adopt LWR technology. As a result no gas cooled reactors have been built since.

#### *Light water graphite-moderated reactors (LWGR)*

The LWGR are Russian-designed, based heavily on the BWR. The design operates with enriched uranium dioxide fuel at high pressure and uses water as a coolant which is allowed to boil at around 300°C. This design can have a positive feedback problem that results in excessive heat being released from the core. For this reason there are no plans to build new LWGRs beyond the one currently under construction. Currently, 16 of these reactors are in operation in the Russia Federation and Lithuania.

Source: WNA 2009g, h

have helped achieve increased trust by stakeholders through a clear up-front agreement on the environmental outcomes to be achieved and a demonstration by the mining operator that environmental, social and economic elements of the project are being managed appropriately.

The Australian Government and the jurisdictions that currently permit uranium mining (South Australia, Northern Territory and Western Australia) are developing a national ISR uranium mining best practice guide, to ensure that ISR proposals represent best practice environmental and safety standards. The guide outlines and discusses the general principles and approaches that should apply to all mining in Australia, before considering ISR uranium mining more specifically.

With regard to radiation protection in mining, state and territory governments adopt the regulatory approach outlined in the Code of Practice and Safety Guide on Radiation Protection and Radioactive Waste Management in Mining and Mineral Processing (2005) produced by the Australian Radiation Protection and Nuclear Safety Agency (ARPANSA).

Sustainable growth of the uranium industry requires community engagement to communicate the environmental and safety practices built into the project and to demonstrate that there are effective regulatory controls. Engagement, consent and land use agreements with Indigenous communities are essential in areas where Indigenous groups hold rights over or interests in the land.

The Australia Government's Uranium Industry Framework (UIF) Steering Group was established in 2005 to identify opportunities for, and impediments to, the further development of the Australian uranium mining industry over the short, medium and longer term while ensuring world's best environmental, health and safety standards. An Implementation Group was established to progress the recommendations from the UIF Steering Group report (Commonwealth of Australia 2006b). The priorities to date include: development of a national radiation dose register for uranium workers; facilitating discussion of uranium exploration and mining issues with Indigenous communities; addressing concerns about the transport of uranium and instances of international shipping denials and delays; establishing nationally accredited radiation safety training programs; and reviewing regulation applying to the uranium industry.

#### *Transportation issues*

All Australian exports of radioactive material, such as  $U_3O_8$ , require an export permit. These are assessed by the Australian Government to ensure that Australia's uranium is exported to countries for peaceful purposes under Australia's network of bilateral safeguards agreements. Each shipment of uranium leaving Australia must be reported to the Australian

Government and is tracked and accounted for in the international nuclear fuel cycle.

Any significant expansion of uranium exports will require improved access to transport options. Currently, uranium is exported from two ports, Darwin in the Northern Territory and Adelaide in South Australia.

In South Australia, uranium exports through the Adelaide port will continue to grow as planned projects such as Honeymoon and Four Mile commence shipping uranium through this port. In addition, the Olympic Dam Expansion plans to export uranium through both Adelaide and Darwin container ports with the uranium transported by train to both of these destinations.

Western Australian uranium production is likely to commence in the medium term with projects such as Yeelirrie and Kintyre potentially entering production. Current plans for uranium transport is by road to rail heads, loaded onto trains and transported to the Darwin or Adelaide ports for export.

Uranium oxide is classified as a Class 7 Dangerous Good which has specific handling and transport requirements. It is transported by rail, road and sea in 200 litre drums packed in secure shipping containers.

There are increased international transport constraints affecting Class 7 goods, such as the consolidation of the international shipping industry and associated reduction in scheduled routes, and reduction in ports where vessels carrying uranium can call or transit, even where this cargo remains on board. The consolidation of shipping firms and denial of routes result in increased delays and costs to the uranium industry. International transport issues, such as denial of shipping, are being progressed through the IAEA's International Steering Committee on Denial of Shipping.

#### **Outlook for uranium resources**

Uranium deposits are known in all states (except Victoria and Tasmania, which only have uranium occurrences) and Northern Territory. Favourable geological settings and limited exploration since 1980 mean that there is significant potential for discovering new deposits. New discoveries are likely to significantly increase Australia's resource base and encourage further exploration in surrounding areas.

Uranium exploration expenditure in Australia has increased since 2003 mainly because of the significant increases in spot market uranium prices, which reached a peak in July 2007 (US\$136/lb  $U_3O_8$ ) and subsequently declined during 2008 (figure 6.17).

In 2008, uranium exploration expenditure reached a record of A\$220.5 million (ABS 2009a). The majority of expenditure was in South Australia (42 per cent), followed by the Northern Territory (26 per cent), Queensland (19 per cent) and Western Australia.



A large number of new companies have been floated in recent years specifically to explore for uranium.

World uranium exploration budgets in 2009 totalled US\$664 million, down from US\$1151 million in 2008. Australia received 26 per cent (US\$175 million) making it the second largest after Canada which received 29 per cent (Metals Economics Group 2009). According to the Metal Economics Group there were 319 companies engaged in uranium exploration worldwide of whom 124 had active exploration in Australia.

Historically uranium exploration in Australia has been highly successful (figure 6.18). Of the 85 currently known uranium deposits in Australia, approximately 50 were discovered from 1969 to 1975 with another four discovered between 1975 and 2003. Annual expenditure on uranium exploration in Australia fell progressively for 20 years from the peak in 1980 until 2003 due to low uranium prices. The most recent significant discovery was the Four Mile deposit in South Australia in 2005, which is the first new uranium mine proposal to be approved by the Australian Government since 2001.

More recently, discoveries of new uranium deposits have not significantly increased Australia's resources. Growth in Australia's uranium resources in recent years has been largely due to ongoing delineation of resources at known deposits. The Olympic Dam deposit in South Australia has been the major contributor to increases in Australia's uranium resources since 1983.

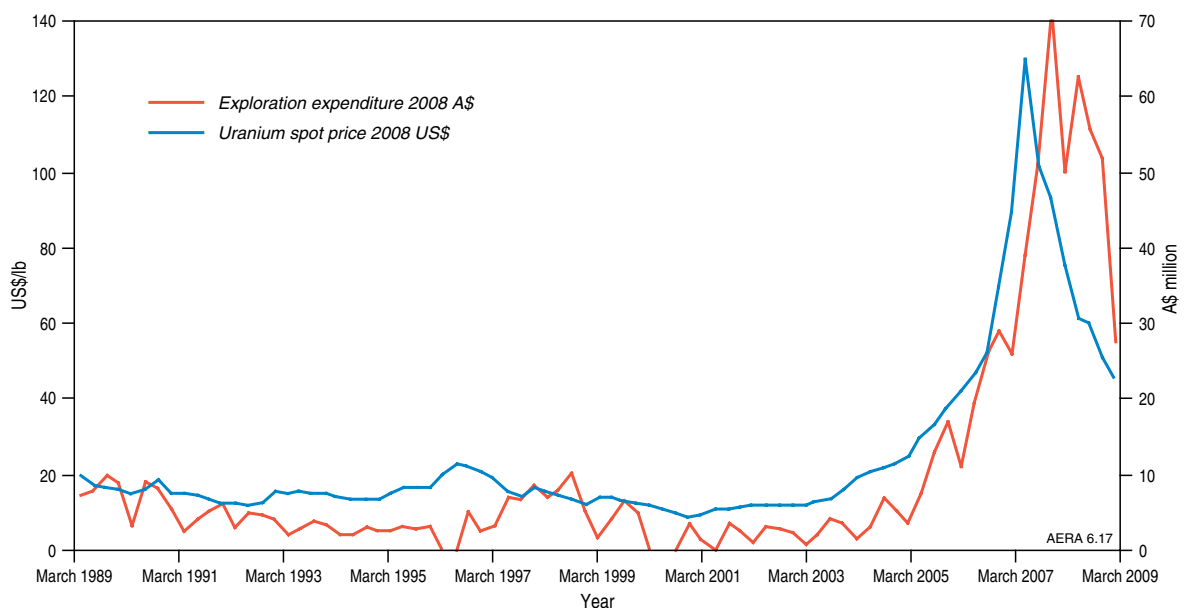
The recent strong exploration activity saw the reporting of a number of intersections of economic interest,

including in the Pine Creek area, Northern Territory and Frome Embayment, South Australia. Whether intersections of uranium result in a new deposit will depend on further exploration. The discovery of a deposit may not be acknowledged until some years later, after subsequent exploration work. For example the discovery year for the Olympic Dam deposit was 1975, but it was a few years later before the full significance of the discovery was appreciated; moreover, the published resources are still growing.

Discovery of new deposits takes time and requires considerable exploration expenditure. Exploration is an uncertain activity with only a small percentage of exploration expenditure leading directly to the discovery of an economic resource. However, exploration is important to developing new deposits and sustaining existing operations by replacing resources as deposits are mined. The price of uranium and future export demand are typically the most important factors affecting the level of expenditure in exploration as these factors influence the return on a deposit and the capital available to operations.

Not all discoveries result in mines. Recent studies found that less than half of the uranium discoveries made in the world since the 1970s have been developed into mines (R Schodde, personal communication 2009). A major factor for the high level of failed projects is the low grade and/or small size of these discoveries. Only the best projects are developed; the rest are placed in inventory waiting better prices or improved business conditions.

Australia has a rich uranium endowment that is related to the widespread occurrence of uranium enriched felsic igneous rocks (Lambert et al. 2005). Major



**Figure 6.17** Australian exploration expenditure and uranium spot prices in real dollars

**Source:** ABS 2009a, Ux Consulting 2009. Note: Expenditure and spot prices are quarterly figures

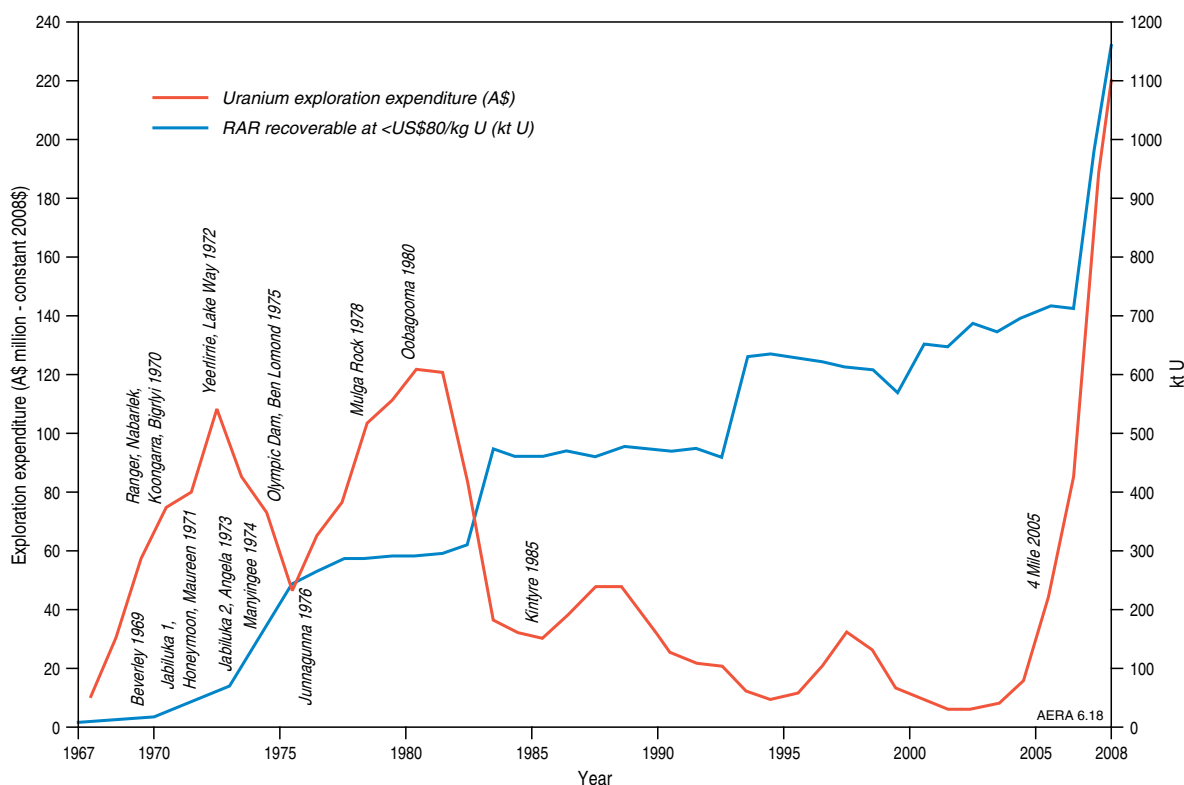


magmatic events during the Precambrian era (especially the Proterozoic) produced the greatest volumes of uraniumiferous igneous rocks, which are widespread in South Australia, Northern Territory and parts of Western Australia and Queensland. There is a clear spatial relationship between known uranium deposits and uranium-enriched bedrocks. While some uranium deposits, such as Olympic Dam, appear to have formed during these thermal events, most uranium deposits have formed from subsequent lower temperature processes that redistributed and concentrated the primary uranium to form new ore minerals.

In general, uranium mineralisation is younger than the spatially related igneous rocks. This is the case for sandstone, calcrete and unconformity related deposits that appear to have formed as a result of remobilisation of uranium from older-uranium enriched rocks. In particular, the Cainozoic calcrete deposits in the western part of the continent, including the large Yeelirrie deposit, are spatially related to the Archaean felsic rocks; and the unconformity related deposits are spatially associated with the Palaeoproterozoic to late Archaean felsic igneous rocks. Sandstone deposits are widely distributed in Australia. Those in the Frome Embayment, South Australia are believed to be derived from the adjacent exceptionally uranium-rich Proterozoic felsic rocks.

World uranium resources are dominated by sandstone, breccia complex and unconformity style deposits. Unconformity deposits are dominant in Australia and Canada. Australia has the world's largest resources of uranium recoverable at low cost, principally in the Olympic Dam hematite breccia deposit and the unconformity-related deposits of Ranger and Jabiluka. Major sandstone hosted uranium resources are known in Kazakhstan and the United States. Australia has only a small proportion of the world's resources in sandstone type deposits. In addition, uranium deposits related to magmatic processes appear under-represented in Australia given the abundance of uranium-rich igneous rocks (Skirrow et al. 2009).

There are no published estimates for Australia's undiscovered uranium resources. Geoscience Australia has undertaken a preliminary assessment of specific undiscovered uranium deposits related to sedimentary basins, such as unconformity and sandstone hosted deposits. This quantitative assessment for undiscovered uranium deposits was based on uranium ore density distribution in sedimentary basins that have the necessary geological features to form unconformity and sandstone type deposits. The assessment does not include the hematite breccia complex or calcrete deposits, which currently account for about 65 per cent and 5 per cent of Australia's uranium resources respectively.



**Figure 6.18** Australia's annual uranium exploration expenditure, discovery of deposits and growth of uranium resources

Source: Geoscience Australia

Geological settings considered favourable to host unconformity-related deposits, such as the Ranger deposit, exist in other areas in the Northern Territory and Western Australia. A quantitative assessment for those basins with all of the necessary geological features suggest that there is a 50 per cent probability that these basins contain up to 400 kt of undiscovered  $U_3O_8$  in unconformity-related deposits.

Australia has many large sedimentary basins, many of which have had only limited or no exploration for sandstone hosted uranium deposits. The known paleochannel sandstone hosted deposits are located in about 3 to 5 per cent of known paleochannels which means some 95 percent of paleochannels are unexplored and considered favourable for uranium mineralisation. It is reasonable to conclude that there is high potential for discovery of significant further sandstone hosted uranium resources in Australia. Recent intensive exploration has resulted in new discoveries such as Four Mile and Pepegooona (Beverley North) deposits in the Frome Embayment area, South Australia.

A quantitative assessment of suitable basins to host sandstone type deposits suggest that even if 10 per cent of the suitable basins were prospective there is a 50 per cent chance that these basins contain up to 370 kt  $U_3O_8$  in sandstone type deposits.

Regional and national assessments being undertaken as part of the Australian Government's Onshore Energy Security Program (OESP) are scheduled to finish in mid 2011 (Geoscience Australia 2007). The OESP is aimed at boosting investment in exploration, especially in greenfield areas, by delivering reliable, pre-competitive geoscience data. There are several outputs being delivered, some of which include:

- the radiometric map of Australia, which facilitates rapid assessment of uranium prospectivity from the national scale through to the local scale;
- geochemical survey of Australia, which provides

a nation-wide dataset on the geochemical composition of surface and near-surface materials;

- airborne electromagnetic (AEM) surveys, seismic acquisition and processing in under-explored areas that are considered to have potential for uranium and thorium mineralisation; and
- developing a new understanding of uranium mineralisation processes.

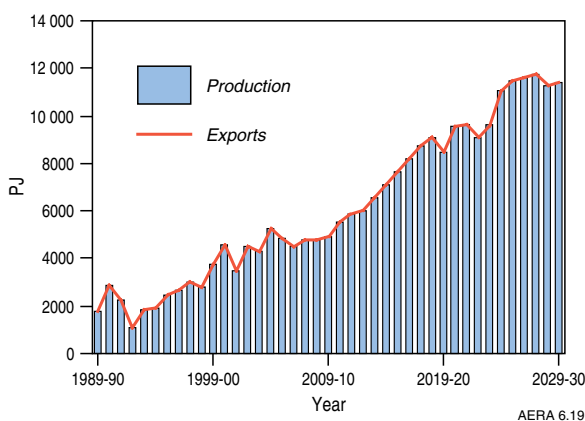
### Outlook for uranium market

#### Uranium supply-demand balance

In the medium to long term, Australia's production of uranium is expected to increase significantly, reflecting Australia's large low-cost uranium resources, proposed new mines and increasing world demand for uranium. World demand is projected to grow strongly over the outlook period given the projected strong growth in world nuclear electricity generation. Given that there are no plans for Australia to have a commercial nuclear power industry or enrichment facilities prior to 2030, all of Australia's uranium production will continue to be exported (figure 6.19).

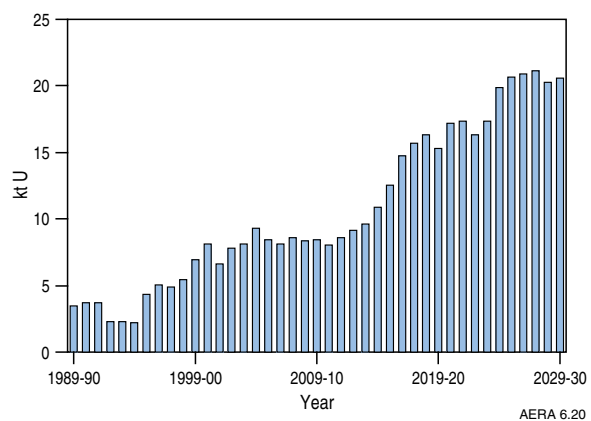
In the medium term, Australia's mine production is forecast to increase by around 8 per cent per year to reach 6170 PJ (11 kt U) by 2014–15 (ABARE 2010). Potential growth in uranium production is expected to come from Four Mile, Honeymoon, Oban and Crocker Well projects in South Australia and Yeelirrie, Kintyre, Lake Maitland and Wiluna uranium projects in Western Australia. In addition, plans are underway to expand underground operation at the existing Olympic Dam mine.

Based on planned projects and the likelihood of additional currently less advanced projects (discussed further below) entering production before 2030, ABARE projects Australian uranium



**Figure 6.19** Projection of Australia's uranium supply-demand balance to 2029–30

Source: ABARE



**Figure 6.20** Projection of Australia's uranium production to 2029–30

Source: ABARE

mine production will increase at an average annual rate of 12 per cent to around 11 760 PJ (21 kt U) by 2029–30 (figure 6.20). It should be noted that only uranium projects that have progressed to, or beyond, a pre-feasibility stage of development are included in this figure. Although other projects are likely to enter production over this period, they have not been included given the limited nature of information available on these projects. Projects that are likely to contribute most notably to this growth include the phased expansion of Olympic Dam and the development of Yeelirrie in Western Australia which collectively could add as much as 20 kt U to Australia's existing uranium mine capacity.

Australia's uranium exports are projected to increase in line with higher production, reaching 11 760 PJ by 2029–30.

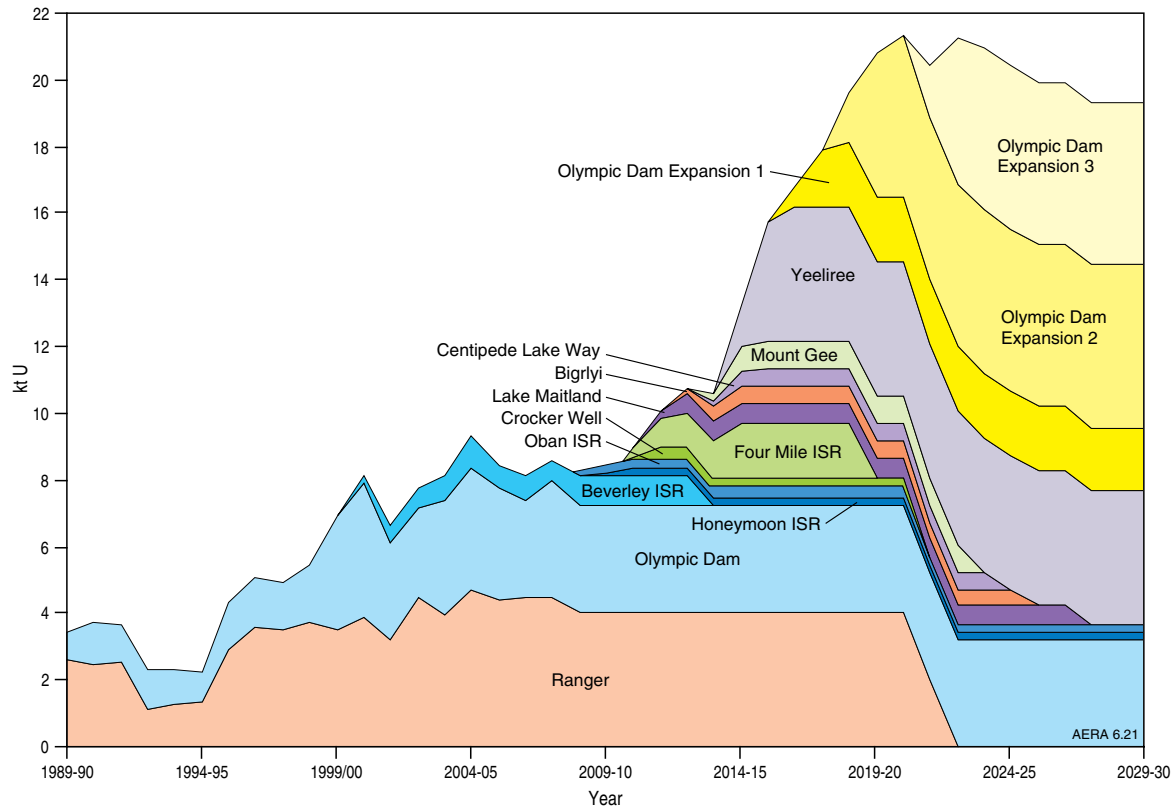
### Uranium project developments in Australia

Australia has a large number of uranium mining projects planned to enter production over the next decade (table 6.11, box 6.2). If all of these projects are realised, Australian uranium mine production capacity has the potential to increase from around 8.5 kt U per year up to 21.5 kt U by 2020–21. The supply forecasts are based on current reported resources. In practice, it is highly likely that additional ore reserves will be found and mine lives extended and possibly expanded. Figure 6.21 illustrates this potential growth in mine capacity, assuming all projects begin production at times announced by project developers. It should be noted that some of these projects will not be realised in the time frame announced; this is taken into account in ABARE's uranium production projections presented in figures 6.19 and 6.20.

**Table 6.11** Uranium development projects

Project	Company	Location	Status	Scheduled production start	Capacity kt U <sub>3</sub> O <sub>8</sub> /year (nominal)	Capital A\$m (nominal)
Honeymoon ISR	UraniumOne/ Mitsui	NE of Adelaide, SA	Under construction	2010	0.4	118
Four Mile ISR	Alliance Resources/ Quasar Resources	N of Adelaide, SA	Mine development approved	2010	1.36	112
Ranger pit extension	Energy Resources of Australia	E of Darwin, NT	Put on hold while alternative options are considered	2011	na	57
Olympic Dam expansion stage 1 - optimisation	BHP Billiton	Roxby Downs, SA	EIS under way	2016	4.5	na
Olympic Dam expansion stage 2	BHP Billiton	Roxby Downs, SA	EIS under way	2018	14.5	na
Olympic Dam expansion stage 3	BHP Billiton	Roxby Downs, SA	EIS under way	2021	19	na
Oban ISR	Curnamon Energy	N of Cockburn, SA	EIS under way	2010	0.2	na
Yeelirrie	BHP Billiton	N of Kalgoorlie, WA	EIS under way	2014	5	na
Crocker Well and Mount Victoria	Pepinnini Minerals/ Sino Steel	W of Broken Hill, SA	Feasibility study under way	2011	0.4	160
Bigrlyi	Energy Metals/ Paladin Energy	NW of Alice Springs, NT	Pre-feasibility study under way	2012	0.6	70
Wiluna (Centipede-Lake Way)	Toro Energy	SE of Wiluna, WA	Pre-feasibility study completed	2013	0.73	162
Valhalla	Summit Resources/ Paladin Resources	N of Mt Isa, Qld	On hold	na	Initially 2.7 Increasing 4.1	400
Lake Maitland	Mega Uranium / JAURD / Itochu	SE of Wiluna, WA	Scoping study completed	2012	0.75	102
Mt Gee	Marathon Resources	NE of Leigh Creek, SA	Scoping study completed	2013	1	400
Westmoreland	Laramide Resources	NW of Burketown, Qld	On hold	na	1.36	317

Source: ABARE 2009d



**Figure 6.21** Potential Australian uranium mine capacity

Source: ABARE

### BOX 6.2 URANIUM PROJECT DEVELOPMENTS IN AUSTRALIA

Projects that are expected to enter production during 2010 include Four Mile and Honeymoon operations in South Australia. Alliance Resources and Quasar Resources, a wholly owned subsidiary of Heathgate Resources, plan to develop the Four Mile ISR mining operation with the resin trucked 8 km to Heathgate Resources' Beverley plant for recovery of uranium (table 6.11). Production is scheduled to commence in 2010 with a projected production rate of 1.36 kt  $U_3O_8$  per year. Uranium One's Honeymoon ISR operation is planned to commence production in mid 2010. The operation is expected to produce 0.4 kt  $U_3O_8$  per year with a six year mine life. In addition, Curnamona Energy is undertaking ISR field leach trials at the small Oban deposit (65 km north of Honeymoon mine) and plans to be in commercial production in late 2010.

Of the major uranium projects planned, BHP Billiton's proposed Olympic Dam expansion is the largest. The proposed expansion will increase uranium production from the current capacity of 4 kt  $U_3O_8$  per year to approximately 19 kt  $U_3O_8$  per year. This expansion is

based on a very large open pit to mine the south-east portion of the deposit. Mining of ore from the open pit is currently scheduled to commence in 2016.

Energy Resources of Australia Ltd (ERA) is planning to construct a heap leach facility to process existing low-grade ore at its Ranger operations in the Northern Territory. A 10 million tonnes per year dynamic heap leach facility will be constructed to recover about 15–20 kt  $U_3O_8$  contained in low grade mineralised material. The leach solutions will be treated in a process similar to that used in the existing Ranger plant. In January 2009, ERA announced the discovery of a very significant ore body at depth adjacent to the current Ranger 3 operating pit. The company is planning an underground exploration drilling program to evaluate the extent and continuity of the ore body. A planned pit expansion has been put on hold while the underground option is explored.

## 6.3 Thorium

### 6.3.1 Background information and world market

#### Definitions

**Thorium (Th)** is a naturally occurring slightly radioactive metal, three to five times more abundant than uranium. The most common source of thorium is a rare earth phosphate mineral, monazite (WNA 2009i).

Thorium is a potential future nuclear fuel through breeding to  $U^{233}$ . Thorium has the potential to generate significantly more energy per unit mass of thorium than uranium (WNA 2009h).

Historically there has been only one commercial scale thorium-fuelled nuclear plant – the Fort St Vrain reactor in the United States that operated between 1976 and 1989. It was a high-temperature (700°C), graphite-moderated, helium-cooled reactor with a thorium/HEU fuel designed to operate at 330 megawatt electric (MWe) capacity. Almost 25 tonnes of thorium was used in fuel for the reactor (WNA 2009i).

Currently, there are no commercial scale thorium-fuelled reactors in the world and therefore no demand for thorium as a fuel. Any future large-scale commercial demand for thorium resources will depend on development of economically viable thorium-fuelled reactors.

#### Thorium supply chain

Figure 6.22 provides a representation of the potential thorium supply chain in Australia. As with uranium, the supply chain is divided into four distinct processes: resources exploration; development and production; processing transport and storage; and end use markets.

As most of the thorium resources in Australia are in known heavy mineral sand deposits, thorium production could be initiated with the recovery of thorium and rare earth elements from the monazite in operating heavy mineral sand mines without the need for an exploration phase.

#### World thorium market

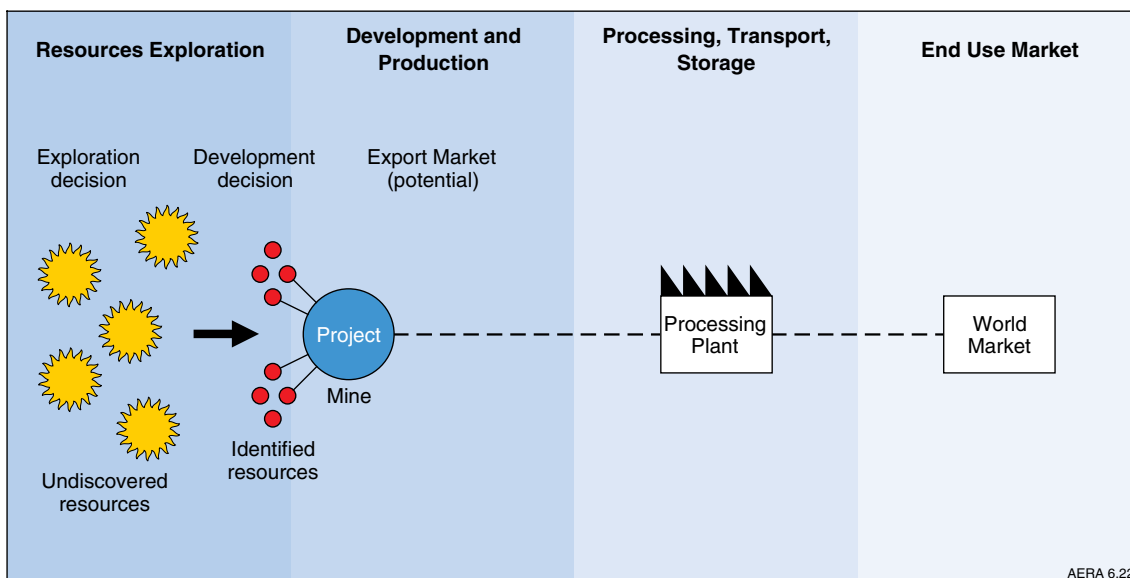
Currently, there are no commercial scale thorium-fuelled reactors. However research continues in countries with abundant thorium but little uranium resources.

#### Resources

Thorium resources are categorised according to the OECD/NEA-IAEA classification scheme. OECD/NEA-IAEA published in 2008 estimates of thorium resources on a country-by-country basis. The estimates are subjective because of variability in the quality of the data, much of which is old and incomplete. Table 6.12 has been derived by Geoscience Australia from information presented in the OECD/NEA-IAEA analysis. The total Identified Resources refer to RAR plus Inferred Resources recoverable at less than US\$80/kg thorium (US\$80/kg Th).

World RAR of thorium recoverable at less than US\$80/kg Th are estimated at 1.2 million tonnes, with total Identified Resources estimated at 2.6 million tonnes (OECD/NEA-IAEA 2008). However, in the absence of large scale demand for thorium, there is little incentive to undertake further work to convert Inferred Resources to RAR.

Australia's total recoverable Identified Resources of thorium amount to 490 kt (Geoscience Australia 2009), nearly one-fifth of total world identified thorium resources.



**Figure 6.22** Potential Australian thorium supply chain

Source: ABARE and Geoscience Australia



**Table 6.12** World total Identified Resources of thorium, 2007

Country	Reasonably Assured Resources <US\$ 80/kg Th		Inferred Resources <US\$ 80/kg Th		Total Identified Thorium Resources <US\$ 80/kg Th	
	kt	%	kt	%	kt	%
Australia	76	6.3	414	29.4	490	18.7
United States	122	10.1	278	19.7	400	15.3
Turkey	344	28.6	NA	NA	344	13.2
India	319	26.5	NA	NA	319	12.2
Brazil	172	14.3	130	9.2	302	11.6
Venezuela	NA	NA	300	21.3	300	11.5
Norway	NA	NA	132	9.4	132	5.1
Egypt	NA	NA	100	7.1	100	3.8
Russian Federation	75	6.2	NA	NA	75	2.9
Greenland	54	4.5	NA	NA	54	2.1
Canada	NA	NA	44	3.1	44	1.7
South Africa	18	1.5	NA	NA	18	0.7
Others	23	1.9	10	0.7	33	1.3
<b>Total</b>	<b>1203</b>	<b>100.0</b>	<b>1408</b>	<b>100.0</b>	<b>2610</b>	<b>100.0</b>

**Source:** Data for Australia compiled by Geoscience Australia; estimates for all other countries are from OECD/NEA-IAEA 2008

**Table 6.13** World and Australian thorium resources according to deposit type

Major deposit type	World		Australia	
	Resources (kt Th)	%	Recoverable Resources (kt Th)	%
Carbonatite	1900	31.3	24	4.9
Placer	1524	24.6	340	69.3
Vein-type	1353	21.4	73	14.9
Alkaline	1155	18.4	53	10.8
Other	258	4.2	-	-
<b>Total</b>	<b>6190</b>	<b>100.0</b>	<b>490</b>	<b>100.0</b>

Modified after OECD/NEA-IAEA (2008). Note: Australia's thorium resources expressed as 'recoverable' resources after an overall reduction of 10 per cent for mining

**Source:** Geoscience Australia

OECD/NEA-IAEA (2008) have grouped thorium resources according to four main types of deposits as shown in table 6.13. Thorium resources worldwide appear to be moderately concentrated in carbonatite type deposits (carbonate mineral rich intrusives), which account for about 30 per cent of the world total. The remaining thorium resources are more evenly spread across the other three deposit types in decreasing order of abundance, in placers (sand deposits), vein type deposits, and alkaline rocks. In Australia, a larger proportion of resources is located in placers, with heavy mineral sand deposits accounting for about 70 per cent of known thorium resources.

#### *World production, consumption and trade*

World production and consumption data are unavailable, but current production and consumption are thought to be negligible. There are at present no commercial scale thorium-fuelled reactors for

electricity generation in the world. Reasons for the lack of a thorium based nuclear fuel cycle in the past have included the high cost of thorium fuel fabrication and the abundance of cheap uranium fuel for the established uranium based reactors.

However, research into the thorium fuel cycle has continued, because it is considered to be less conducive to the proliferation of nuclear weapons, results in reduced nuclear waste, and represents increased energy security for countries with abundant thorium but little in the way of uranium resources. The construction of a 500 MWe prototype fast breeder reactor has commenced at Kalpakkam, India. This reactor will have a plutonium based core and a thorium-uranium (Th<sup>232</sup> – U<sup>238</sup>) blanket and will breed both U<sup>233</sup> from thorium and plutonium<sup>239</sup> (Pu<sup>239</sup>) from the uranium in the blanket. The reactor is expected to be operating in 2011. India is also planning to

complete a 300 MWe technology demonstration thorium-fuelled Advanced Heavy Water Reactor (AHWR) after 2017. However, full commercialisation of the AHWR is not expected before 2030.

### 6.3.2 Australia's thorium resources and market

Australia has the world's largest Identified Resources of thorium. Almost three quarters of Australia's thorium resources are in the mineral monazite within heavy mineral sand deposits.

#### Thorium resources

Geoscience Australia estimates Australia's monazite resources in the heavy mineral deposits to be around 6.2 million tonnes and inferred thorium resources in

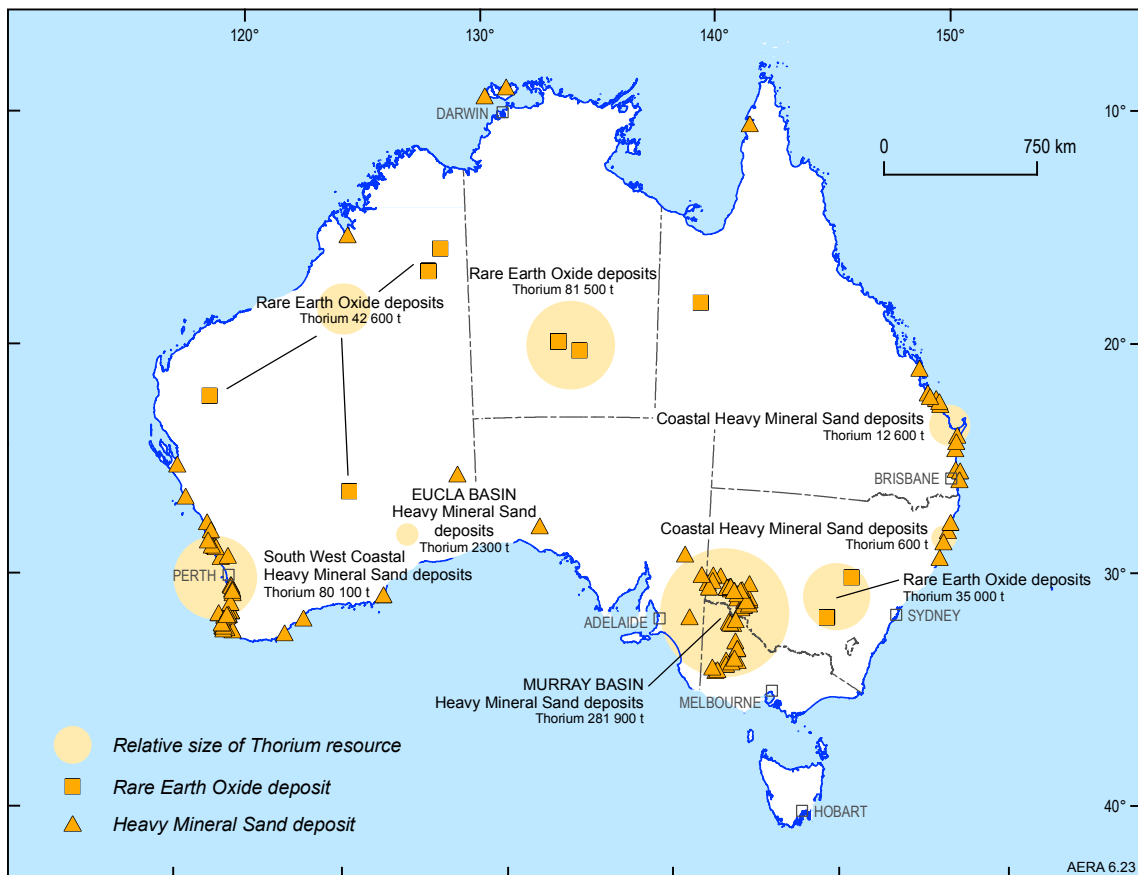
the heavy mineral sands are estimated to be around 377.7 kt Th. Australia's total indicated and inferred in situ resources, including those in predominantly rare earth element deposits, amount to about 544 kt Th (table 6.14).

As there are no publicly available data on mining and processing losses for extraction of thorium from these resources, the 'recoverable' resource of thorium is not known. However, assuming an arbitrary figure of 10 per cent for mining and processing losses in the extraction of thorium, then the 'recoverable' thorium resources could amount to about 489.6 kt Th. About 75.7 kt of this is RAR of recoverable thorium at less than US\$80/kg Th.

**Table 6.14** Australia's thorium resources, 2008

	unit	In situ	recoverable <US\$ 80/kg Th
Reasonably Assured Resources (RAR)	kt	84	75.6
Inferred Resources	kt	460	413.9
<b>Total Identified Resources</b>	<b>kt</b>	<b>544</b>	<b>489.6</b>

Source: Geoscience Australia 2009



**Figure 6.23** Australia's total in situ identified thorium resources

Source: Geoscience Australia

About three quarters of Australia's thorium resources are in the rare earth-thorium phosphate mineral monazite within heavy mineral sand deposits, which are mined for their ilmenite, rutile, leucoxene and zircon content (figure 6.23). Most of the known resources of monazite in mineral sands are in Victoria and Western Australia. The monazite in Australian heavy mineral sand deposits averages about 6 per cent thorium and 60 per cent rare earths. Prior to 1996, monazite was being produced from heavy mineral sand operations and exported for extraction of rare earths. Other thorium deposits are discussed in Box 6.3.

In current heavy mineral sand operations, the monazite is generally dispersed back through the original host sand (to avoid the concentration of radioactivity) when returning the mine site to an agreed land use. In doing so, the rare earths and thorium present in the monazite are negated as a resource because it would not be economic to recover the dispersed monazite for its rare earth and thorium content. The monazite content of heavy mineral resources is seldom recorded by mining companies in published reports.

### Thorium market

Historically, Australia has exported large quantities of monazite from heavy mineral sands mined in Western Australia, New South Wales and Queensland, for the extraction of both rare earths and thorium. Between 1952 and 1995, Australia exported 265 kt of monazite with a real export value (2008 dollars) of A\$284 million (ABS 2009b). However, since production ceased in 1995 it is believed no significant quantities of thorium, or materials containing thorium, have been imported or exported by Australia.

Production of monazite no longer occurs in Australia as the high disposal cost of thorium is considered to make the extraction of rare earths from monazite uneconomic.

### 6.3.3 Outlook to 2030 for Australia's resources and market

There is currently no large scale demand for thorium resources and therefore no comprehensive, reliable body of data either on resources or projected demand. Australia has a major share of the world's thorium resources, based on limited information available.

The full commercialisation of a thorium fuel cycle is unlikely to take place prior to 2030. As a result, large scale Australian production and subsequent trade of thorium are not likely within this time period. If commercialisation of a thorium fuel cycle occurs more quickly than assumed, Australia is well positioned to supply world markets with cheap reliable supplies of thorium. Large resources of thorium at deposits currently exploited for other minerals and the possible development of multi mineral deposits containing thorium are likely to support this production.

### Key factors influencing the outlook

There has been a significant renewal of interest in development of a thorium-fuelled nuclear cycle for electricity generation, partly because of the relative abundance of thorium, its greater resistance to nuclear weapons proliferation and the substantial reduction in radioactive waste generated from a thorium-fuelled nuclear cycle. However, much work remains to be done before a commercial scale thorium-fuelled reactor for electricity generation can become a reality.

#### BOX 6.3 THORIUM DEPOSITS IN AUSTRALIA

Apart from heavy mineral sand deposits (placer deposits), thorium is present in other geological settings such as alkaline intrusions and in veins and dykes.

A significant example is the Nolans Bore rare earth, phosphate uranium deposit which occurs in veins and dykes north of Alice Springs in the Northern Territory. This deposit contains about 81.8 kt of thorium.

The Yangibana dykes (termed 'ironstones'), northeast of Carnarvon in Western Australia, crop out over an area of 500 km<sup>2</sup>. Whole rock chemical analyses of a number of ironstone samples record more than 1000 parts per million of thorium.

In New South Wales, the Toongi intrusive, south of Dubbo, hosts a 35.7 million tonnes of measured

resources and 37.5 million tonnes of Inferred Resources at a grade of 0.0478 per cent thorium, giving a total of about 35 kt contained thorium.

Other alkaline complexes with known rare earth and thorium mineralisation include Brockman in Western Australia. Exploration reports indicate thorium occurrences, but no estimates of thorium resources have been reported.

Data on the thorium content of carbonate mineral rich intrusions in Australia are sparse. Mount Weld and Cummins Range deposits in Western Australia are both known to contain some thorium.

**Source:** Geoscience Australia 2009.

### *Technology developments – future development of thorium reactors*

Demand for thorium resources depends upon the development and widespread adoption of thorium-fuelled reactors for electricity generation. The main drivers for interest in thorium-fuelled reactors are:

- Some countries, such as India, have much larger thorium resources than uranium and see thorium-fuelled reactors as a more secure source of energy.
- The thorium fuel cycle is considered to be less conducive to nuclear weapon proliferation than the uranium fuel cycle.
- The thorium fuel cycle generates much less radioactive waste than the uranium fuel cycle.

Current research and development for use of thorium in reactors for electricity generation are directed primarily towards:

- Research into thorium fuel designed to be used in currently operating uranium-fuelled reactors.
- Development and construction of a purpose-built thorium-fuelled reactor for electricity generation.
- Development of some other advanced nuclear reactors which could use thorium fuels.

Further details of the research and developments are presented in Box 6.4.

### *Cost competitiveness*

As there is no established large scale demand and associated price information for thorium, there is

insufficient information to determine how much of Australia's thorium resources are economically viable for electricity generation in thorium reactors.

However, as all of Australia's thorium resources occur either in the heavy mineral sand deposits or in rare earth mineral deposits, mining and processing cost for the extraction of thorium would be shared with other commodities.

### *Infrastructure, environment and other issues*

Most thorium resources are contained in heavy mineral sand deposits and rare earth deposits that already have essential infrastructure. Some of these deposits are currently being mined or in advanced stages of development with infrastructure costs being borne by commodities being extracted.

Apart from improved resistance to proliferation of nuclear weapons, a thorium fuel cycle is generally considered to generate less radioactive waste and has fewer long-lived transuranic elements. The extent of these potential advantages over the current uranium fuel cycle varies according to different designs of the thorium fuel cycle.

There are little readily available nuclear industry data on the issues of nuclear proliferation and volumes and storage of nuclear waste because there are no currently operating commercial scale thorium-fuelled reactors.

## **BOX 6.4 R&D THORIUM PROJECTS**

### *Thorium fuel design*

At this stage it appears that thorium fuel could be used in existing uranium-fuelled reactors such as the latest Canadian CANDU reactors or possibly the Russian VVER-1000 reactors. This would involve using thorium fuels designed by Lightbridge Corporation (formerly Thorium Power Ltd), possibly by 2020 (Thorium Power Ltd 2009).

Atomic Energy of Canada Ltd (AECL) is moving towards certification of an Advanced CANDU Reactor (ACR) 1000 (Generation III+ 1200 MWe) in Canada. The earliest in-service date for an ACR 1000 is 2016. It is anticipated that use of thorium fuel will be introduced at a later stage. In mid 2009, AECL signed agreements with three Chinese entities to develop and demonstrate the use of thorium fuel in its CANDU reactors at Qinshan in China. Another agreement in mid 2009 between Areva and Thorium Power Ltd will assess the use of thorium fuel in Areva's European Pressurised Reactor (EPR), drawing upon earlier research.

Thorium Power Ltd is preparing preliminary licensing documentation for its thorium fuel assembly design for use in the current Russian VVER-1000 reactors

(Thorium Power Ltd 2009). The timeframe for this work is unknown. Two VVER-1000 reactors are currently being built in India, which has extensive thorium resources but very limited uranium resources.

### *Thorium-fuelled reactors*

A purpose built thorium-fuelled reactor – the Indian 300 MWe Advanced Heavy Water Reactor (AHWR) – has been proposed for construction as a technical demonstration. The AHWR will have fuel assemblies of 30 Th-U<sup>233</sup> oxide pins and 24 plutonium-Th oxide pins around a central rod with burnable absorber. It is designed to be self-sustaining in relation to U<sup>233</sup> bred from Th<sup>232</sup> and have a low plutonium inventory and consumption. It is designed for a 100 year plant life and is expected to utilise 65 per cent of the energy of the fuel, with two thirds of the energy coming from thorium. The technical demonstration version is expected to be completed some time after 2017, but full scale commercial AHWR reactors are not anticipated before 2030.

In 2009 India announced an export version of the AHWR – the AHWR-LEU. This design will use low-enriched uranium plus thorium as a fuel, dispensing

with the plutonium input. About 39 per cent of the power will come from thorium (via in situ conversion to  $U^{233}$ ). The uranium enrichment level will be 19.75 per cent, giving 4.21 per cent average fissile content of the U-Th fuel. Plutonium production will be less than in light water reactors, and the fissile proportion will be less, providing inherent proliferation resistance benefits (WNA 2009g; Kakodkar 2009).

India is the only country that has been involved in development of a full scale thorium reactor, the AHWR in stage 3. This program had a high priority while India was under an international trade ban for nuclear technology and on imports of uranium. The Nuclear Suppliers' Group agreement in September 2008 and the United States-India nuclear agreement in October 2008 now allow India to trade in nuclear technology and import uranium fuel. In addition, India has also signed a nuclear cooperation agreement with France. It is unclear if India will maintain a high priority on the development of its thorium fuel cycle.

#### Advanced reactors

Generation IV reactors will also be capable of using thorium fuel in the high-temperature gas-cooled reactors (HTGRs) or the molten salt reactors (MSR).

There are two types of high temperature gas-cooled reactors (HTGRs): prismatic fuel and pebble bed. General Atomics is developing a Gas Turbine-Modular Helium Reactor (GT-MHR) that uses a prismatic fuel. The GT-MHR core can accommodate a wide

range of fuel options, including HEU/Th,  $U^{233}$ /Th and Plutonium/Th. Pebble bed reactor development builds on previous work in Germany and is under development in China and South Africa. A pebble bed reactor can potentially use thorium in the fuel pebbles.

The molten salt reactor (MSR) is an advanced breeder concept, in which the coolant is a molten salt, usually a fluoride salt mixture. The fuel can be dissolved enriched uranium, thorium or  $U^{233}$  fluorides. The fission products dissolve in the salt and are removed continuously in an online reprocessing loop and replaced with  $Th^{232}$  or  $U^{238}$ . Actinides remain in the reactor until they fission or are converted to higher actinides which do so. The MSR was originally studied in depth in the 1960s, but is now being revived because of the availability of advanced technology for the materials and components. There is renewed interest in the MSR concept in Japan, the Russian Federation, France and the United States and the MSR is one of the six Generation IV designs selected by the international forum of 13 countries for further development.

As with a purpose built thorium-fuelled reactor, these advanced HTGR and MSR reactors are not likely to come on stream much before 2030, and the extent to which they will use thorium rather than uranium is also uncertain.

## 6.4 References

- ABARE (Australian Bureau of Agricultural and Resource Economics), 2006, Uranium, Global Market Developments and Prospects for Australian Exports, Canberra
- ABARE, 2009a, 'Uranium', Australian Commodities, vol 16 no 1, March quarter, pp. 158-166, Canberra, March
- ABARE, 2009b, Australian Energy Statistics, Canberra, August
- ABARE, 2009c, Australian Mineral Statistics, Canberra, September
- ABARE, 2009d, Minerals and energy, major development projects – October 2009 listing, Canberra, November
- ABARE, 2009e, Australian Commodity Statistics 2009, Canberra, December
- ABARE, 2010, Australian Commodities, vol 17, no 1, March quarter, Canberra, March
- ABS (Australian Bureau of Statistics), 2009a, Mineral and Petroleum Exploration, June quarter 2009, Cat. No 8412.0, Canberra, <<http://www.abs.gov.au>>
- ABS, 2009b, International trade, Cat. No. 5465.0, Canberra
- ANSTO (Australian Nuclear Science and Technology Organisation), 2006, Introducing Nuclear Power to Australia: an economic comparison, Canberra, <<http://www.ansto.gov.au>>
- ASNO (Australian Safeguards and Non-proliferation Office), 2009, Annual report 2008–09, Canberra, <[http://www.asno.dfat.gov.au/annual\\_reports.html](http://www.asno.dfat.gov.au/annual_reports.html)>
- Australian Uranium Association, 2008, Outlook for the Uranium Industry — Evaluating the economic impact of the Australian uranium industry to 2030, Sydney, <<http://www.auran.org.au>>
- Commonwealth of Australia, 2006a, Uranium Mining, Processing and Nuclear Energy — Opportunities for Australia?, Report to the Prime Minister by the Uranium Mining, Processing and Nuclear Energy Review Taskforce, December 2006
- Commonwealth of Australia, 2006b, Uranium Industry Framework, Canberra, <[http://www.ret.gov.au/resources/mining/australian\\_mineral\\_commodities/uranium/Pages/Uranium.aspx](http://www.ret.gov.au/resources/mining/australian_mineral_commodities/uranium/Pages/Uranium.aspx)>
- Commonwealth of Australia, 2006c, Australia's uranium – Greenhouse friendly fuel for an energy hungry world, Canberra
- EIA (Energy Information Administration), 2009a, International Energy Outlook 2009, <<http://www.eia.doe.gov/oiaf/ieo/index.html>>
- EIA, 2009b, Nuclear Power: 12 percent of America's Generating Capacity, 20 percent of the Electricity, <<http://www.eia.doe.gov/cneaf/nuclear/page/analysis/nuclearpower.html>>
- Euratom Supply Agency, 2009, Annual Report 2008, European Commission, Luxembourg, <<http://ec.europa.eu/euratom>>
- Geoscience Australia, 2009, Australia's Identified Mineral Resources, 2009, Geoscience Australia, Canberra, <<http://www.australianminesatlas.gov.au/aimr/index.jsp>>



Geoscience Australia, 2007, Onshore Energy Security Program 5 Year Plan, <[http://www.ga.gov.au/image\\_cache/GA10075.pdf](http://www.ga.gov.au/image_cache/GA10075.pdf)>

IAEA (International Atomic Energy Agency), 2009, Power Reactor Information System (PRIS), <<http://www.iaea.org/programmes/a2/>>

IEA (International Energy Agency) 2009, World Energy Balances, OECD, Paris, <<http://www.iea.org>>

Kakodkar A, 2009, Statement by Dr Anil Kakodkar, Chairman of the Atomic Energy Commission and leader of the Indian delegation, IAEA 53rd General Conference, Vienna, 16 September 2009

Lambert I, Jaireth S, McKay A, and Mieztis Y, 2005, Why Australia has so much uranium, AusGeo News, Issue 80, December 2005

Metals Economics Group, 2009, Corporate Exploration Strategies study, <<http://www.metalseconomics.com/default.htm>>

OECD/NEA (Nuclear Energy Agency) and IAEA (International Atomic Energy Agency), 2006, Forty Years of Uranium Resources, Production and Demand in Perspective, The Red Book Retrospective, OECD/NEA-IAEA, Paris

OECD/NEA and IAEA, 2008, Uranium 2007: Resources, Production and Demand, OECD/NEA-IAEA, Paris, <<http://www.nea.fr/index.html>>

Schodde R, and Trench A, 2009, Benchmarking uranium projects; How do the next generation of mines compare to current operations?, AusIMM International Uranium Conference, June 2009, Darwin, Northern Territory

Skirrow RG, Jaireth S, Huston DL, Bastrakov EN, Schofield A, van der Wielen SE, Barnicoat AC, 2009, Uranium mineral systems: Processes, exploration criteria and a new deposit framework, Geoscience Australia, Record 2009/20

Thorium Power Limited, 2009, Annual shareholders meeting, 29 June 2009, <<http://ir.thoriumpower.com/phoenix.zhtml?c=121550&p=irol-irhome>>

TORO Energy Limited, 2008, Presentation to investors and shareholders, 16 October 2008, <<http://www.toroenergy.com.au/presentations.html>>

Ux Consulting 2009, Historical Ux Price Data, <[http://www.uxc.com/c/prices/uxc\\_prices-mth-historic.xls](http://www.uxc.com/c/prices/uxc_prices-mth-historic.xls)>

Ux Consulting, Uranium Market Outlook, Quarterly report, UxC, Roswell, Ga, <<http://www.uxc.com>>

WNA (World Nuclear Association), 2005, The New Economics of Nuclear Power, WNA, London, <<http://www.world-nuclear.org/reference/pdf/economics.pdf>>

WNA, 2008, WNA Market Report, London, <<http://www.world-nuclear.org/reference/publications.html>>

WNA, 2009a, The Nuclear Fuel Cycle, January 2009, <<http://www.world-nuclear.org/info/inf03.html>>

WNA, 2009b, World uranium mining, July 2009, <<http://www.world-nuclear.org/info/default.aspx?id=430&terms=uranium+production>>

WNA, 2009c, World Nuclear Power Reactors 2007–09 & Uranium Requirements, December 2008, <<http://www.world-nuclear.org/info/reactors-dec2008.html>>

WNA, 2009d, The Global Nuclear End Market – Supply and Demand 2009–2030

WNA, 2009e, Processing of used nuclear fuel, September 2009, <<http://www.world-nuclear.org/info/inf69.html>>

WNA, 2009f, World nuclear power reactors and uranium requirements, October 2009, <<http://www.world-nuclear.org/info/reactors.html>>

WNA, 2009g, Generation IV nuclear reactors, August 2009, <<http://www.world-nuclear.org/info/default.aspx?id=530&terms=Generation+IV>>

WNA, 2009h, Advanced Nuclear Power Reactors, September 2009, <<http://www.world-nuclear.org/info/default.aspx?id=528&terms=advanced+nuclear+reactors>>

WNA, 2009i, Thorium, November 2009, <<http://www.world-nuclear.org/info/inf62.html>>

# Chapter 7

## Geothermal Energy



### 7.1 Summary

#### KEY MESSAGES

- Geothermal energy is a major resource and potential source of low emissions renewable energy suitable for base-load electricity generation and direct-use applications.
- Australia has significant potential geothermal resources associated with buried high heat-producing granites and lower temperature geothermal resources associated with naturally-circulating waters in aquifers deep in sedimentary basins.
- Most current geothermal projects in Australia are still at proof-of-concept or early commercial demonstration stage.
- Demonstration of the commercial viability of geothermal energy in Australia will assist in attracting the capital investment required for geothermal energy development. The development of some remote geothermal resources will require additional transmission infrastructure.
- Geothermal energy is projected to produce around 6 TWh in 2029–30. Electricity supply is likely to be from demonstration plants initially but commercial-scale geothermal energy production is expected by 2030.

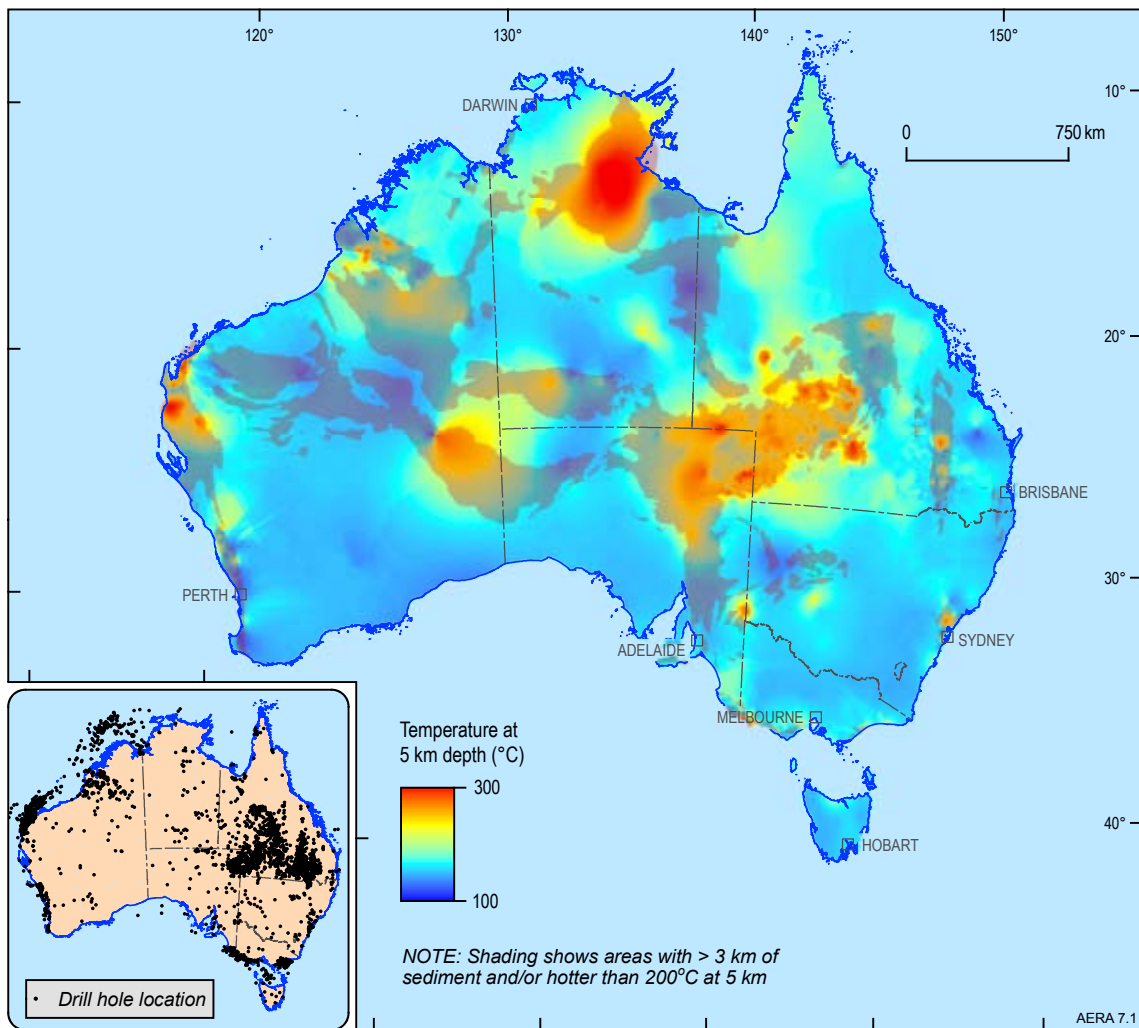
#### 7.1.1 World geothermal resources and market

- Electricity has been produced commercially from geothermal resources for over 100 years. Conventional geothermal resources are based on hydrothermal systems associated with active volcanism, which Australia lacks.
- Significant geothermal resources can also be associated with basement rocks heated by natural radioactive decay of elements (such as uranium, thorium and potassium) and in naturally-circulating waters deep in sedimentary basins.
- Geothermal energy is used in many countries for electricity generation and heat production (91 per cent) and in direct-use applications (9 per cent), but accounted for only 0.4 per cent of total primary energy consumption in 2007.
- Geothermal energy has the potential to sustainably provide large amounts of low-emission base-load electricity generation, and can also be used to power industrial processes via direct-use applications (including desalination distillation, district heating and cooling), and for ground source heat pumps.
- Government policies, energy prices and falling investment costs and risks are projected to be the main factors underpinning future growth in world geothermal energy use.

- World electricity generation from geothermal energy is projected by the IEA in its reference case to increase at an average annual rate of 4.6 per cent between 2007 and 2030 to reach 173 TWh or around 0.5 per cent of total electricity generation. Most of this increase is projected to come from projects in the United States and non-OECD Asia.

#### 7.1.2 Australia's geothermal resources

- Australia has considerable Hot Rock geothermal energy potential. This results from the widespread occurrence of basement rocks (granites in particular) in which heat is generated by natural radioactive decay. Where high heat-producing rocks occur beneath thick blankets of thermally insulating strata, the thermal energy is retained in the basement rocks and overlying strata causing elevated temperatures at relatively shallow depths. There are extensive areas where temperatures are estimated to reach at least 200°C at around 5 km depth (figure 7.1).
- There is also potential for lower temperature geothermal resources associated with naturally-circulating waters in aquifers deep in a number of sedimentary basins (Hot Sedimentary Aquifer geothermal). These are potentially suitable for electricity generation and direct use.



**Figure 7.1** Predicted temperature at 5 km depth based mostly on bottom-hole temperature measurements in more than 5000 petroleum and water boreholes

**Source:** Data from Earth Energy Pty Ltd; AUSTHERM database; Geoscience Australia

- A geothermal power plant has been periodically in operation at Birdsville, Queensland, since 1992. It uses a bore that produces water from the Great Artesian Basin at 98°C at surface to generate approximately 80 kW net, supplying about 30 per cent of the total plant output with the remainder being fuelled by diesel and LPG.
- Australia's overall geothermal potential has only recently been appreciated. Consequently, there are significant gaps in the information required to adequately assess potential. It is likely that additional new data will lead to increases in the geothermal resource base.
- As of July 2009 eight companies have declared identified geothermal resources totalling 2.6 million PJ of heat in place.

### 7.1.3 Key factors in utilising Australia's geothermal resources

- Government policies relating to geothermal energy research, development and demonstration

(RD&D) are critical to the outlook for electricity generation from geothermal energy. The Australian Government's Renewable Energy Demonstration Program and Geothermal Drilling Program are key contributors.

- The demonstration of the economic viability of the extraction and use of geothermal energy both for electricity generation and direct use is critical to attract the capital investment required.
- Improved information on geothermal energy potential in many parts of Australia – especially new geoscientific data designed to locate regions with temperature anomalies at relatively shallow depths (1-4 km) – would aid definition of geothermal resources and reduce exploration costs.
- There is significant potential for energy savings through greater use of ground source heat pumps in heating and cooling buildings in many regions of Australia.

### 7.1.4 Australia's geothermal energy market

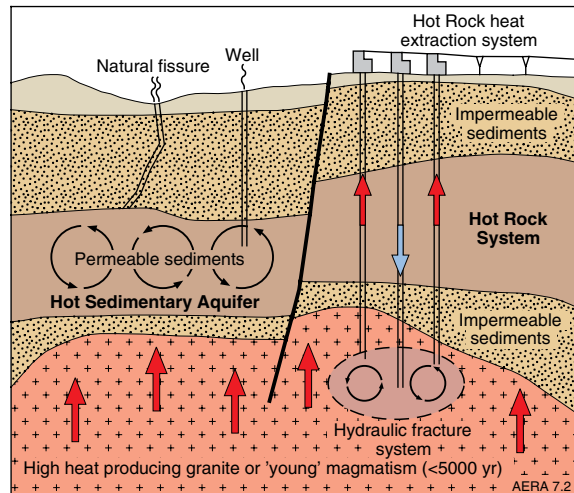
- There are uncertainties in the outlook for geothermal power over the next two decades. A major uncertainty is the cost of electricity production as the technology has yet to be proven commercially viable. Present estimates show a wide range in the cost of geothermal electricity generation, reflecting the current pre-commercial stage of the industry, as the cost of electricity generation is highly dependent on future technology developments and grid connection issues.
- The geothermal industry in Australia is progressing, with proof-of-concept having been attained in one project and expected to be achieved in at least two others within one to two years. Several pilot projects are expected to be completed within five years.
- Progress is being assisted by government grants to developing geothermal projects. Two geothermal projects were awarded grants in November 2009 totalling \$153 million under the Australian Government's Renewable Energy Demonstration Program; the Australian Government Geothermal Drilling Program has announced \$49 million in grants to support seven proof-of-concept projects; and the Victorian Government has announced \$25 million to support a demonstration project.
- In ABARE's latest long-term energy projections, which include the Renewable Energy Target, a 5 per cent emissions reduction target and other government policies, geothermal electricity generation in Australia is projected to increase by 18.4 per cent per year, to reach around 6 TWh in 2029–30 and account for around 1.5 per cent of total electricity generation.

## 7.2 Background information and world market

### 7.2.1 Definitions

**Geothermal energy** is heat (thermal) derived from the Earth (geo). Geothermal energy is an abundant, clean (effectively no greenhouse gas emissions) and reliable (renewable or sustainable) natural resource. There is a steady flow of heat from the centre of the Earth (where temperatures are above 5000°C) through the surface of the Earth (-30 to +40°C) into space (-273°C): heat flows from hot to cold. The heat is generated by the natural decay over millions of years of radiogenic elements including uranium, thorium and potassium.

Geothermal resources that have been utilised, or are prospective for development, range from shallow ground to hot water and rock several kilometres below the Earth's surface (Energy and Geoscience Institute 2001).



**Figure 7.2** Hot Rock and Hot Sedimentary Aquifer systems

**Source:** Ayling et al. 2007a

It is useful to distinguish between hydrothermal and other geothermal resources:

- **Hydrothermal resources** use naturally occurring hot water or steam circulating through permeable rock – these conventional geothermal systems are usually based on hydrothermal aquifers commonly associated with active or young volcanic systems. Hydrothermal resources have been used in a range of applications (discussed further later). Australia lacks hydrothermal resources as it has no active volcanism on the mainland.
- **Hot Rock and Hot Sedimentary Aquifer** geothermal resources are of particular interest to Australia (figure 7.2). Research over the past 30 years has demonstrated that non-volcanic areas may have potential for Hot Rock resources (also known as enhanced geothermal systems); that produce super-heated water or steam by artificially circulating fluid through the rock. Hot Sedimentary Aquifers are found in areas where high temperatures are reached at depths shallow enough for natural porosity and permeability in sedimentary rocks to be preserved so that fluid circulation can occur without artificial enhancement. It is now evident that Australia has good Hot Rock geothermal energy potential, as well as a significant potential for Hot Sedimentary Aquifer resources. Geothermal systems that are similar to Australia's Hot Sedimentary Aquifer systems have been used elsewhere in the world for electricity generation and direct-use applications for over 20 years.

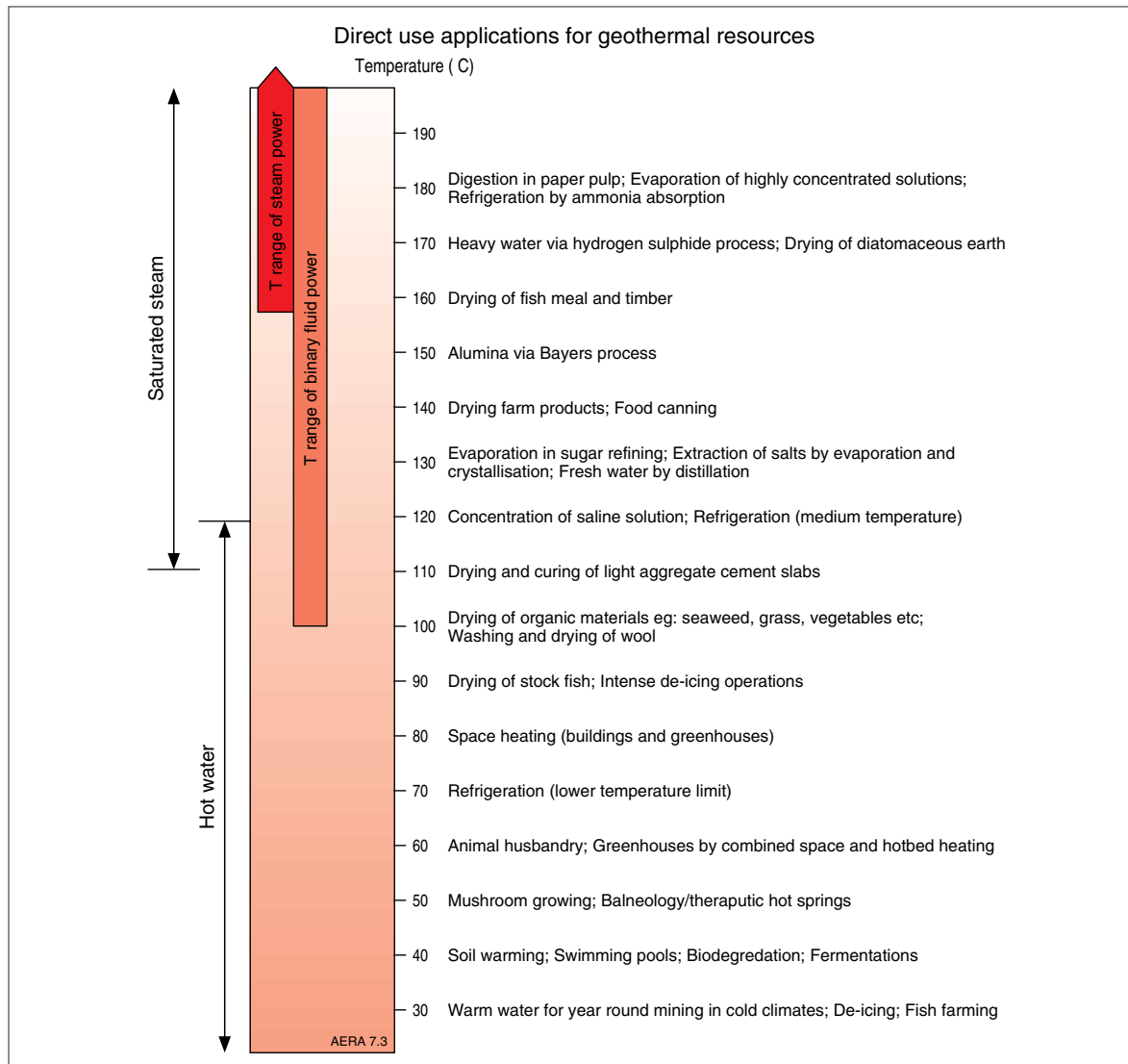
There are three basic requirements for a geothermal resource:

1. a persistent heat source (or sink);
2. a heat transfer and transport medium (usually water and/or steam); and
3. sufficient permeability/transportability within the buried geothermal reservoir for the fluid to be able to pass through and gain (or lose) heat.

To some degree, the natural conditions can be modified. There is a large range of heat conversion technologies available, so that geothermal resources of almost any temperature can be utilised. If insufficient volumes of water exist naturally, this can be added. Permeability can be artificially enhanced, or pipes can be used in shallow systems.

Geothermal resources (excluding ground source heat pumps) may be classified broadly according to temperature – high temperature (greater than 170°C), moderate temperature (90°C to 170°C) and low temperature (less than 90°C) – which influences the uses to which they may be applied (Geothermal Resources Council 2009). High temperature systems are often exploited for electricity generation, while low temperature systems are more suited to direct-use applications (figure 7.3). High and moderate temperature systems may be used for both electricity generation and direct-use applications in a cascading fashion.

**Electricity generation** – hydrothermal systems are currently utilised in several countries for electricity generation. Geothermal power plants can provide base-load capacity 24 hours a day and have very high long-term capacity and availability factors. Current technologies (Box 7.1) include dry steam plants (uses steam at greater than 235°C through production wells), flash steam plants (use hot water at temperatures in the range 150°C to 300°C) and binary-cycle plants (used for moderate temperature geothermal reservoirs between 100°C and 180°C). Temperature is only one parameter used to determine which conversion technology is utilised for any geothermal reserve (box 7.1). Electricity generation from geothermal water was pioneered at Larderello, Italy in 1904, and this steam field has been in continuous production since that time. The Wairakei geothermal power plant, located in New Zealand, built in 1958 – the second geothermal power station built in the world and the first to use hot pressurised water



**Figure 7.3** Direct-use applications of geothermal energy

**Source:** Geoscience Australia modified after Lindal 1973; Ayling et al. 2007b



– has generated electricity for more than 50 years. The largest geothermal development in the world at The Geysers in California, United States, has an output capacity of 750 MW based on 22 separate power plants, some of which have been in operation for nearly 50 years.

**Direct-heat uses for geothermal waters** – hot water may be piped directly into facilities for use in a range of applications such as district (and large commercial buildings) heating and greenhouses, heating water for fish farming (aquaculture), drying crops and building materials, and for use in resorts and spas (figure 7.3). The heat may be used directly in industrial processes including drying, for absorption chillers (including airconditioning), and in desalination of sea water by distillation. People have traditionally used hot water from geothermal springs for bathing, cooking and heating; for example, the Romans used geothermal waters at Bath in England.

**Ground source heat pumps (GSHP) that utilise the ground as a heat source/sink** – these systems are a direct-use technology that use the ground as a heat

source or sink rather than natural hot water (i.e. they do not use ‘geothermal resources’) and are used to heat and cool buildings. Heat is extracted from the ground and delivered to the building in winter (heating mode) and heat is removed from the building and delivered for storage into the ground in summer (cooling mode). The GSHP is electric powered to circulate heat-carrying fluid, but energy consumption is significantly reduced compared with conventional heating and cooling systems.

### 7.2.2 Geothermal energy supply chain

Figure 7.5 is a schematic representation of the potential geothermal energy market in Australia. At present geothermal energy resources are used only in limited local-scale applications in Australia. High and moderate temperature geothermal energy resources (Hot Rock and Hot Sedimentary Aquifer) may be utilised to produce base-load electricity for distribution through the transmission grid. In addition, lower temperature geothermal energy resources, particularly those found in shallow sedimentary aquifers, could be used for direct-use applications. Ground source heat pumps could be

#### BOX 7.1 GEOTHERMAL ENERGY TECHNOLOGIES FOR ELECTRICITY GENERATION

Current geothermal technologies for electricity generation are:

- **Flash steam plants** are used where abundant high temperature water or vapour is available. Hot water is removed from the production well and sprayed into a separator (tank) held at a much lower pressure, causing some of the water to flash to steam (vaporise). The steam is used to drive the turbine and then condensed back to water and injected back into the reservoir.
- **Dry steam plants** use steam resources at temperatures of about 250°C. The steam goes directly to a turbine which drives a generator that produces electricity. This was originally used in Larderello, Italy, and is the technology used at the world’s largest geothermal power field, at The Geysers in California, United States.
- **Binary power plants** (figure 7.4) use a heat exchanger to transfer energy from the geothermally-heated fluid to a secondary fluid (‘working fluid’, e.g. iso-pentane or ammonia-water mix) that has a lower boiling point and higher vapour pressure than steam at the same temperature. The working fluid is vaporised as it passes through the heat exchanger, and then expanded through a turbine to generate electricity. It is then cooled and condensed to begin the cycle again. The cooled geothermal fluid is also recirculated into the ground: the system comprises two closed loops.

Australia’s geothermal systems are neither hot enough nor under sufficient pressure to sustainably produce large amounts of steam. Most Australian geothermal resources will be exploited using binary power generation systems, even those with temperatures of over 200°C.

Electricity generation costs are strongly influenced by the temperature and flow rate of the geothermal fluid produced, which dictates the size of the turbine, heat exchangers and cooling system. Access to the electricity grid is also an important cost consideration for electricity generation projects.

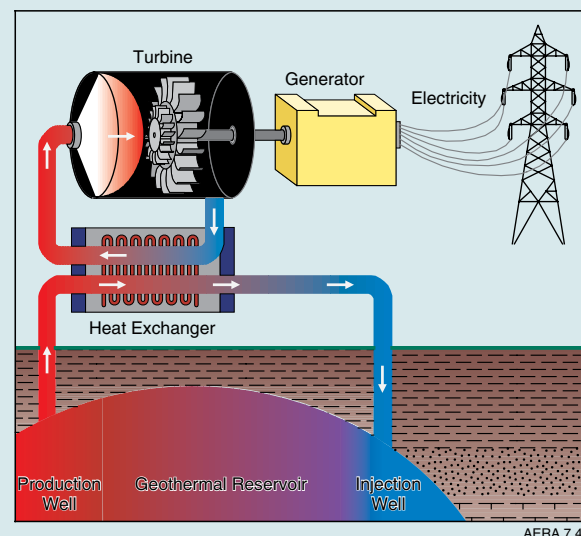


Figure 7.4 Design of a binary cycle power plant

Source: Geoscience Australia

employed almost anywhere and on a range of scales to provide building heating and cooling.

Key stages in the geothermal energy supply chain are discussed further in Box 7.2.

Important elements of Hot Rock (and, to a lesser extent, Hot Sedimentary Aquifer) geothermal energy developments are the definition of the geothermal resource by deep drilling and establishing a geothermal reservoir in the geothermally-heated rocks. The artificial creation of geothermal reservoirs in the hot rocks for water to flow through is commonly

called ‘engineered or enhanced geothermal systems’ (EGS) and involves fracturing the hot rock in a process known as ‘hydrofracturing’. Once the reservoir in the hot rock is created and the flow of water established in a closed loop, the geothermal resource can be used to generate electricity using the technologies described in Box 7.1 and the electricity connected to the transmission grid for distribution.

### 7.2.3 World geothermal energy market

The world has vast, largely unutilised geothermal energy resources. Geothermal energy currently accounts for only a small share of world primary

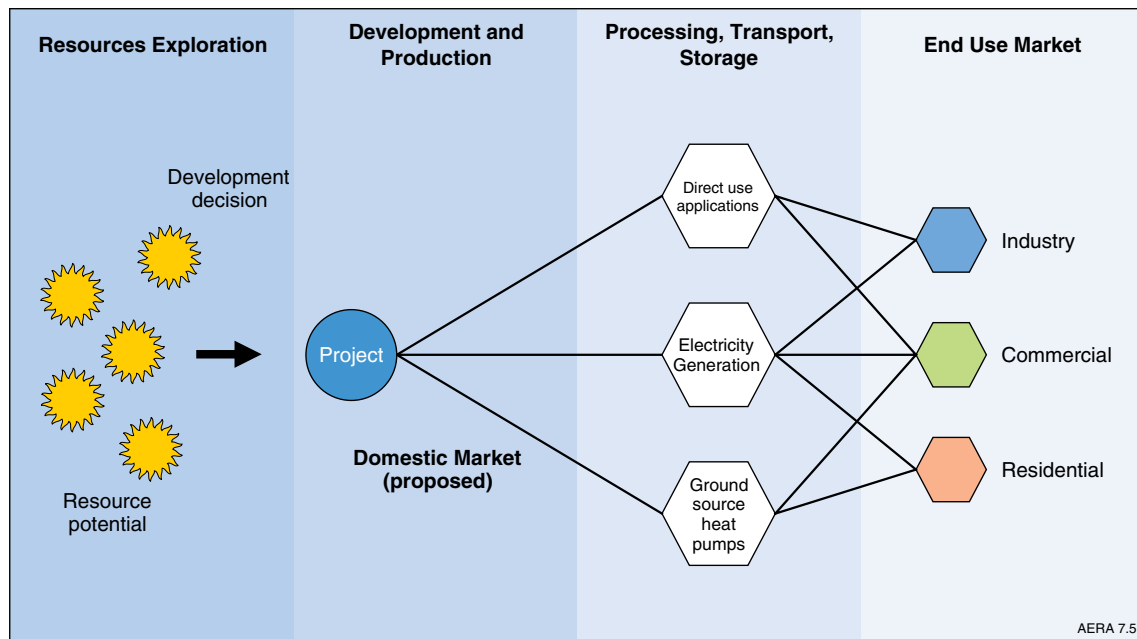


Figure 7.5 Australia's geothermal energy supply chain

Source: ABARE and Geoscience Australia

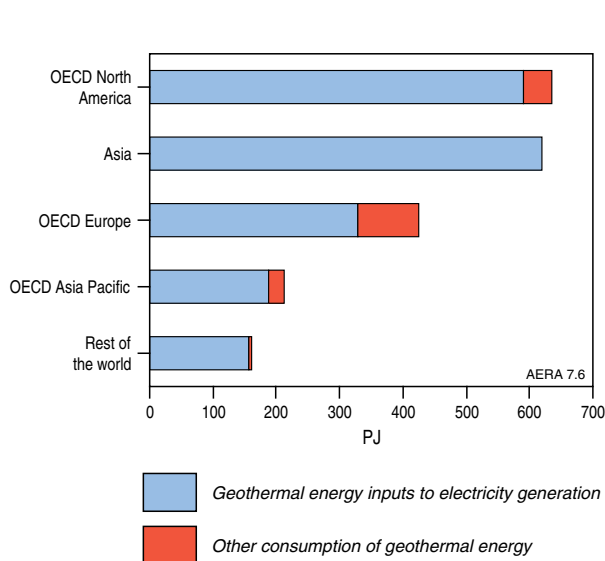


Figure 7.6 Primary consumption of geothermal energy, by region and use, 2007

Source: IEA 2009a

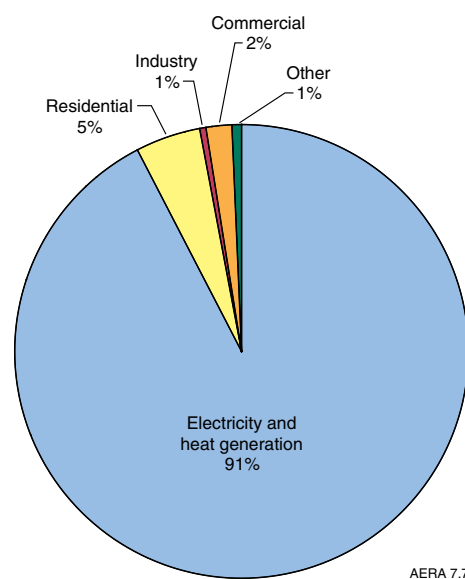


Figure 7.7 World geothermal energy consumption, by sector, 2007

Source: IEA 2009a

energy consumption. Geothermal resources are mainly utilised for electricity generation, although direct-use applications are also significant. Globally, geothermal energy use is projected to more than double over the outlook period to 2030 (IEA 2009b).

### Resources

Until recently, geothermal energy was considered to have significant economic potential only in areas with hydrothermal systems; that is, in countries with active volcanoes. Countries that have identified and are utilising significant amounts of these hydrothermal energy resources include the United States, the Philippines, Indonesia, Mexico, Italy, Iceland, New Zealand and Japan.

Many countries have identified lower temperature geothermal resources and these are increasingly used for district heating and ground source heat pump systems (WEC 2007).

### Consumption

Geothermal energy consumption is equal to geothermal energy production as geothermal energy is not traded in its primary form. Most geothermal plants are built close to the resource because it is generally not efficient to transport high temperature steam or water over distances of more than 10 km by pipeline due to heat losses (or 60 km in thermally insulated pipelines; IGA 2004).

**Table 7.1** Key statistics for the geothermal energy market

	unit	Australia 2006 <sup>b</sup>	OECD 2008	World 2007
<b>Primary energy consumption<sup>a</sup></b>	PJ	-	1316	2053
Share of total	%	-	0.6	0.4
Average annual growth, since 2000	%	-	0.4	0.6
<b>Electricity generation</b>				
Electricity output	TWh	0.0007	40.0	61.8
Share of total	%	-	0.4	0.3
Average annual growth, since 2000	%		2.4	2.5
Electricity capacity	MW	0.08	5364	10 300 <sup>c</sup>

<sup>a</sup> Energy production and primary energy consumption are identical. <sup>b</sup> Goldstein et al. 2008. <sup>c</sup> World data are 2008 Australian Geothermal Energy Group unpublished data

Source: IEA 2009a

### BOX 7.2 STAGES IN DEVELOPMENT OF GEOTHERMAL ENERGY

- Resources and exploration** – usually involves site assessment, leasing and land acquisition, exploratory drilling, and well testing. Notably, exploratory drilling and reservoir assessment, as in oil and gas fields, are high-risk activities and an entire project may be cancelled if an adequate resource is not found (IEA 2003). Improvement in Hot Rock geothermal resource exploration and assessment will reduce costs.
- Development and production** – following successful exploration activity, a company will seek to confirm the energy potential of the resource. The costs associated with drilling and well testing play a major role in determining the economic feasibility of producing energy from geothermal resources. Hot Rock geothermal resources require the creation of a geothermal reservoir by hydrofracturing. Depending on the orientation of stresses in the earth, fractures can be horizontal, vertical, or at an angle. A horizontal fracture network is considered optimal, as it reduces water loss to the surrounding rock and increases the efficiency of the system. The hydrofracturing process can last for several weeks, depending on the degree of fracturing required. Hydrofracturing can induce local seismic activity but the risks associated with this are considered to be very low. Hot Sedimentary Aquifer geothermal resources generally have sufficient naturally-occurring water and permeability that most systems do not need to be enhanced including by hydrofracturing.
- Processing and distribution to end use applications** – once the amount of recoverable heat from the reservoir has been estimated, it needs to be converted to usable energy, either by generating electricity or by direct use of the heat energy in (industrial) processes. Activities that bring a power plant on line include: drilling, project permitting, liquid and steam gathering system, and power plant design and construction (Kagel 2006). Information on geothermal electricity generation technologies is provided in Box 7.1. The type of geothermal resource and its location are important from a commercialisation viewpoint. Access to the electricity grid (whether short or long distance) is important for electricity generation. Location adjacent to infrastructure is important for retro-fitting or development of new direct-use applications.

In 2007, geothermal energy accounted for around 0.4 per cent of world primary energy consumption (table 7.1). World geothermal energy consumption has increased slowly in recent years, at an average rate of 0.6 per cent per year between 2000 and 2007. In the OECD region, geothermal energy accounts for a relatively small share of total primary energy consumption (0.6 per cent in 2008) and growth in recent years has also been very slow (0.4 per cent per year between 2000 and 2008).

Geothermal resources are mainly utilised in the energy markets of OECD North America (31 per cent of world geothermal energy consumption in 2007), Asia (30 per cent), OECD Europe (21 per cent) and the OECD Asia Pacific (10 per cent) (figure 7.6). The main geothermal energy consumers are the United States, the Philippines, Mexico, Indonesia, Italy, Iceland, New Zealand and Japan (IEA 2009a).

Figure 7.7 provides information on the world use of geothermal energy as a fuel input to the transformation (or conversion) sector and a fuel input to other industries in direct-use applications, all measured in PJ. In 2007, 91 per cent of world geothermal energy consumption was used as a fuel input to the transformation sector (of which electricity plants accounted for 97.5 per cent, combined heat and power plants for 2.2 per cent, and heat plants for 0.3 per cent). The remaining 9 per cent was used in direct-use applications (for district heating, agriculture and greenhouses) including, most importantly, 5 per cent in

the residential sector and 2 per cent in the commercial sector (IEA 2009a). Most direct-use applications of geothermal energy occur in the OECD Europe, North America and Asia Pacific regions (figure 7.6).

### Electricity generation

The utilisation of geothermal energy for electricity generation has increased markedly since the 1970s (figure 7.8). World geothermal electricity generation increased from 4.5 TWh in 1971 to 61.8 TWh in 2007, which represents an average annual growth rate of 7.5 per cent. In recent years, however, this growth rate has been much slower, at 2.5 per cent per year between 2000 and 2007. Geothermal energy accounted for 0.3 per cent of world electricity generation in 2007 (IEA 2009a).

Electricity generation from geothermal energy has a low heat-to-electricity conversion efficiency compared with many other sources of electricity generation. For example, in 2007, geothermal inputs of 1884 PJ to electricity generation yielded 61.8 TWh (223 PJ), showing a 12 per cent aggregate conversion efficiency. Regional conversion efficiencies in 2007 ranged from 11.8 per cent to 14.7 per cent for those regions that provided data – the IEA assumes a 10 per cent conversion efficiency for countries that do not supply data. Technological advances in the geothermal energy industry have resulted in efficiency gains which has increased the conversion ratio and decreased the fuel inputs required for a unit of electricity generation.

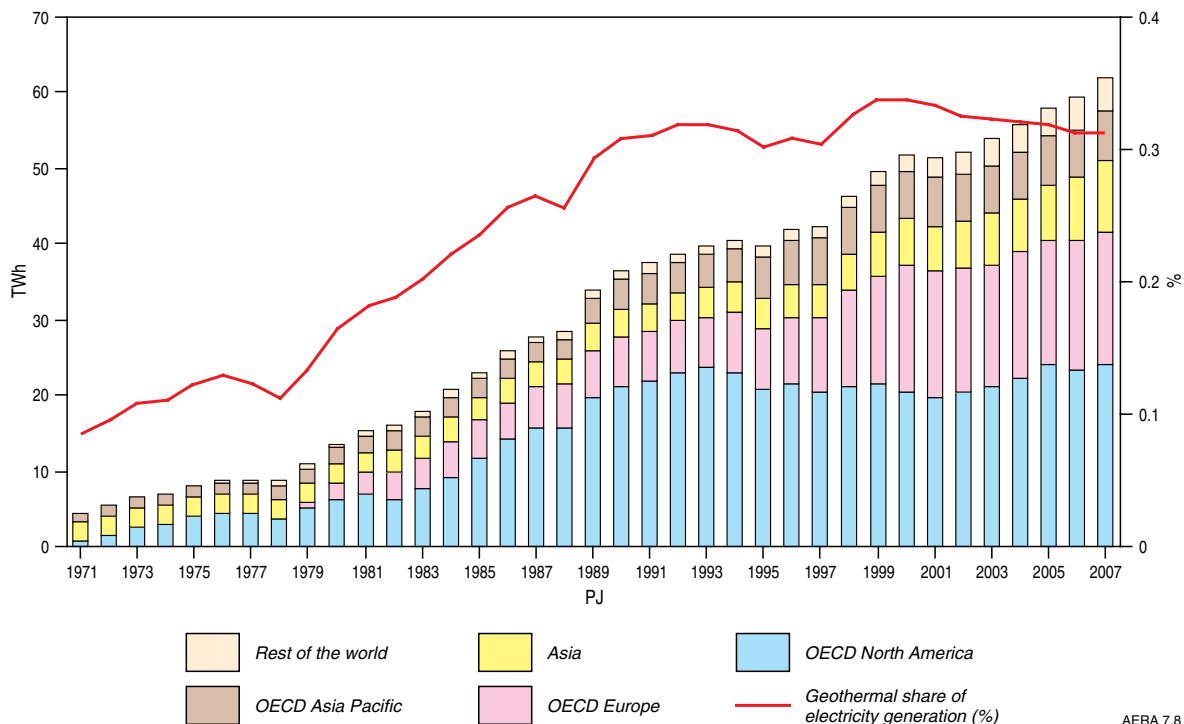


Figure 7.8 World geothermal electricity generation, by region

Source: IEA 2009a

In 2007, 17 countries were generating electricity from geothermal energy (IEA 2009a). The United States was the largest geothermal electricity generator, with output of 17 TWh. Other major producers include the Philippines, Mexico, Indonesia, Italy, Iceland, New Zealand and Japan (figure 7.9a).

Geothermal electricity generation represents a significant share of the total electricity requirements in some countries. In 2007, the three countries most dependent on geothermal energy for electricity generation were Iceland (30 per cent of total electricity generation), El Salvador (24 per cent) and the Philippines (17 per cent) (figure 7.9b).

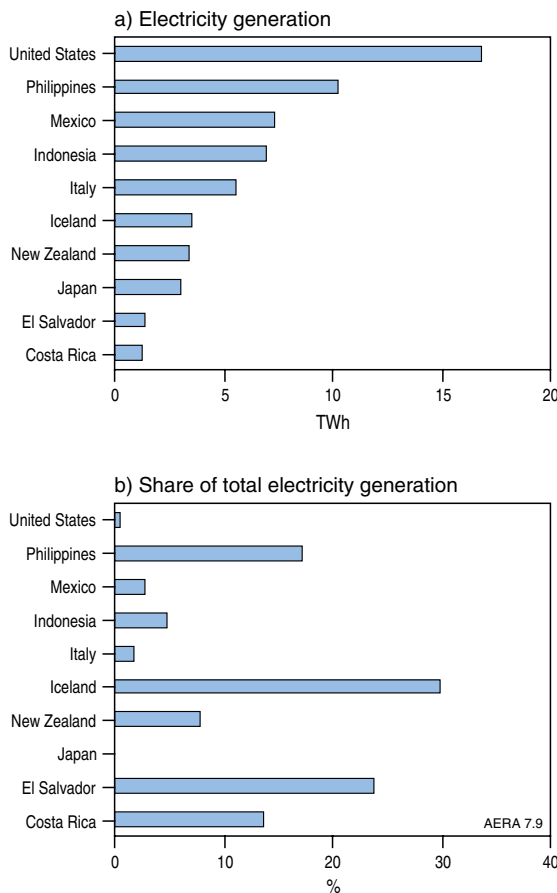
**Direct-use applications**

The largest direct applications of geothermal energy are in ground source heat pumps and industrial applications and space heating: together these accounted for more than 80 per cent of direct-use applications in 2004 (WEC 2007). In 2007, the United States was the largest consumer of direct geothermal energy (43 PJ), followed by Turkey, Iceland and New Zealand (figure 7.10). Ground

source heat pumps are mainly used in areas with noticeable seasonal temperature fluctuations such as North America and Europe.

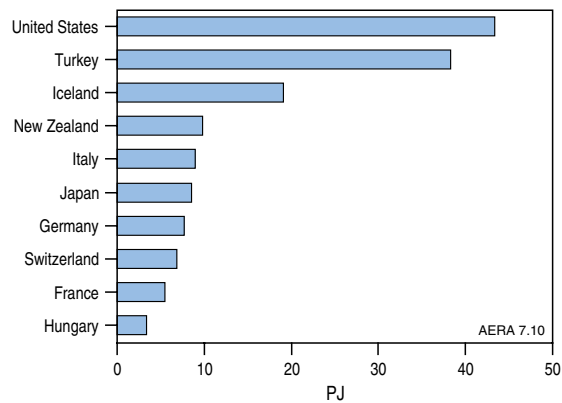
**World market outlook to 2030**

IEA reference case projections for primary consumption of geothermal energy are not available; therefore, the outlook for the world geothermal energy market will focus on electricity generation. However, the increased global demand for renewable energy is expected to increase demand for geothermal energy both for electricity generation and for direct use. The strong growth in use of ground source heat pumps established over the past decade is expected to continue, supported by increased demand for renewable energy and increasing cost-effectiveness of direct-use geothermal energy. Improvements in drilling technologies, improved reservoir management, and reduced operating and maintenance costs, coupled with further exploration, are likely to promote increased utilisation of geothermal resources, and hydrothermal resources in particular.



**Figure 7.9** World geothermal electricity generation, major countries, 2007

Source: IEA 2009a



**Figure 7.10** World direct use of geothermal energy, major countries, 2007

Source: IEA 2009a

**Table 7.2** IEA reference case projections for world geothermal electricity generation

	unit	2007	2030
<b>OECD</b>	TWh	40	92
Share of total	%	0.4	0.7
Average annual growth	%	-	3.7
<b>Non-OECD</b>	TWh	22	81
Share of total	%	0.2	0.4
Average annual growth	%	-	5.8
<b>World</b>	TWh	62	173
Share of total	%	0.3	0.5
Average annual growth	%	-	4.6

Source: IEA 2009b



Geothermal electricity generation is projected to double its share of total electricity generation by 2030 to reach 0.5 per cent. World electricity generation from geothermal energy is projected to nearly triple to 173 TWh by 2030, growing at an average rate of nearly 5 per cent per year (table 7.2). Most of the growth in geothermal electricity generation is expected to come from the United States and non-OECD Asia (IEA 2009b).

## 7.3 Australia's geothermal resources and market

### 7.3.1 Geothermal resources

As there are no active volcanoes on the Australian continent (there are active volcanoes on Heard and McDonald Islands), Australia lacks conventional hydrothermal resources. However, Australia has substantial potential for Hot Rock and Hot Sedimentary Aquifer resources.

The factors which combine to give Australia an excellent Hot Rock geothermal potential are:

- Widespread occurrence of basement rocks, especially granites, with unusually high heat generating capacities because of abundances of the radioactive elements uranium, thorium and potassium which over hundreds of millions of years, decay and produce heat. In particular, granites of Proterozoic age which occur throughout northern and central Australia are generally high heat producing because of unusually high abundances of uranium, potassium and thorium, but some occurrences of older Archean and younger Paleozoic granites are also high heat-producing (Budd 2007). Where these high heat-producing granites are buried beneath thick blankets of thermally insulating sediments or metamorphic rocks, the heat energy is retained in the basement rocks and overlying strata.
- The Australian plate is moving northwards and colliding with the Pacific plate, resulting in a general horizontal stress orientation in the Australian crust, which is favourable for the development during hydrofracturing of sub-horizontal fracture networks that can connect adjacent wells at a similar depth (box 7.2; Hillis and Reynolds 2000). Geodynamics Ltd (2009) estimate that they are able to create an underground heat exchanger at Habanero (in the Cooper Basin of far north-east South Australia) four times larger than has previously been attained elsewhere in the world.

There is also potential for Hot Sedimentary Aquifer geothermal resources in a number of sedimentary basins where circulating groundwater systems may allow a high flow rate of high, moderate and low temperature water. Although commonly at a lower

temperature, the high flow rate allows significant energy delivery to the surface. Water temperatures, permeability and the depth at which useful geothermal waters can be tapped will depend on a number of factors, particularly the nature of the basement rocks underlying the basin and the local hydrology of the basin.

Australia's geothermal potential has only recently been appreciated (box 7.3). As a consequence, there is incomplete knowledge of where geothermal potential exists. It is likely that further data acquisition will lead to increases in the geothermal resource base as already geothermal resources have been identified by company exploration programs in areas outside of those predicted to have geothermal potential in national-scale compilations (figure 7.11).

Current knowledge is based on a database of temperatures recorded at the bottom of more than 5700 deep drill holes, most of which were drilled for petroleum exploration (figure 7.11) supported by more detailed local investigations by companies (box 7.3). National-scale maps published by Geoscience Australia showing the distribution of high heat-producing granites and sedimentary basins, together with other information such as basin depth, provide a national framework and basis for identifying areas likely to have the greatest hot rock potential (Budd 2007).

In addition to the national database, maps and assessments of a number of regional and local assessments have been undertaken. For example, an assessment of the geothermal potential of Victoria (SKM 2005) concluded that while the temperatures of geothermal water found within the top 2000 m of the surface of the state were not sufficiently high for generating electricity, there was abundant and readily accessible geothermal water suitable for direct heating purposes.

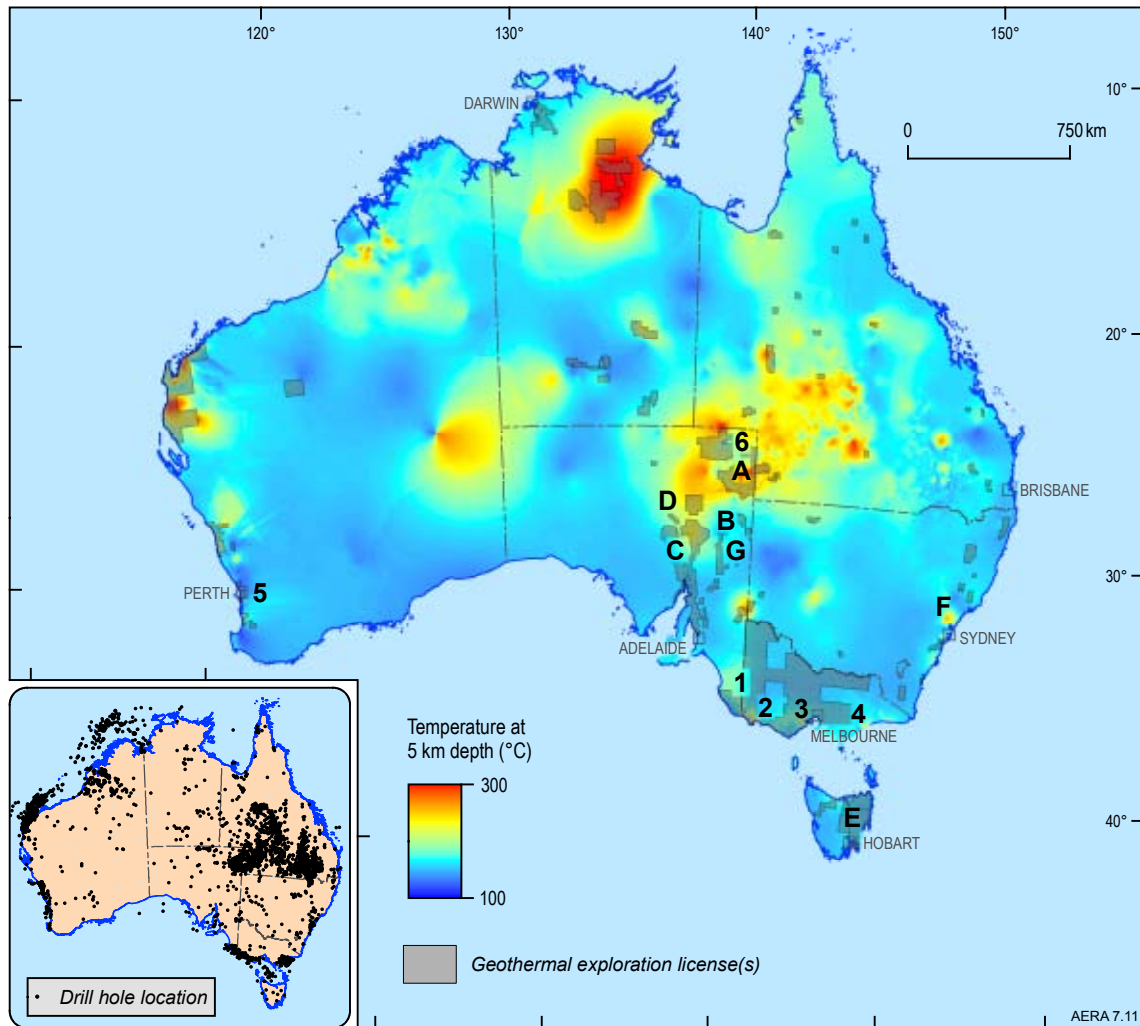
The Australian Code for Reporting of Exploration Results, Geothermal Resources and Geothermal Reserves (2008) has been developed to provide a common framework for categorising geothermal resources and reserves for the information of potential investors (available at [www.agea.org.au](http://www.agea.org.au)). The various categories of the Code describe the development process, which broadly consists of reducing geological uncertainty and completing technical (e.g. energy conversion), economic and regulatory requirements.

**Table 7.3** Australia's reported geothermal resources as at July 2009<sup>a</sup>

	PJ
Identified geothermal resources (sub-economic)	2 572 280

<sup>a</sup> Includes measured, indicated and inferred resources. Australian Code for Reporting of Exploration Results, Geothermal Resources and Geothermal Reserves. [www.agea.org.au](http://www.agea.org.au)

**Source:** Geoscience Australia



**Figure 7.11** Predicted temperature at 5 km depth based mostly on bottom-hole temperature measurements in more than 5000 petroleum and water boreholes. Areas of current exploration discussed in the chapter are shown as overlaid letters (box 7.4) and numbers (box 7.5)

**Note:** Inset map shows the distribution of data points used to construct the map and the paucity of data points over most of the continent

**Source:** Data from Earth Energy Pty Ltd; AUSTHERM database; Geoscience Australia

Eight companies have declared identified geothermal resources in 28 leases across four States totalling 2.6 million PJ of heat in place (table 7.3).

Other than at Birdsville, Australia's reported geothermal resources are currently all sub-economic because the commercial viability of utilising geothermal energy for large-scale electricity generation connected to the National Electricity Market has not yet been demonstrated in Australia. Australia's geothermal industry is still in the RD&D phase of the technology innovation process. It is not expected that any technological breakthroughs are needed. Rather there is a need for progression of projects through all stages from resource definition to production and marketing. Project economics is the main factor that has potential to impede the development of the industry.

Compilations of predicted temperature at 5 km depth (figure 7.11) suggest that there are substantial

areas of the continent where temperatures exceed 200°C at this depth, which is considered feasible for geothermal energy exploitation. This implies that Australia has world class potential for Hot Rock geothermal power.

A simple calculation suggests that if just 1 per cent of Australia's geothermal energy above a minimum temperature of 150°C and at a maximum depth of 5 km were accessible, the total resource is of the order of 190 million PJ, which is roughly 25 000 times Australia's primary energy use (Budd et al. 2008). This calculation ignores the renewable nature of the resource, that it can be utilised at temperatures of less than 150°C, and that improvements in drilling technology will mean that depths of greater than 5 km will be accessible.

The distribution of data points in the small inset map shows that there are extensive areas of the continent with little or no data. New geological data

### BOX 7.3 GEOTHERMAL EXPLORATION ACTIVITY AND DATA ISSUES IN AUSTRALIA

It has only become evident in the last decade that Australia has considerable geothermal potential. This is because of a perception that geothermal resources are found only in regions of active volcanism, which excludes Australia. The Hot Dry Rock concept originated at Fenton Hill, New Mexico, from the work by the Los Alamos Scientific Laboratories in the early 1970s. The concept was to replicate conventional geothermal systems in dry, un-fractured rock by creating the required permeability and introducing the required fluid.

The Australian Bureau of Mineral Resources (BMR) first drew attention to Australia's Hot Rock potential in the Cooper Basin, other sub-basins beneath the Eromanga Basin (Queensland, New South Wales, South Australia); the McArthur Basin (Queensland/Northern Territory); the Otway Basin (Victoria, South Australia); the Carnarvon, Canning and Perth basins (Western Australia); areas in east Queensland; and the Sydney Basin north-west of Newcastle (Somerville et al. 1994). In the Cooper Basin, they reported extrapolated temperatures in excess of 300°C at 5 km depth, and estimated the heat energy available in rocks at temperatures above 195°C at 7.8 million PJ. This work was based largely on a compiled database of temperatures recorded at the bottom of deep drill holes, most of which were drilled for petroleum exploration. This GEOTHERM database has evolved through work at the Australian National University and Earth Energy Pty Ltd to become the AUSTHERM database, maintained and updated by Geoscience Australia. Until recently, this has been the only database of significant use to geothermal explorers, and exploration in Australia was initially limited to areas of petroleum exploration activity because this was the only available relevant dataset.

However, this dataset has a number of inadequacies and does not fully represent Australia's geothermal potential.

More recently, explorers have gained a better understanding of the geology of Hot Rock systems, and have expanded the range of geothermal exploration 'plays' by using a greater range of geoscience information. This, together with the acquisition of new data specifically for geothermal exploration, most notably heat-flow measurements, has increased the exploration search area.

Exploration models being implemented in Australia now cover a range of targeted temperatures from as low as 60°C for direct-use applications, to as high as 250°C. Reservoirs being targeted include granite and metasedimentary rocks requiring fracture enhancement for Hot Rock developments, and deep natural aquifers for Hot Sedimentary Aquifer systems. Most explorers are aiming to achieve suitable temperatures within 4 km depth from surface, but some explorers are considering depths of 5.5 km and greater. These geological systems are being targeted for electricity generation or for direct-use applications, or both via cascading arrangements that enable multiple uses of the same fluid at successively lower temperatures.

Exploration for geothermal resources is rapidly gaining momentum and new geological opportunities are being recognised. The first geothermal exploration licence in Australia was granted in 2000 and by January 2010, 54 companies held 409 leases over an area of 432 000 km<sup>2</sup>. Committed exploration work programs, to be undertaken in every State, amount to more than \$1 billion for the period 2002–2014 (Long et al. 2010).

are needed to provide a better understanding of Australia's geothermal energy potential, particularly near potential major markets.

#### Geothermal exploration

With the great variety of geological systems and end-use applications now being considered, there are not many areas in Australia where geothermal potential has been ruled out.

Figure 7.11 shows areas of active exploration and development. It is important to note that many of the areas under exploration do not appear to be of high temperature on the map: this underscores the fact that bottom hole temperatures used alone are an insufficient geological dataset.

There are numerous explorers in each of the Cooper Basin, the Mount Painter Inlier–Frome Embayment, and the Otway Basin, and many of these companies have announced inferred geothermal resources.

Other areas where resources have been announced include: the Perth Basin (Western Australia); the broad area around Olympic Dam and Lake Torrens, Port Augusta (all South Australia); central Tasmania; the Gippsland Basin, Mildura (Victoria); the area south east of Mount Isa, near Nagoorin (Queensland); and the upper Hunter Valley (New South Wales). Exploration projects listed in boxes 7.4 and 7.5 illustrate the range of geothermal targets.

#### Hot Rock geothermal resources

Exploration has been largely focused on the high temperature Hot Rock geothermal resources of South Australia (Cooper Basin, Adelaide Fold Belt, Mount Painter Inlier–Frome Embayment (box 7.4)). Each of these areas has an underlying basement that includes high heat-producing granites of Proterozoic age. The depth of sedimentary cover varies from relatively shallow along the margins of the Mount Painter Inlier to more than 5 km in the Cooper Basin.

**BOX 7.4 HOT ROCK GEOTHERMAL EXPLORATION AND RESOURCES IN AUSTRALIA**

This box summarises the Hot Rock exploration projects shown on figure 7.11 as letters A to G.

**Area A: Geodynamics Ltd – Cooper Basin area.**

Geodynamics Ltd have shown temperatures in excess of 270°C at 4911 m depth in granite buried beneath approximately 3800 m of sediment. Geodynamics Ltd achieved proof-of-concept of sustained fluid flow between an injector and production well couplet and the surface in March 2009. The company has announced plans for a 25 MW commercial demonstration plant to be operational by December 2013 and this is being supported by a grant of \$90 million through the Australian Government's Renewable Energy Demonstration Program. The estimated thermal resource in the 1962 km<sup>2</sup> of lease area in the Cooper Basin is approximately 400 000 PJ, with an estimated energy resource to support power development of between 5000 and 10 000 MW ([www.geodynamics.com.au](http://www.geodynamics.com.au)).

**Area B: Petratherm Ltd – Paralana project area.**

Petratherm Ltd have partnered with Beach Petroleum and TRUenergy on the Paralana Hot Rock project in the Mount Painter–Frome Embayment area of South Australia. The geological model here is a significant variant on the 'normal' Hot Rock model, and Petratherm intend to create a 'Heat Exchanger Within Insulator' meaning fracturing within the metasedimentary insulating rocks rather than the heat-producing granite. The project received a \$7 million grant through the Australian Government's Geothermal Drilling Program, and completed the Paralana 2 well to a depth of 4 km in November 2009. An independent assessment has estimated a total inferred geothermal resource of 230 000 ± 40 000 PJ. The Project's immediate plan is for a 30 MW commercial demonstration project to provide power to local consumers (particularly uranium mines) and this is being supported by a grant of \$63 million through the Renewable Energy Demonstration Program. Petratherm has a long term development plan to deliver a minimum of 260 MW of base-load power into the National Electricity Market (NEM) Grid from the Paralana site ([www.petratherm.com.au](http://www.petratherm.com.au)).

**Area C: Torrens Energy Ltd – Parachilna project area.**

Torrens Energy Ltd considers that the general area of the Adelaide Fold Belt and the Torrens Hinge Zone has the right components for Hot Rock potential, including high heat flow, good potential for high heat-producing basement including granites, and thick insulating layers. The AUSTHERM map of predicted temperature at 5 km depth (figure 7.11) did not show this area to be hot due to a lack of temperature data.

Torrens Energy received an Australian Government Renewable Energy Development Initiative grant of approximately \$3 million to conduct exploration via heat flow measurements and to build a 3 dimensional

Thermal Field Model. The Treebeard 1A well was drilled to 1807 m and confirmed high heat flow with modelled temperatures in excess of 200°C at 4500 m, and seismic surveying in the area indicates sediment thicknesses of between 3000 to 4500 m. A basement (i.e. granite) hosted reservoir is the primary target and preferred model for geothermal development at Parachilna, and the Company has estimated an Inferred Geothermal Resource of 150 000 PJ within the basement. Torrens Energy plans to drill a 4 km confirmation well at Parachilna. This project is being supported by a \$7 million Geothermal Drilling Program grant.

Torrens Energy entered into a Geothermal Alliance Agreement with AGL Energy Ltd in 2008, which provides for the joint development and commercialisation of base-load geothermal projects close to the NEM grid ([www.torrensenergy.com.au](http://www.torrensenergy.com.au)).

Torrens Energy have also conducted exploration in the immediate vicinity of the Port Augusta power plant where they have demonstrated high heat flow.

**Area D: Green Rock Energy Ltd – Olympic Dam project area.**

Green Rock Energy Ltd have drilled one deep (approximately 2000 m) exploration well, Blanche No. 1, only 10 km away from the BHP Billiton Ltd Olympic Dam Special Mining Lease and 5 km from a 275 kV and 132 kV transmission line connected to the NEM grid. The well provides good information on subsurface temperatures and an indication of the temperature gradient within the Roxby Downs Batholith granite body. The inferred temperature at 5500 m is 190°C. Green Rock have discussed plans for drilling to the east of Blanche 1 where the sediment cover is interpreted to be thicker.

Green Rock have conducted mini-hydrofracturing experiments within Blanche No. 1 and successfully demonstrated the ability to enhance fractures within the granite, and to do so at multiple levels using removable packers. This demonstrated the ability to create sub-horizontal fracture networks including at deeper levels, and is an important step in testing expected reservoir conditions prior to more expensive drill testing.

Green Rock have plans to ultimately develop a 400 MWe power plant with an operation life of at least 30 years ([www.greenrock.com.au](http://www.greenrock.com.au)).

**Area E: KUTH Energy Ltd – Central Tasmania project area.**

The map of predicted temperature at 5 km based on bottom hole temperature data (figure 7.11) suggests Tasmania has only limited geothermal potential. However, several old measurements show high heat flow values. KUTH Energy Ltd have undertaken an extensive drilling program and confirmed areas of anomalously high heat flows. They have also conducted other surveys, including seismic and extensive thermal conductivity measurements, to indicate that there is a considerable thickness



of low-to-moderate thermal conductivity units above what is interpreted to be deeply buried granites. KUTH have announced an Inferred Geothermal Resource of 260 000 PJ at Charlton-Lemont (central Tasmania) ([www.kuthenergy.com](http://www.kuthenergy.com)).

**Area F: Geodynamics Ltd – Hunter Valley project area.** The Somerville et al. (1994) report highlighted an area of high temperature in the upper Hunter Valley area. This was targeted by Australia’s first geothermal company (now Geodynamics Ltd). Although there is little information publicly available about the project, Geodynamics Ltd have reported thermal gradients similar to those found in the Cooper Basin project. Geodynamics Ltd is targeting a high heat-producing Paleozoic granite buried beneath more than 3500 m of Sydney Basin sediments including coal measures ([www.geodynamics.com.au](http://www.geodynamics.com.au)). This project is being

supported by a \$7 million Geothermal Drilling Program grant.

**Area G: Geothermal Resources Ltd – Frome project area.** The Frome project comprises buried Cambrian basins known as the Moorowie and Yalkalpo sub-basins that are underlain by relatively radiogenic Precambrian volcanics and granites rocks of the Curnamona Craton. Frome 12 was drilled to a depth of 1761 m in the centre of a heat anomaly identified from earlier shallow drilling. A bottom of hole temperature of 93.5°C was recorded shortly after drilling ceased. This can be extrapolated to a temperature of 200°C at 4080 m. Geothermal Resources Ltd plan further drilling to intersect granite at about 3 km depth ([www.geothermal-resources.com.au](http://www.geothermal-resources.com.au)).

### Hot Sedimentary Aquifer geothermal resources

There are several sedimentary basins in Australia where high geothermal gradients are known, including the Otway Basin (South Australia, Victoria), Gippsland Basin (Victoria), Perth Basin (Western Australia), Carnarvon Basin (Western Australia) and the Great Artesian Basin (Queensland, New South Wales, South Australia, Northern Territory). These basins have porous and permeable aquifers, which means that hot water circulating naturally at depth within them can be readily extracted. However, some fracture enhancement may be necessary to increase flow rates, especially in deeper parts of basins.

This potential has stimulated significant interest in exploration for Hot Sedimentary Aquifer geothermal resources in a number of basins, notably the Otway, Gippsland and Perth basins (box 7.5). For example, shallow groundwater systems in the Perth Basin are being investigated as a potential source of low temperature energy that could be used for direct heating and other applications. The Otway Basin differs from the other areas in that there is also potential for heat input from dormant volcanic activity that occurred some 5000 years ago. However, previous regional heat-flow data showed no evidence of abnormal heat-flow in the region, including around Mount Gambier – the youngest volcano in the Newer Volcanics group in the south-west Victoria–south-east South Australia region. More detailed heat flow measurements identified a 40 km long zone of elevated heat flow of uncertain origin (including potentially buried granite) along the northern margin of the Otway Basin (Matthews and Beardsmore 2009), and highlighted the need for higher resolution data to identify finer scale variations in heat flow.

### Direct Heat geothermal resources

Direct-use applications generally require access to low to moderate geothermal resources with at

least moderate flow rates. Direct-use applications such as air conditioning for commercial and office buildings via absorption chillers or making fresh water via seawater distillation desalination will generally require access to Hot Sedimentary Aquifer geothermal resources.

Ground source heat pumps have potential in Australia, although this technology is most cost effective in geographic locations that have marked seasonal temperature fluctuations. Estimating the full resource potential is somewhat difficult – this technology can be applied anywhere, but local conditions and the cost competitiveness of the technology are important factors in influencing its uptake.

## 7.3.2 Geothermal energy market

### Electricity generation

To date, two geothermal energy projects have been undertaken in Australia that demonstrated geothermal electricity generation technologies in the Great Artesian Basin (table 7.4).

In 1986, Mulka Station in South Australia used a hot artesian bore to produce a maximum 0.02 MW of power. However, as the project utilised a working fluid on the power plant side that was subsequently banned, it has since ceased operation.

Electricity generation from geothermal energy in Australia is currently limited to one pilot power plant producing 80 kW net at Birdsville in south west

**Table 7.4** Geothermal energy projects in Australia

Project	Company	State	Start up	Capacity
Mulka Station	Mulka Station	SA	1986 (ceased operations)	0.02 MW
Birdsville	Ergon Energy	QLD	1992	0.08 MW

**Source:** Compiled from publically available reports by Geoscience Australia



Queensland. The plant uses a binary-cycle power system, and sources hot (98°C) waters at relatively shallow depths from the Great Artesian Basin. The water comes from the town's water supply bore, which was not drilled specifically as a geothermal bore. Total electricity generation in 2006 was 1.8 MWh, of which 0.5 MWh was provided by the geothermal power plant with the remainder provided by auxiliary LPG and diesel powered generators (Ergon Energy 2009). The plant operator, Ergon Energy, has commenced a feasibility study into whether it can provide Birdsville's entire power requirements and relegate the existing LPG and

diesel-powered generators to be used only as a back-up to meet peaks in electricity demand.

### Direct-use applications

There is a number of small direct-use applications of geothermal energy resources in Australia. At Portland in Victoria, water from a single well was used for heating several council-operated buildings including council offices, library and hospital for several years.

Numerous spas and baths operate in several parts of Australia using warm spring waters. These include spa developments (Mornington Peninsula, Victoria

## BOX 7.5 EXPLORATION FOR HOT SEDIMENTARY AQUIFER RESOURCES IN AUSTRALIA

This box summarises exploration for Hot Sedimentary Aquifer geothermal resources shown as numbers 1–6 on figure 7.11.

In the *Otway Basin*, three companies have projects underway: Panax Geothermal Ltd at the Penola project (1 on figure 7.11), Hot Rocks Ltd at Koroit (2) and Greenerth Energy Ltd at Geelong (3). All projects are Hot Sedimentary Aquifer-style, and have as targets a sequence of sandstone aquifers within early Cretaceous sediments expected to contain water at temperatures in the range 140–180°C at depths of between 2500 to 3500 m. Panax Geothermal Ltd received a \$7 million grant from Round 1 of the Australian Government's Geothermal Drilling Program, and commenced drilling their first deep production well in early 2010. The company has been in discussion with owners of nearby petroleum companies regarding the use of existing otherwise unused wells as an injection well. Panax Geothermal Ltd has a development plan to build a 59 MW (net) generator within a project timeframe of 24 months once proof-of-concept is complete ([www.panaxgeothermal.com.au](http://www.panaxgeothermal.com.au)). Hot Rocks Ltd has been awarded a \$7 million Geothermal Drilling Program grant for the Koroit proof of concept project ([www.hotrockltd.com](http://www.hotrockltd.com)). The Greenerth Energy Ltd project at Geelong has also been awarded a \$7 million Geothermal Drilling Program grant, and also a \$25 million Victorian Government Energy Technology Innovation Strategy grant.

In the *Gippsland Basin*, Greenerth Energy Ltd have a project in the LaTrobe Valley, and a principal aim of this Hot Sedimentary Aquifer and direct-use project is to assist in decreasing the carbon intensity of this brown-coal region ([www.greenerthenergy.com.au](http://www.greenerthenergy.com.au)) (4 on figure 7.11). The target aquifer is the Rintouls Creek Formation where temperatures greater than 150°C are expected between 3250–4000 m depth.

The *Perth Basin* (5 in figure 7.11) is a 1000 km long geological rift containing sediments up to 15 km thick. It contains thick sequences of permeable aquifers containing hot geothermal water with

sufficient temperature and water flow capacity at depths considered to be economic for electricity generation. Green Rock Energy Ltd, in conjunction with the University of Western Australia, is preparing for the development of Australia's first commercial geothermal powered heating and air-conditioning unit, in a commercial building in the Perth Metropolitan area. The geothermal energy will be the direct heat source which will replace conventional air-conditioners and their associated large scale electrical and natural gas consumption. The company was working towards the drilling of the geothermal wells in late 2009 with the commissioning of the commercial unit in 2011. By replacing a Conventional Chiller that uses electric energy with an Absorption Chiller using geothermal energy, large commercial buildings, including universities, hospitals, hotels, airports, data centres and shopping centres, can be air-conditioned using hot geothermal water as the principal power source. The project will need to drill two wells to approximately 2500 m depth to extract water at temperatures greater than 75°C. This project is being supported by a \$7 million Geothermal Drilling Program grant ([www.greenrock.com.au](http://www.greenrock.com.au)).

The *Great Artesian Basin (GAB)* is the largest artesian basin in the world covering about 22 per cent of the Australian continent and has ground waters of 30–100°C at the well head. Australia's only operating geothermal power plant at Birdsville uses water at 98°C drawn from the GAB. The temperature of the water varies across the Basin, and is understood to be hottest in northeastern South Australia (6 on figure 7.11). Several companies have exploration leases in this area. The maximum water temperature is thought to be less than 140°C, which is at the lower limit for generating electricity at a large commercial scale. The added cost of transmission infrastructure is likely to make electricity generation for supply into the NEM uneconomic in the near future, however local supply is likely to be competitive against power generated by diesel or gas generators (as is the case at Birdsville).

and Mataranka, Northern Territory), artesian baths (Moree, Lightning Ridge artesian baths, and Pilliga Hot Artesian bore, inland New South Wales) and swimming pool heating (Challenge Stadium, Western Australia). Ground source heat pumps are used in several public buildings, including the Geoscience Australia building in Canberra.

## 7.4 Outlook to 2030 for Australia's geothermal resources and market

Australia's considerable high-temperature (above 180°C) geothermal energy potential associated with deep Hot Rock resources and lower temperature resources associated with hot waters circulating in aquifers in sedimentary basins (Hot Sedimentary Aquifer resources), have potential for electricity production and direct use. The requirements for development of geothermal electricity generation include significant investment, firstly in demonstration projects to prove viable generation, and then in commercialisation. Government policy and direct support for research, development and demonstration are likely to continue to play a significant role in this process until commercial viability can be established.

Geothermal power has significant benefits. It is environmentally benign, renewable (temperature is renewed by conduction from adjacent hot rocks, and heat is generated by natural radiogenic decay), and able to provide base-load power and heat for industrial processes. Ground source heat pumps have been proven to be viable in various parts of Australia, and widespread implementation could provide a significant energy efficiency and carbon reduction benefit.

### 7.4.1 Key factors influencing the future development of Australia's geothermal energy resources

Australia's existing indicated geothermal resources are sufficient to meet projected domestic demand over the period to 2030. There is also scope for Australia's geothermal resources to expand substantially, based on further predicted temperature at 5 km data, heat flow measurements and enhanced general geological knowledge. This in turn could affect the market outlook as several expected proof-of-concept projects demonstrate the suitability of the technology to Australia and commercial demonstration projects are established. However, some of Australia's geothermal resources lie remote from the existing electricity transmission grid.

#### BOX 7.6 AUSTRALIAN GEOTHERMAL INDUSTRY DEVELOPMENT FRAMEWORK

The Australian Geothermal Industry Development Framework and the associated Australian Geothermal Industry Technology Roadmap were released in December 2008 (see Australian Government Department of Resources, Energy and Tourism 2008a, b). The framework recognised that Australia's geothermal industry is at a very early stage of development and identified major challenges for the future of the industry including the development of:

- an attractive investment environment in which early stage ventures are able to mature to a level sufficient to attract private finance;
- accurate and reliable information on geothermal energy resources in Australia;
- networks that encourage sharing of information and experience between stakeholders including companies, researchers and governments in Australia and overseas;
- geothermal technologies suited to Australian conditions;
- a skilled geothermal workforce;
- community understanding and support of the economic, environmental and social benefits of geothermal energy;
- a geothermal sector which understands and can contribute to the institutional environment within

which it operates; and

- a consistent, effective and efficient regulatory framework for geothermal energy.

Several recommendations have been significantly advanced already. For example, three key outcomes are:

- The first edition of the *Australian Code for Reporting of Exploration Results, Geothermal Resources and Geothermal Reserves*.
- The Australian Government's \$435 million Renewable Energy Demonstration Program in November 2009 awarded \$90 million to Geodynamics Ltd's Cooper Basin Commercial Demonstration Program, and \$63 million to Petrathem Ltd's Paralana project.
- The Australian Government's \$50 million Geothermal Drilling Program, administered by the Department of Resources, Energy and Tourism, has provided seven grants of each of \$7 million for proof-of-concept projects in Hot Rock and Hot Sedimentary Aquifer settings for both electricity generation and direct-use applications.
- In addition, the Victorian Energy Technology Incentive Scheme has awarded \$25 million to a geothermal project out of a total of \$72 million of grants.

### Government support for geothermal energy research, development and demonstration (RD&D)

Government policies relating to geothermal energy research, development and demonstration (RD&D) are critical to the outlook for electricity generation from geothermal energy in Australia. Actions to accelerate the development of the geothermal industry include completion of the Australian Geothermal Industry Development Framework and the associated Australian Geothermal Industry Technology Roadmap (box 7.6). Direct assistance includes the Australian Government's \$50 million Geothermal Drilling Program, administered by the Department of Resources, Energy and Tourism, which has provided grants of \$7 million for seven proof-of-concept projects in Hot Rock and Hot Sedimentary Aquifer settings. The Australian Government has also provided funding to assist two geothermal projects to a total of \$153 million to progress from proof-of-concept to commercial demonstration stage from its \$435 million Renewable Energy Demonstration Program. These programs, which provide funding to projects on a merit-basis, will accelerate the development of the geothermal industry by helping to address the key impediment to development of insufficient market investment. It is expected that the funding will not only assist companies to finance their respective stages of activity in the projects and reduce financial risk to investors but have the longer term effect of lowering the technical risk of both stages of geothermal developments, and therefore increasing investor confidence.

### Better definition of geothermal resources – improved basic geoscientific data to enhance development prospects for geothermal energy

The AUSTHERM database of bottom hole temperatures is largely populated by petroleum drilling results. Of necessity, this dataset is biased towards particular geological settings, i.e. basins. Geothermal resources are not limited to the same geological settings as petroleum resources. Not only is the geographical distribution of this data uneven and inadequate, measurements of bottom hole temperatures are not robust for predicting temperature at depth.

Heat flow measurements are normally significantly more robust indicators of temperature at depth. However, in addition to the gradient and conductivity data necessary, other geological data, including lithologies at depth are very important to make confident temperature extrapolations. Both the number and distribution of publicly-available heat flow measurements, and the knowledge of geology at depth, are inadequate for efficient geothermal exploration in Australia.

Given the potential for geothermal to be a significant energy source in the future, there is support for government programs to increase the collection and dissemination of basic pre-competitive geoscientific data to guide future geothermal exploration (see, for example, Hogan 2003). Government investment in a geothermal resources database will also complement private sector activity in the geothermal industry and enhance prospects for future geothermal energy development in Australia. The priorities are summarised in Box 7.7.

### Geothermal RD&D and technology development

Further research in the exploration and enhancement of reservoirs and in drilling and power generation technology, particularly for the exploitation of low temperature geothermal resources, will be important in realising potential in this area (IEA 2008; box 7.3). Technology developments in oil and gas production and carbon storage, such as horizontal wells, expandable solid tube technology, rock fracturing and improved seismic technology, will also benefit geothermal electricity generation (IEA 2006).

It is important to note that the development of the geothermal industry in Australia is not dependent on major technology breakthroughs – all of the required technology exists from the conventional geothermal and petroleum industries, and to a large degree it is a matter of a trial-and-error learning process in adapting this technology. The challenges in Australian geothermal systems are more about making exploitation more economically viable (for example through cheaper drilling), requiring incremental technological adaptation and development rather than major technological breakthroughs.

As many other countries around the world (especially the United States) have very large untapped Hot Rock geothermal resources there is a technology development push worldwide. Geothermal resources in Hot Sedimentary Aquifer systems are also being brought into production in a number of countries, providing another source of experience and technology developments internationally.

Ground source heat pumps have already been demonstrated to be economically and environmentally beneficial in numerous installations in Australia.

As a consequence of the geothermal industry being new to Australia, only limited research has been conducted to date but this is now developing quickly and it is expected that Australian research capability will continue to grow. Several research centres have been established, including:

- The University of Queensland has a \$15 million program mostly investigating power conversion technologies;

## BOX 7.7 IMPROVING KNOWLEDGE OF AUSTRALIA'S GEOTHERMAL POTENTIAL

Because of the inadequate geoscience data available to the industry in Australia, exploration has only been undertaken in those areas having useful data. A good understanding of geology is a prerequisite for developing geothermal resources and the knowledge required is scale-dependent.

In selecting tenement areas for more detailed exploration for geothermal resources in Australia companies rely on publicly available, pre-competitive regional scale geological data, as companies only have the right to collect information on ground that they have under lease. Once a company has taken out a lease area, it then explores in increasing detail for the small volume of rock that will produce the most profitable geothermal resource.

Publicly available geoscience data that is sought for evaluation by the geothermal exploration companies comes from:

- seismic reflection, gravity, magnetic and magnetotelluric surveys;
- stratigraphic drilling in key locations and thermal conductivity measurements for key stratigraphic units throughout the country;
- accurate depth to conductive basement maps based on the activities above;
- downhole temperature measurements;
- granite geochemistry, particularly of buried units; and
- assessments of risks posed by geothermal

developments (including radiation/radon, induced seismicity).

Many of these data types are already being collected to varying degrees by Geoscience Australia and State geological surveys, but this has not been done in a systematic manner with geothermal energy in mind. Some database development is required to incorporate new data types (such as thermal conductivity) and to make existing data more accessible. Also data generated by companies and reported as part of lease requirements needs to be captured and made available.

Companies conduct more detailed studies in their exploration leases, such as:

- in-situ porosity and permeability measurements or their proxies;
- detailed measurements of crustal stress distribution, including down-hole stress measurements;
- enhanced seismic monitoring, including temporary deployment of detailed monitors during hydrofracturing;
- fluid chemistry and rock mineralogy to predict the effects of scaling (mineral deposition that may inhibit fluid flow either in the rock fracture network or in the piping or power plant); and
- fluid chemistry for use as a geothermometer in exploration, and for studies of fluid-rock interaction to predict and develop mitigation strategies for scaling and corrosion during production.

- The Western Australian Geothermal Centre of Excellence has \$2.3 million to investigate direct-use applications of geothermal energy including absorption chillers;
- The University of Adelaide is receiving a smaller amount of funding mostly for research into exploration and fracturing techniques; and
- The University of Newcastle has a small program researching power cycle technology.

The demonstration of the economic viability of the extraction and use of geothermal energy in the domestic Australian energy market is required for the future development of the industry. Several pilot projects are expected to be advanced within the next few years.

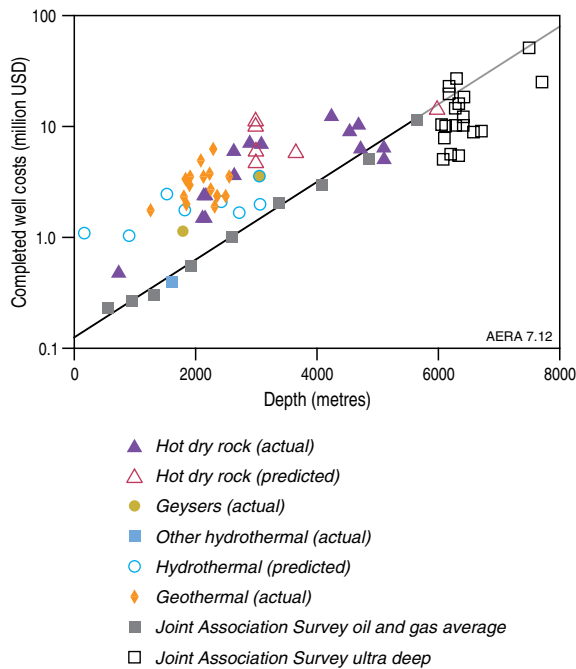
### **The cost of geothermal energy is expected to continue to fall over the outlook period**

The costs of hydrothermal energy have dropped substantially since the 1970s and 1980s – overall, costs fell by almost 50 per cent from the mid

1980s to 2000. Upfront costs, comprising mainly of exploration, well-drilling and plant construction, can comprise up to 70–80 per cent of the overall costs of geothermal electricity, depending on the technology. For example, drilling costs can account for as much as one third to one half of the total cost of a geothermal project (IEA 2008). Operation and maintenance costs account for a very small percentage of total costs, but can vary depending upon the location of the plant. Geothermal drilling costs tend to rise exponentially with drilling depth (figure 7.12). Company reports indicate that the cost of drilling to a well depth of 5 km in Australia is in the order of \$10–15 million.

Hot Rock geothermal energy has only been deployed commercially in one location (Landau, Germany, a hybrid project that uses hydrofracturing) but is being tested and developed at a number of locations. Like conventional geothermal power systems, Hot Rock geothermal systems have high up front costs, up to 70–80 per cent of total costs, in developing the well





**Figure 7.12** Completed well costs as a function of depth  
**Source:** Augustine, Tester and Anderson 2006

field at the geothermal resource. Hot Sedimentary Aquifer geothermal technology is considered to be of lower risk and cheaper than Hot Rock technology because it generally involves shallower drilling and generally does not require reservoir stimulation through hydrofracturing. However, high flow rates are required.

The cost of electricity produced from geothermal energy sources, both Hot Sedimentary Aquifer and Hot Rock, are expected to fall over the next 10–20 years as the technologies mature. A considerable advantage that geothermal electricity generation has over other renewable energy generators is that it is base load with high capacity and availability factors (each greater than 90 per cent). It will classify as a ‘scheduled generator’ under the Australian Electricity Market rules in the eastern half of Australia.

### Cost of access to the grid

A potential impediment to the development of some of Australia’s geothermal resources for geothermal electricity generation is the distance of some of the resources from existing transmission lines or consumption centres. Most geothermal plants are built at the site of the reservoir since it is not practical to transport geothermal resources over long distances. High-voltage direct current transmission lines are used because for a given carrying power capacity they have less line loss (MIT 2006).

Additional power lines must be built if transmission infrastructure does not exist where a geothermal resource is located. Some of Australia’s known geothermal resources are located in areas remote

from the existing electricity transmission grid. Geothermal developers pay the direct costs to connect their plant to the grid, and may incur additional transmission related costs, including the construction of new lines, upgrades to existing lines, or new transformers and substations (Kagel 2006).

This impediment may be lessened by the proposed changes to the National Electricity Market rules by the Australian Energy Market Commission (AEMC) that include the introduction of a new framework for the connection of generation clusters in the same location over a period of time. The recommended model overcomes the lack of commercial incentives for network businesses to bear the risk of building assets to an efficient scale (AEMC 2009). This is called Scale Efficient Network Extension (SENE) and will assist geothermal (and other renewable energy) projects to overcome the relatively high cost of accessing the electricity grid. The geothermal industry is investigating the cost impacts of transmission connection to the National Electricity Market. One study focussing on connection from the Cooper Basin to Port Augusta via the Arrowie Basin suggests benefits to both generators and customers if the transmission network is built to coincide with the onset of geothermal production (MMA 2009).

There is scope for some industries to co-locate to new geothermal generators. For example, Geodynamics Ltd has been investigating the establishment of a large data centre at Innamincka in the Cooper Basin. In this case it is cheaper to lay fibre optic cable than power lines to the major centres.

### Environmental considerations

Geothermal energy is generally regarded as one of the most environmentally-benign sources of electricity generation.

- **Air emissions** – geothermal fields in Australia will generally utilise groundwater systems, and will have very few air emissions especially if using a double closed loop system. Some concerns have been raised over radon release; however these are projected to be well within Australian occupational health and safety guidelines (PIRSA 2009). The only emissions created are in building infrastructure (well completion, plant, power lines) which is necessary for all generation technologies. There are no emissions associated with the ‘fuel’. Some volcanic systems used in other parts of the world emit CO<sub>2</sub> as a natural part of magma outgassing: this is a natural process that happens whether used for geothermal power production or not; and Australia has no such active volcanism.
- **Noise pollution** – geothermal plants produce noise during the exploration drilling and construction phases. With direct-heat applications, noise is usually negligible during



operation. Noise from normal operation of power plants generally comes from the cooling tower fans, steam ejector and turbine.

- **Water usage** – geothermal systems in Australia are generally expected to be operated as closed-loop systems for a number of reasons, including water conservation. For **Hot Rock** developments, the loss of water injected into the artificial reservoir would result in operational inefficiencies through higher pumping costs and lower energy returns than optimal and are therefore to be avoided. In **Hot Sedimentary Aquifer** systems, water needs to be returned to the originating aquifer otherwise the reservoir pressure will be depleted and water returns will be reduced. In Hot Rock systems requiring hydrofracturing to enhance the reservoir permeability, water will need to be introduced from the surface during the fracturing process. This is in the order of tens of megalitres to create a reservoir volume of up to 10 cubic kilometres. As it is a one-off use, this water will generally continue to serve as the circulation fluid during production. As they will generally be working in areas of very low rainfall, Australian geothermal developers are mostly planning to use air-cooled power stations. Some research is being conducted into using ground-loop cooling or novel air-cooled systems to assist power plant efficiency during peak daytime temperatures, and also to using solar energy to boost input water temperatures to increase power plant efficiencies. Other generators of power may also benefit from this technology.
- **Subsidence** – this was found to be a problem during some early conventional geothermal developments overseas. ReInjection of groundwaters became a common practice to prevent this. Geothermal reservoirs in Australia are considerably deeper than conventional reservoirs overseas, and this combined with reinjection mean that subsidence is most unlikely to be of concern.
- **Induced seismicity** – this term is used to describe earth movements generated by human activities. Induced earth movements are associated with the movement of material into

or out of the earth, for example during water reservoir filling, underground mining, oil and gas extraction, compressed carbon dioxide injection, and development of Hot Rock reservoirs. The hydrofracturing process employed in the creation of Hot Rock reservoirs can induce seismic activity, which can be detected by sensitive seismological instruments (Lewis 2008). In over thirty years of hydrofracturing in Hot Rock developments overseas and more recently in Australia, there have been no instances of damage caused by earthquakes directly attributed to hydrofracturing. Substantial knowledge is being gained about controlling the incidence of microfracturing by varying the rates and pressures of fluid injection. Ultimately this will lead to better reservoir development with minimal risk from unwanted seismicity. Earthquakes are commonly reported using a ‘Magnitude’ scale, and this describes the intensity of the earthquake at its origin: it does not provide information on the effects at surface, which can be many kilometres above and away from the point of origin. Ground motion sensors provide information about the extent of movement at a point on the surface and are a significantly better way of monitoring the surface effects of induced seismicity.

#### 7.4.2 Outlook for geothermal energy market

The major geothermal energy developments occurring in Australia are focused on electricity generation. Several companies have plans for pilot and demonstration plants, and some for commercial generation. Given the major investment in geothermal energy RD&D by both government and industry in Australia, it is considered likely that geothermal power will be produced on a commercial scale over the period to 2030.

There is considerable uncertainty surrounding projections of geothermal energy in the period to 2030. The commercial development of the industry is dependent on the demonstration in Australia of commercial viability to show an acceptable investment risk, and this includes grid connection issues. No technology breakthroughs are needed,

**Table 7.5** Geothermal projects under development, as of October 2009

Project	Company	Location	Status	Start up	Capacity	Capital Expenditure
Moomba stage 2	Geodynamics Ltd	Moomba, SA	Demonstration plant under construction	2013	25 MW	na
Paralana	Petratherm Pty Ltd	Mount Painter, SA	First well completed, feasibility underway	na	30 MW	\$200 m
Penola	Panax Geothermal Ltd	Limestone Coast, SA	Commenced first well	na	59 MW	\$340 m

Source: ABARE 2009; Geodynamics Ltd 2009, Panax Geothermal Ltd 2009

but advances in technologies that reduce costs will potentially lead to greater market penetration by geothermal energy.

In the latest ABARE long-term energy projections which incorporate the Renewable Energy Target, a 5 per cent emissions reduction target and other government policies, geothermal electricity generation is projected to increase to annual production of around 6 TWh in 2029–30 (ABARE 2010). This represents around 1.5 per cent of Australia's projected electricity generation in that year. Geothermal energy is projected to be the fastest growing source of electricity to 2030, albeit from a near zero base. Electricity is projected to be supplied initially by demonstration plants but commercial scale plants are expected to be in operation by 2030.

### Proposed development projects

The Geodynamics Ltd project in the Cooper Basin in South Australia is the most advanced Hot Rock geothermal project in Australia. Geodynamics Ltd completed proof-of-concept at their Habanero prospect in early 2009. It has also started drilling two other prospects (Savina and Jolokia). Geodynamics Ltd's tenements in the Cooper Basin have been shown to contain more than 400 000 PJ of high-grade thermal energy.

Geodynamics Ltd have begun development of a 25 MW Commercial Demonstration Project for completion by 2013 (table 7.5). In November 2009 Geodynamics Ltd was awarded a \$90 million Renewable Energy Demonstration Program grant to assist the commercial demonstration project.

Petratherm Ltd have completed drilling well Paralana 2 at their Paralana Hot Rock Heat Exchanger Within Insulator project. Together with Joint Venture partners Beach Petroleum and TRUenergy, the project aims to build a 7.5 MW pilot plant to supply power to nearby uranium mines and to then scale up to a 30 MW demonstration plant connected to the NEM grid (table 7.5). In April 2009 Petratherm Ltd was awarded a \$7 million Geothermal Drilling Program grant, and in November 2009 was awarded a \$62.75 million Renewable Energy Demonstration Program grant to assist development of their demonstration project.

Panax Geothermal Ltd started drilling the Salamander 1 well at the Penola Hot Sedimentary Aquifer project having received a \$7 million grant from Round 1 of the Geothermal Drilling Program. Panax Geothermal Ltd has announced plans for the rapid development of a 59 MW (net) commercial plant at their Penola project in the Limestone Coast area of South Australia (Panax Geothermal Ltd 2009).

## 7.5 References

ABARE (Australian Bureau of Agricultural and Resource Economics), 2009, Electricity generation: major development projects – October 2009 listing, Canberra, November

ABARE, 2010, Australian energy projections to 2029–30, ABARE research report 10.02, prepared for the Department of Resources, Energy and Tourism, Canberra

AEMC (Australian Energy Market Commission), 2009, Review of Energy Market Frameworks in light of Climate Change Policies: Final Report, September, Sydney

Australian Government Department of Resources, Energy and Tourism (RET), 2008a, Australian Geothermal Industry Development Framework, Canberra, December, <<http://www.ret.gov.au>>

Australian Government Department of Resources, Energy and Tourism (RET), 2008b, Australian Geothermal Industry Technology Roadmap, Canberra, December, <<http://www.ret.gov.au>>

Ayling BF, Budd AR, Holgate FL and Gerner E, 2007a, Electricity Generation from Geothermal Energy in Australia, Geoscience Australia Fact Sheet, GEOCAT # 65455, Canberra, <[http://www.ga.gov.au/image\\_cache/GA10663.pdf](http://www.ga.gov.au/image_cache/GA10663.pdf)>

Ayling BF, Budd AR, Holgate FL and Gerner E, 2007b, Direct-use of Geothermal Energy: Opportunities for Australia, Geoscience Australia Fact Sheet, GEOCAT # 65454, Canberra, <[http://www.ga.gov.au/image\\_cache/GA10660.pdf](http://www.ga.gov.au/image_cache/GA10660.pdf)>

Augustine C, Tester JW, and Anderson B, 2006, A Comparison of Geothermal with Oil and Gas Well Drilling Costs, Proceedings of the 31st Workshop on Geothermal Reservoir Engineering, Stanford University, California, 30 January to 1 February, <<http://pangea.stanford.edu/ERE/pdf/IGAstandard/SGW/2006/augustin.pdf>>

Budd AR, 2007, Australian radiogenic granite and sedimentary basin geothermal hot rock potential map (preliminary edition), 1:5 000 000 scale, Geoscience Australia, Canberra

Budd AR, Holgate FL, Gerner E, Ayling BF and Barnicoat A, 2008, Pre-competitive Geoscience for Geothermal Exploration and Development in Australia: Geoscience Australia's Onshore Energy Security Program and the Geothermal Energy Project. In Gurgenci H and Budd AR (eds), Proceedings of the Sir Mark Oliphant International Frontiers of Science Australia Geothermal Energy Conference, Record 2008/18, Geoscience Australia, Canberra, p1–8, <[http://www.ga.gov.au/image\\_cache/GA11825.pdf](http://www.ga.gov.au/image_cache/GA11825.pdf)>

Energy and Geoscience Institute, 2001, Geothermal Energy: Clean Sustainable Energy for the Benefit of Humanity and the Environment, University of Utah, May, <<http://www.geothermal.org>>

Ergon Energy, 2009, Birdsville organic Rankin Cycle geothermal power station, factsheet, <[http://www.ergon.com.au/Resources/Birdsville\\_GeoThermal\\_ORC.pdf](http://www.ergon.com.au/Resources/Birdsville_GeoThermal_ORC.pdf)>

Geodynamics Ltd, 2009, Presentation at Australian Geothermal Energy Conference, Brisbane, 11–13 November

Geothermal Resources Council, 2009, What is geothermal?, <<http://www.geothermal.org>>

Goldstein BA, Hill AJ, Budd AR and Malavazos M, 2008, Status of Geothermal Exploration and Research in Australia, Geothermal Resources Council Transactions, Vol. 32, 79–86

Hillis RR, and Reynolds SD, 2000, The Australian stress map. *Journal of the Geological Society*, 157, 915–921

Hogan L, 2003, Public Geological Surveys in Australia, ABARE eReport 03.15, Prepared for the Department of Industry, Tourism and Resources, Canberra, August

IEA (International Energy Agency), 2003, Renewables for Power Generation: Status & Prospects, OECD/IEA, Paris

- IEA, 2006, Energy Technology Perspectives 2006: Scenarios & Strategies to 2050, OECD/IEA, Paris
- IEA, 2008, Energy Technology Perspectives 2008: Scenarios & Strategies to 2050, OECD/IEA, Paris
- IEA, 2009a, World Energy Balances 2009, Paris
- IEA, 2009b, World Energy Outlook 2009, OECD/IEA, Paris
- IGA (International Geothermal Association), 2004, What is Geothermal Energy?, Italy, <<http://iga.igg.cnr.it/documenti/geo/Geothermal%20Energy.en.pdf>>
- Kagel A, 2006, A Handbook on the Externalities, Employment, and Economics of Geothermal Energy, Geothermal Energy Association, Washington, DC
- Lewis B, 2008, Induced Seismicity and Geothermal Power Development in Australia, Geoscience Australia Fact Sheet, GEOCAT # 66220, Canberra, <[http://www.ga.gov.au/image\\_cache/GA11478.pdf](http://www.ga.gov.au/image_cache/GA11478.pdf)>
- Lindal B, 1973, Industrial and other applications of geothermal energy, Geothermal Energy: Review of Research and Development, Paris, UNESCO, LC No. 72-97138, 135–148
- Long A, Goldstein B, Hill T, Bendall B, Malavazos M and Budd A, 2010. Australian geothermal energy advances. Presentation at Thirty-Fifth Workshop on Geothermal Reservoir Engineering, Stanford University, Stanford, California, United States, February, 2010
- Matthews C and Beardsmore G, 2009, New heat flow data from south-east Australia. Exploration Geophysics, 38, 260–269
- MIT (Massachusetts Institute of Technology), 2006, The Future of Geothermal Energy – Impact of Enhanced Geothermal Systems (EGS) on the United States in the 21st Century, Idaho Falls, <[http://geothermal.inel.gov/publications/future\\_of\\_geothermal\\_energy.pdf](http://geothermal.inel.gov/publications/future_of_geothermal_energy.pdf)>
- MMA (McLennan Magasanik Associates), 2009, Preliminary Assessment of the Value of a New 275 kV Transmission line to connect Geothermal Resources to the NEM in South Australia, Victoria, <<http://www.agea.org.au/information/publications/>>
- Panax Geothermal Ltd, 2009, Penola Project – Limestone Coast, South Australia 59 MW “Stand Alone” Case, Project Evaluation, <<http://www.panaxgeothermal.com.au/Images/File/20090910%20PANAX%20SCALE%20UP%20CASE%20WEBSITE%20VERSION.pdf>>
- PIRSA (Primary Industries and Resources – South Australia), 2009, Radon and Naturally Occurring Radioactive Materials (NORM) associated with Hot Rock Geothermal Systems, Fact Sheet 1, Petroleum and Geothermal Group – Minerals and Energy Resources, <[http://www.pir.sa.gov.au/\\_\\_data/assets/pdf\\_file/0013/113341/090107\\_web.pdf](http://www.pir.sa.gov.au/__data/assets/pdf_file/0013/113341/090107_web.pdf)>
- SKM (Sinclair, Knight, Mertz in collaboration with Monash University), 2005, The geothermal resources of Victoria. Sustainable Energy Authority of Victoria, <[http://www.sustainability.vic.gov.au/resources/documents/SKM\\_Geothermal\\_Report.pdf](http://www.sustainability.vic.gov.au/resources/documents/SKM_Geothermal_Report.pdf)>
- Somerville M, Wyborn D, Chopra P, Rahman S, Estrella D and Van der Meulen T, 1994, Hot Dry Rocks Feasibility Study. Energy Research and Development Corporation. Report 243. 133pp
- WEC (World Energy Council), 2007, Survey of Energy Resources 2007, London, <[http://www.worldenergy.org/documents/ser2007\\_final\\_online\\_version\\_1.pdf](http://www.worldenergy.org/documents/ser2007_final_online_version_1.pdf)>

# Chapter 8 Hydro Energy



## 8.1 Summary

### KEY MESSAGES

- Hydroelectricity is a mature electricity generation technology and an important source of renewable energy.
- Hydroelectricity is a significant energy source in a large number of countries, although its current share in total primary energy consumption is only 2.2 per cent globally and 0.8 per cent in Australia.
- Hydroelectricity is currently Australia's major source of renewable electricity but there is limited potential for future further development.
- Water availability is a key constraint on future growth in hydroelectricity generation in Australia.
- Future growth in Australia's hydroelectricity generation will be underpinned by the development of small scale hydroelectricity facilities and efficiency gains from the refurbishment of large scale hydro plants.
- The share of hydro in Australia's total electricity generation is projected to fall to around 3.5 per cent in 2029–30.

### 8.1.1 World hydro energy resources and market

- Global technically feasible hydro energy potential is estimated to be around 16 500 TWh per year.
- World hydroelectricity generation was 3078 TWh in 2007, and has grown at an average annual rate of 2.3 per cent since 2000.
- Hydro energy is the largest source of renewable energy, and currently contributes nearly 16 per cent of world electricity production.
- In the OECD region, hydroelectricity generation is projected by the IEA to increase at an average annual rate of only 0.7 per cent between 2007 and 2030, mainly reflecting limited undeveloped hydro energy potential.
- In non-OECD countries, hydroelectricity generation is projected by the IEA to increase at an average annual rate of 2.5 per cent between 2007 and 2030, reflecting large, undeveloped potential hydro energy resources in many of these countries.

### 8.1.2 Australia's hydro energy resources

- Australia's technically feasible hydro energy potential is estimated to be around 60 TWh per year.
- Australia is the driest inhabited continent on earth, with over 80 per cent of its landmass receiving an annual average rainfall of less than 600 mm per year and 50 per cent less than 300 mm per year.

- High variability in rainfall, evaporation rates and temperatures occurs between years, resulting in Australia having very limited and variable surface water resources.
- Australia currently has 108 operating hydroelectric power stations with total installed capacity of 7.8 GW (figure 8.1).

### 8.1.3 Key factors in utilising Australia's hydro energy resources

- Potential for the development of new large scale hydroelectricity facilities in Australia is limited. However, the upgrade and refurbishment of existing hydroelectricity infrastructure will increase efficiency and extend the life of facilities.
- There is potential for small scale hydroelectricity developments in Australia, and this is likely to be an important source of future growth in capacity.
- Water availability, competition for scarce water resources, and broader environmental factors are key constraints on future growth in Australian hydroelectricity generation.

### 8.1.4 Australia's hydroelectricity market

- In 2007–08, Australia's hydroelectricity use represented 0.8 per cent of total primary energy consumption and 4.5 per cent of total electricity generation. Hydroelectricity use has declined on average by 4.2 per cent per year between 1999–00 and 2007–08, largely as a result of an extended period of drought.

226

**Figure 8.1** Major Australian operating hydro electric facilities with capacity of greater than 10 MW

**Source:** Geoscience Australia

- In 2007–08, hydroelectricity was mainly generated in the eastern states, including Tasmania (57 per cent of total electricity generation), New South Wales (21 per cent), Victoria (13 per cent) and Queensland (8 per cent).
- In ABARE's latest long-term energy projections that include the Renewable Energy Target, a 5 per cent emissions reduction target and other government policies, hydroelectricity generation is projected to increase from 12 TWh in 2007–08 to 13 TWh in 2029–30, representing an average annual growth rate of 0.2 per cent (figure 8.2).

**Figure 8.2** Australia's hydroelectricity generation to 2029–30

**Source:** ABARE 2009a, 2010

- The share of hydro in total electricity generation is projected to fall to 3.5 per cent in 2029–30.
- Hydro energy is expected to be overtaken by wind as the leading renewable source of electricity generation during the outlook period.

## 8.2 Background information and world market

### 8.2.1 Definitions

**Hydroelectricity** is electrical energy generated when falling water from reservoirs or flowing water from rivers, streams or waterfalls (run of river) is channelled through water turbines. The pressure of the flowing water on the turbine blades causes the shaft to rotate and the rotating shaft drives an electrical generator which converts the motion of the shaft into electrical energy. Most commonly, water is dammed and the

AUSTRALIAN ENERGY RESOURCE ASSESSMENT



flow of water out of the dam to drive the turbines is controlled by the opening or closing of sluices, gates or pipes. This is commonly called penstock.

Hydropower is the most advanced and mature renewable energy technology and provides some level of electricity generation in more than 160 countries worldwide. Hydro is a renewable energy source and has the advantages of low greenhouse gas emissions, low operating costs, and a high ramp rate (quick response to electricity demand).

Hydroelectricity has been used in some form since the 19th century. The main technological advantage of hydroelectricity is its ability to be used for either base or peak load electricity generation, or both. In many countries, hydro is used for peak load generation, taking advantage of its quick start-up and its reliability. Hydroelectricity is a relatively simple but highly efficient process compared with other means of generating electricity, as it does not require combustion.

### BOX 8.1 HYDROELECTRICITY TECHNOLOGIES

#### *Hydroelectricity generation*

The energy created depends on the force or strength of the water flow and the volume of water. As a result, the greater the difference between the height of the water source (head) and the height of the turbine or outflow, the greater the potential energy of the water. Hydropower plants range from very small (10 MW or less) to very large individual plants with a capacity of more than 2000 MW and vast integrated schemes involving multiple large hydropower plants. Hydropower is a significant source of base load and, increasingly, peak load electricity in parts of Australia and overseas.

Rivers potentially suitable for hydropower generation require both adequate water volume through river flows, which is usually determined by monitoring using stream gauges, and a suitable site for dam construction. In Australia virtually all hydropower is produced by stations at water storages created by dams in major river valleys. Many have facilities to pump water back into higher storage locations during off-peak times for re-use in peak times. In some cases, the hydro plant can be built on an existing dam. The development of a hydro resource involves significant time and cost because of the large infrastructure requirements. There is also a requirement for extensive investigation of the environmental impact of damming the river. This generally involves consideration of the entire catchment system.

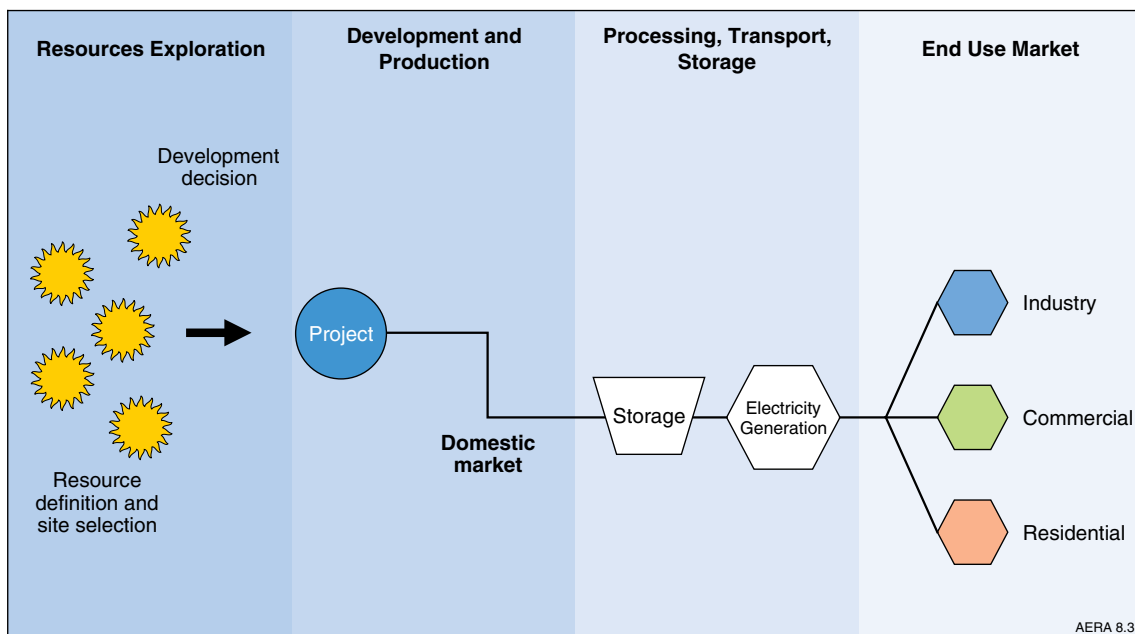
**Pumped storage hydroelectricity** stores electricity in times of low demand for use in times of high demand by moving water between reservoirs. It is currently the only commercial means of storing electricity once generated. By using excess electricity generated in times of low demand to pump water into higher storages, the energy can be stored and released back into the lower storage in times of peak demand. Pumped-storage systems can vary significantly in capacity but commonly consist of two reservoirs situated to maximise the difference in their levels and connected by a system of waterways with a pumping-generating station. The turbines may be reversible and used for both pumping and generating electricity.

Pumped storage hydroelectricity is the largest-

capacity form of grid energy storage where it can be used to cover transient peaks in demand and to provide back-up to intermittent renewable energy sources such as wind. New concepts in pumped-storage involve wind or solar energy to pump water to dams as head storage.

**Mini hydro schemes** are small-scale (typically less than 10 MW) hydroelectric power projects that typically serve small communities or a dedicated industrial plant but can be connected to an electricity grid. Some small hydro schemes in North America are up to 30 MW. The smallest hydro plants of less than 100 kW are generally termed micro hydro. Mini hydro schemes can be 'run-of-river', with no dam or water storage (see below), or developed using existing or new dams whose primary purpose is local water supply, river and lake water-level control, or irrigation. Mini hydro schemes typically have limited infrastructure requiring only small scale capital works, and hence have low construction costs and a smaller environmental impact than larger schemes. Small scale hydro has had high relative costs (\$ per MW) but is being considered both for rural electrification in less developed countries and further hydro developments in OECD countries, often supported by environmental policies and favourable tariffs for renewable energy (Paish 2002). Most recent hydropower installations in Australia, especially in Victoria, have been small (mini) hydro systems, commencing with the Thompson project in 1989.

**Run-of-river systems** rely on the natural fall (head) and flow of the river to generate electricity through power stations built on the river. Large run-of-river systems are typically built on rivers with consistent and steady flow. They are significant in some overseas locations, notably Canada and the United States. Mini run-of-river hydro systems can be built on small streams or use piped water from rivers and streams for local power generation. Run-of-river hydro plants commonly have a smaller environmental 'footprint' than large scale storage reservoirs. The Lower Derwent and Mersey Forth hydro developments in Tasmania, for example, each comprising six power stations up to 85 MW capacity, use tributary inflows and small storages in a step-like series.



**Figure 8.3** Australia's hydro energy supply chain

**Source:** ABARE and Geoscience Australia

Hydroelectricity generation is often considered a mature technology with limited scope for further development. Plants can be built on a large or small scale, each with its own characteristics:

- **Large scale hydroelectricity plants** generally involve the damming of rivers to form a reservoir. Turbines are then used to capture the potential energy of the water as it flows between reservoirs. This is the most technologically advanced form of hydroelectricity generation.
- **Small scale hydroelectricity plants**, including mini (less than 5 MW), micro (less than 500 kW) and pico facilities, are still at a relatively early stage of development in Australia, and are expected to be the main source of future growth in hydroelectricity generation. While there is no universally accepted definition of small scale hydroelectric projects, small projects are generally considered as those with less than 10 MW capacity.

Within these two broad classes of hydroelectric facilities, there are different types of technologies, including pumped storage and run-of-river (box 8.1). The type of system chosen will be determined by the intended use of the plant (base or peak load generation), as well as geographical and topographical factors. Each system has different social and environmental impacts which must be considered.

In this report, electricity generated from wave and tidal movements (coastal and offshore sources) is treated separately to that generated by harnessing the potential energy of water in rivers and dams (onshore sources). Wave and tidal energy is discussed in chapter 11.

## 8.2.2 Hydroelectricity supply chain

Figure 8.3 is a representation of hydroelectricity generation in Australia. In Australia virtually all hydroelectricity is produced by stations at water storages created by dams in major river valleys. A number have facilities to pump water back into higher storage locations during off-peak times for re-use in peak times. Electricity generated by the water turbines is fed into the electricity grid as base load and peak load electricity and transmitted to its end use market.

## 8.2.3 World hydroelectricity market

Hydro energy is a significant source of low cost electricity generation in a wide range of countries. At present, production is largely concentrated in China, North America, OECD Europe and South America. However, many African countries are planning to develop their considerable hydro energy potential to facilitate economic growth. World hydroelectricity generation is projected to grow at an average annual rate of around 2 per cent to 2030, largely reflecting the increased use of hydroelectricity in developing economies.

### Resources

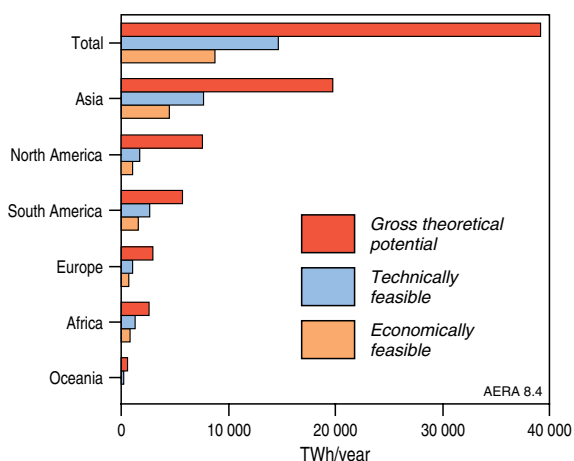
Most countries have some potential to develop hydroelectricity. There are three measures commonly used to define hydro energy resources:

- **Gross theoretical potential** – hydro energy potential that is defined by hypothesis or theory, with no practical basis. This may be based on rainfall or geography rather than actual measurement of water flows.
- **Technically feasible** – hydro energy potential that can be exploited with current technologies. This is smaller than gross theoretical potential.

- **Economically feasible** – technically feasible hydro energy potential which can be exploited without incurring a financial loss. This is the narrowest definition of potential and therefore the smallest.

The world’s total technically exploitable hydro energy potential is estimated to be around 16 500 TWh per year (WEC 2007). Regions with high precipitation (rainfall or melting snow) and significant topographic relief enabling good water flows from higher to lower altitudes tend to have higher potential, while regions that are drier, that are flat or do not have strong water flows have lower potential. Asia, Africa and the Americas have the highest feasible potential for hydroelectricity (figure 8.4).

China’s hydro energy resources are the largest of any country. China is estimated to have a theoretical potential of more than 6000 TWh per year, approximately double current world hydroelectricity generation, and economically feasible potential of more than 1750 TWh per year (Hydropower and Dams 2009). China is also home to the largest single hydroelectricity project in the world, Three Gorges.

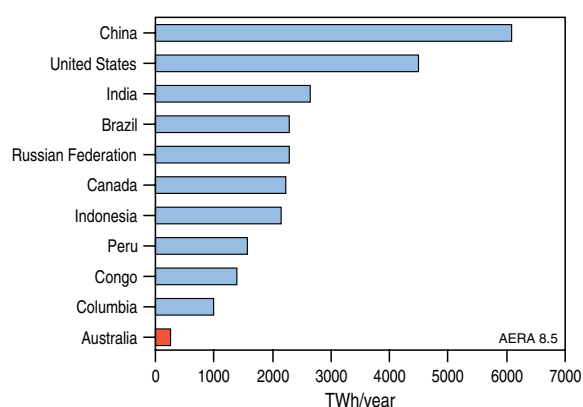


**Figure 8.4** World hydroelectricity potential, by region  
**Source:** Hydropower and Dams 2009

When completed, this site will have a capacity of 22 500 megawatts. It generated almost 50 TWh of electricity in 2006 (representing only around 31 per cent capacity utilisation), more than three times Australia’s total hydroelectricity generation.

In Africa, the Democratic Republic of the Congo has the highest hydro energy potential, while Norway’s potential resources are the highest in Western Europe. In South America, the highest hydro energy potential is in Brazil, where it exceeds 2200 TWh per year. Other countries with substantial potential include Canada, Chile, Colombia, Ethiopia, India, Mexico, Paraguay, Tajikistan and the United States. Nevertheless, almost all countries have some hydro energy potential.

Australia’s theoretical hydro energy potential (265 TWh per year) is considered to be relatively small, ranking 27th in the world (figure 8.5). High rainfall variability, low average annual rainfall over most of the continent, and high temperatures and evaporation rates limit the availability of surface water resources (WEC 2007).



**Figure 8.5** Gross theoretical hydroelectricity potential, major countries  
**Source:** Hydropower and Dams 2009

**Table 8.1** Key hydro statistics

	unit	Australia 2007–08	OECD 2008	World 2007
<b>Primary energy consumption<sup>a</sup></b>	PJ	43.4	4654	11 084
Share of total	%	0.8	2.0	2.2
Average annual growth, from 2000	%	-4.2	-0.3	2.0
<b>Electricity generation</b>				
Electricity output	TWh	12	1293	3078
Share of total	%	4.5	12.2	15.6
Electricity capacity	GW	7.8	366.9	848.5

<sup>a</sup> Energy production and primary energy consumption are identical  
**Source:** IEA 2009a; ABARE 2009a; Hydropower and Dams 2009

## Primary energy consumption

Hydroelectricity generation has been growing globally, reflecting its increasing popularity in developing economies as a relatively cheap, simple and reliable source of energy (figure 8.6).

Hydroelectricity generation accounted for 2.2 per cent of total primary energy consumption in 2007 (table 8.1). World hydroelectricity consumption has grown at an average annual rate of 2 per cent between 2000 and 2007. However, in the OECD, hydroelectricity consumption has been declining at an average annual rate of 0.3 per cent.

Consumption of hydroelectricity has also declined in Australia due to the prolonged period of drought, particularly in New South Wales and Victoria, that has affected hydroelectricity generation.

## Electricity generation

Hydroelectricity accounted for 16 per cent of world electricity generation in 2007. Hydroelectricity's share in total electricity generation has declined from 22 per cent in 1971 to 16 per cent (figure 8.6), because of the higher relative growth of electricity generation from other sources. Latin American countries account for the largest proportion of hydroelectricity generation, followed by OECD North America. The most rapid growth in hydroelectricity generation has been in China, which is now the fourth largest generator. Many African economies are also

developing their hydro energy potential, and have become a source of growth.

Total installed hydroelectricity generation capacity is currently around 849 GW, with around 158 GW of new capacity under construction in late 2008 (Hydropower and Dams 2009). Some 25–30 GW of new large scale hydro energy capacity were added in 2008, mostly in China and India (Ren21 2009). China has the world's largest installed hydroelectricity capacity with around 147 GW (17 per cent of world capacity), followed by the United States, Brazil, Canada and the Russian Federation. These economies account for half of the world's installed hydroelectricity generation capacity. In 2008 there were around 200 large (greater than 60 m high) dams with hydroelectricity facilities under construction.

The total installed capacity of small hydro energy is estimated to be about 85 GW worldwide (Ren21 2009). Most of this is in China where some 4–6 GW per year have been added for the past several years, but development of small hydro plants has also occurred in other Asian countries.

In 2007, world production of hydroelectricity was 3078 TWh (around 11 000 PJ). The largest producers were China, Brazil, Canada and the United States (figure 8.7a). Australia ranked 31st in the world. Hydroelectricity accounted for a large share of total

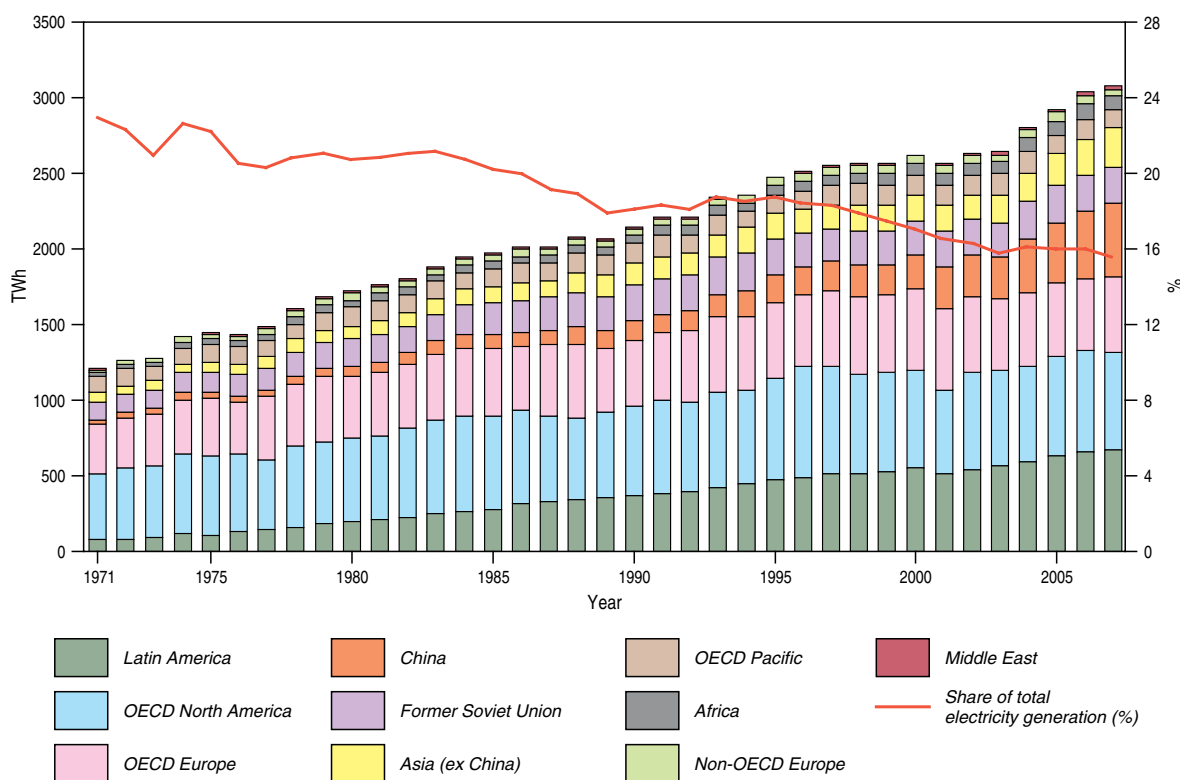
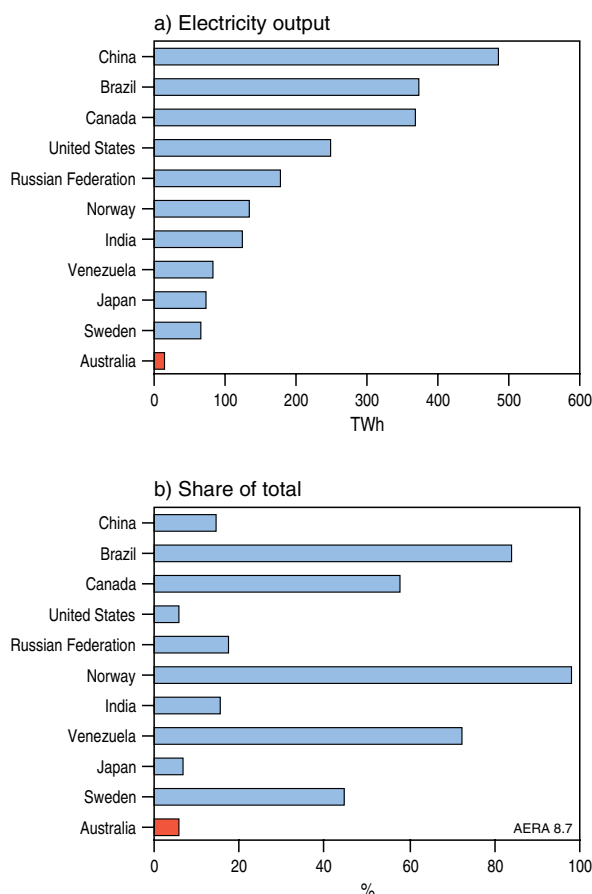


Figure 8.6 World hydro generation and share of total electricity generation

Source: IEA 2009a

AERA 8.6



**Figure 8.7** World electricity generation from hydro, major countries, 2007

Source: IEA 2009a

electricity generation in some of these countries including, most notably, Norway (98 per cent), Brazil (84 per cent), Venezuela (72 per cent), Canada (58 per cent) and Sweden (44 per cent) (figure 8.7b).

Hydroelectricity meets over 90 per cent of domestic electricity requirements in a number of other countries including: the Democratic Republic of the Congo, Ethiopia, Lesotho, Malawi, Mozambique, Namibia and Zambia in Africa; Bhutan, Kyrgyzstan, Laos, Nepal

and Tajikistan in Asia; Albania and Norway in Europe; and Paraguay in South America (Hydropower and Dams 2009).

### Outlook for the world hydroelectricity market

In the IEA reference case projections, world hydroelectricity generation is projected to increase to 4680 TWh in 2030, at an average annual rate of 1.8 per cent (table 8.2). Hydroelectricity generation is projected to grow in the OECD at an average annual rate of 0.7 per cent and in non-OECD countries by an average annual rate of 2.5 per cent.

The growth in hydroelectricity generation in the OECD is expected to come from utilisation of remaining undeveloped hydro energy resources. Growth is also expected to occur in small (including mini and micro) and medium scale hydroelectricity plants. Improvements in technology may also improve the reliability and efficiency and, hence, output of existing hydroelectricity plants, as would refurbishment of ageing infrastructure.

In non-OECD countries, growth is expected to be underpinned by the cost competitiveness of hydroelectricity compared with other means of electricity generation. Much of the growth is expected to be in small scale hydroelectricity, although there are plans in many African countries to build large scale hydroelectricity generation capacity. Growth is also expected to occur in Asia, particularly China.

The implementation of global climate change policies is likely to encourage the development of hydroelectricity as a renewable, low emissions energy source. In the IEA's 450 climate change policy scenario, the share of hydro in world electricity generation is projected to increase to 18.9 per cent in 2030, compared with 13.6 per cent in its reference case. For the OECD regions, under this scenario, the share of hydro in total electricity generation is projected to increase to 13.5 per cent in 2030 compared with 11.2 per cent in the reference case.

**Table 8.2** IEA reference case projections for world hydroelectricity generation

	unit	2007	2030
<b>OECD</b>	TWh	1258	1478
Share of total	%	12.2	11.2
Average annual growth, 2007–2030	%	-	0.7
<b>Non-OECD</b>	TWh	1820	3202
Share of total	%	19.9	15.2
Average annual growth, 2007–2030	%	-	2.5
<b>World</b>	TWh	3078	4680
Share of total	%	15.6	13.6
Average annual growth, 2007–2030	%	-	1.8

Source: IEA 2009b



## 8.3 Australia's hydro energy resources and market

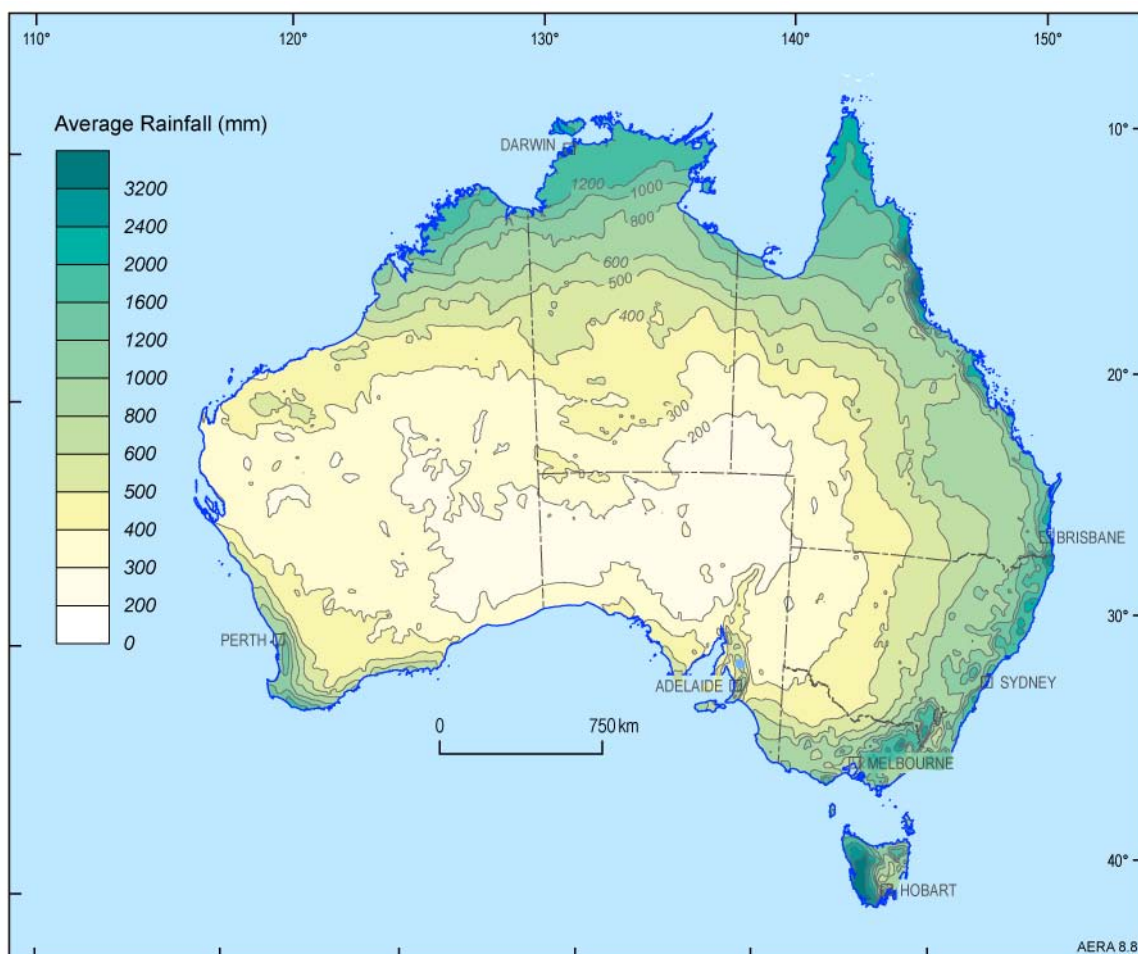
### 8.3.1 Hydro energy resources

Australia is the driest inhabited continent on earth, with over 80 per cent of its landmass receiving an annual average rainfall of less than 600 mm per year and 50 per cent less than 300 mm per year (figure 8.8). There is also high variability in rainfall, evaporation rates and temperatures between years, resulting in Australia having very limited and variable surface water resources. Of Australia's gross theoretical hydro energy resource of 265 TWh per year, only around 60 TWh is considered to be technically feasible (Hydropower and Dams 2009). Australia's economically feasible capacity is estimated at 30 TWh per year of which more than 60 per cent has already been harnessed (Hydropower and Dams 2009).

The first hydroelectric plant in Australia was built in Launceston in 1895. Australia currently has 108 operating hydroelectric power stations with total installed capacity of 7806 MW. These coincide with the areas of highest rainfall and elevation and are mostly in New South Wales (55 per cent)

and Tasmania (29 per cent) (figure 8.9). The Snowy Mountains Hydro-electric Scheme, with a capacity of 3800 MW, accounts for around half of Australia's total hydroelectricity generation capacity but considerably less of actual production. There are also hydroelectricity schemes in north-east Victoria, Queensland, Western Australia, and a mini-hydroelectricity project in South Australia. Pumped storage accounts for about 1490 MW.

The Snowy Mountains Hydro-electric Scheme is one of the most complex integrated water and hydroelectricity schemes in the world. The Scheme collects and stores the water that would normally flow east to the coast and diverts it through trans-mountain tunnels and power stations. The water is then released into the Murray and Murrumbidgee Rivers for irrigation. The Snowy Mountains Scheme comprises sixteen major dams, seven power stations (two of which are underground), a pumping station, 145 km of inter-connected trans-mountain tunnels and 80 km of aqueducts. The Snowy Mountains Hydro-electric Scheme provides around 70 per cent of all renewable energy that is available to the eastern mainland grid of Australia, as well as providing peak load power (Snowy Hydro 2007).



**Figure 8.8** Average annual rainfall across Australia

**Source:** Bureau of Meteorology

The hydroelectricity generation system in Tasmania comprises an integrated scheme of 28 power stations, numerous lakes and over 50 large dams. Hydro Tasmania, the owner of the majority of these hydroelectricity plants, supplies both base load and peak power to the National Electricity Market (NEM), firstly to Tasmania and then the Australian network through Basslink, the undersea interconnector which runs under Bass Strait.

### 8.3.2 Hydroelectricity market

Australia has developed much of its large scale hydro energy potential. Electricity generation from hydro has declined in recent years because of an extended period of drought in eastern Australia, where most hydroelectricity capacity is located. Hydro energy is becoming less significant in Australia's fuel mix for electricity generation, as growth in generation capacity is being outpaced by other fuels.

#### Primary energy consumption

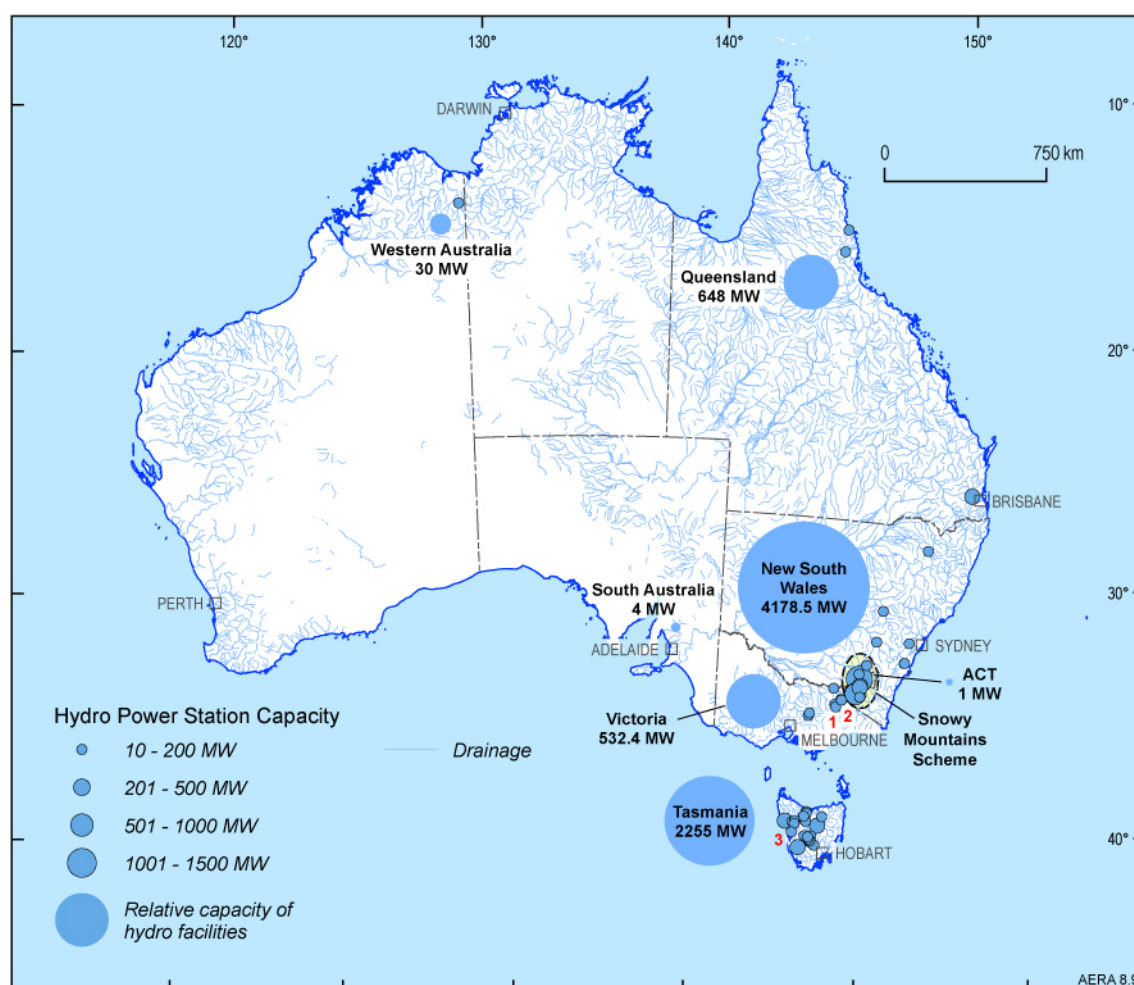
As hydro energy resources are used to produce electricity, which is used in either grid or off-grid applications, hydro energy production is equivalent to hydro energy consumption. Hydro accounted for 0.8

per cent of Australia's primary energy consumption in 2007–08. Hydroelectricity generation declined at an average annual rate of 4.2 per cent between 1999–2000 and 2007–08, the result of a prolonged period of drought.

#### Electricity generation

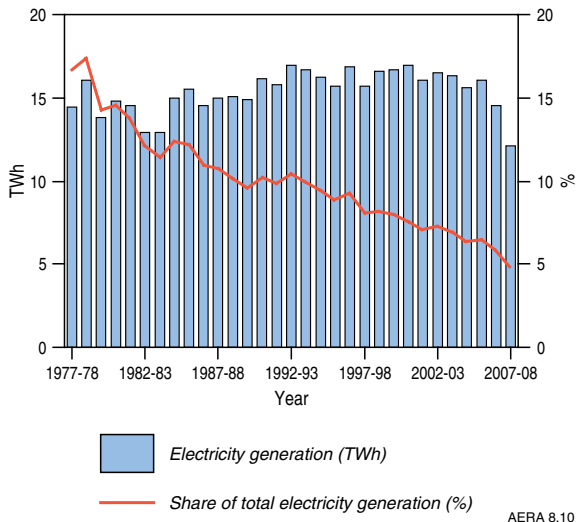
In 2007–08, Australia's hydroelectricity generation was 12.1 TWh or 4.5 per cent of total electricity generation (figure 8.10). Over the period 1977–78 to 2007–08, hydroelectricity generation has tended to fluctuate, reflecting periods of below or above average rainfall. However, the share of hydro in total electricity generation has steadily declined over this period reflecting the higher growth of alternative forms of electricity generation.

Tasmania has always been the largest generator of hydroelectricity in Australia, accounting for 57 per cent of total generation in 2007–08 (figure 8.11). New South Wales is the second largest, accounting for 22 per cent of total electricity generation in 2007–08 (sourced mostly from the Snowy Mountains Hydro-electric Scheme). Victoria, Queensland and Western Australia account for the remainder.



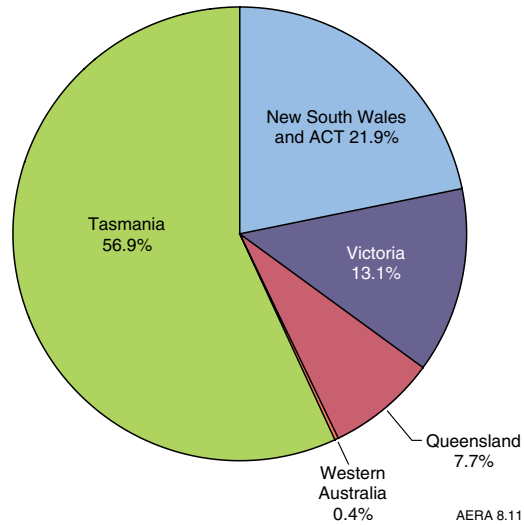
**Figure 8.9** Major Australian operating hydro electric facilities with capacity of greater than 10 MW. Numbers indicate sites referred to in section 8.4.2

**Source:** Geoscience Australia



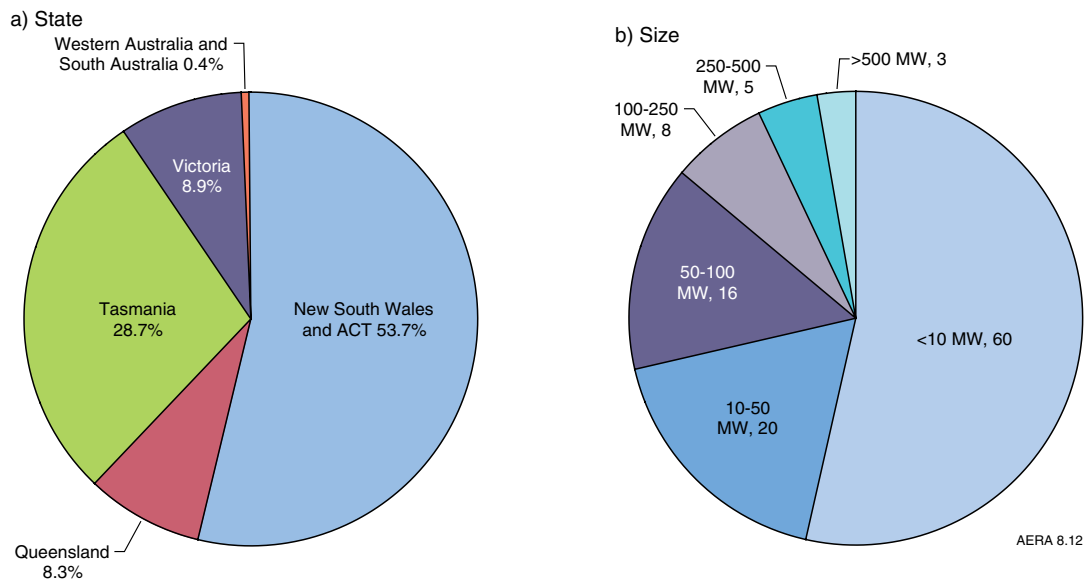
**Figure 8.10** Australia's hydro generation and share of total electricity generation

Source: ABARE 2009a



**Figure 8.11** Australia's hydro consumption by state, 2007-08

Source: ABARE 2009a



**Figure 8.12** Installed hydro capacity by state and size, 2009

Source: Geoscience Australia

### Installed electricity generation capacity

Australia has only 3 hydroelectricity plants with a capacity of 500 MW or more, all of which are located in the Snowy Mountains Hydro-electric Scheme (figure 8.12). The largest hydroelectricity plant in Australia has a capacity of 1500 MW, which is mid-sized by international standards. More than 75 per cent of Australia's installed hydroelectricity capacity is contained in 16 hydroelectricity plants with a capacity of 100 MW or more. At the other end of the scale,

there are some 60 small and mini-hydroelectricity plants (less than 10 MW capacity) with a combined capacity of just over 150 MW.

However, installed hydroelectricity generation capacity does not directly reflect actual electricity generation. The smaller installed capacity in Tasmania produces more than double the output of the Snowy Mountains Hydro-electric Scheme. Tasmania is the only state that uses hydroelectricity as the main means of electricity generation.

## 8.4 Outlook to 2030 for Australia's hydro energy resources and market

Although benefiting from the Renewable Energy Target and increased demand for renewable energy, growth in Australia's hydroelectricity generation is expected to be limited and outpaced by other renewables, especially wind energy. Future growth in hydroelectricity generation capacity is likely to come mainly from the installation of small scale plants. Water availability will be a key constraint on the future expansion of hydroelectricity in Australia.

### 8.4.1 Key factors influencing the outlook

Opportunities for further hydroelectricity generation in Australia are offered by refurbishment and efficiency improvements at existing hydroelectricity plants, and continued growth of small-scale hydroelectricity plants connected to the grid. Hydroelectricity generation is a low-emissions technology, but future growth will be constrained by water availability and competition for scarce water resources.

#### Hydroelectricity is a mature renewable electricity generation technology with limited scope for further large scale development in Australia

Most of Australia's best large scale hydro energy sites have already been developed or, in some cases, are not available for future development because of environmental considerations. There is some potential for additional hydro energy generation using the major rivers of northern Australia but

this is limited by the region's remoteness from infrastructure and markets and the seasonal flows of the rivers.

#### Upgrading and refurbishing ageing hydro infrastructure in Australia will result in capacity and efficiency gains

Many of Australia's hydroelectric power stations are now more than 50 years old and will require refurbishment in the near future. This will involve significant expenditure on infrastructure, including the replacement and repair of equipment. The refurbishment of plants will increase the efficiency and decrease the environmental impacts of hydroelectricity. Further technology developments will be focused on efficiency improvements and cost reductions in both new and existing plants (box 8.2).

The Snowy Hydro Scheme is currently undergoing a maintenance and refurbishment process, at a cost of approximately A\$300 million (in real terms) over seven years (Snowy Hydro 2009). The modernisation will include the replacement of ageing and high maintenance equipment, increasing the efficiency and capacity of turbines, and ensuring the continued reliable operation of the component systems of the scheme.

Refurbishment of the power station at Lake Margaret, Tasmania – one of Australia's oldest hydroelectricity facilities (commissioned in 1914) – commenced in 2008. The main objective of the project was to repair the original wooden pipeline, which had deteriorated

### BOX 8.2 HYDROELECTRICITY COSTS

#### Hydroelectricity generation costs

The most significant cost in developing a hydro resource is the construction of the necessary infrastructure. Infrastructure costs include the dams as well as the power plant itself. Building the plant on an existing dam will significantly reduce capital outlays. Costs incurred in the development phase of a hydro facility include (Forouzbakhsh et. al. 2007):

- **Civil costs** – construction of the components of the project including dams, headponds, and access roads.
- **Electro mechanical equipment costs** – the machinery of the facility, including turbines, generators and control systems.
- **Power transmission line costs** – installation of the transmission lines.

Indirect costs include engineering, design, supervision, administration and inflation impacts on costs during the construction period. Construction of small and medium plants can take between 1 to

6 years, while for large scale plants it can take up to 30 years (for example, the Snowy Hydro Scheme took 25 years to build).

The costs of building Australian hydroelectricity generation plants have been varied. The Snowy Hydro scheme, Australia's largest hydroelectricity scheme, was constructed over a period of 25 years at a cost of A\$820 million (Snowy Hydro 2007). Australia's most recent major hydroelectric development, the Bogong project (site 1, figure 8.9), commenced construction in 2006 and was commissioned in late 2009 at a cost of around \$234 million. The project – which includes the 140 MW Bogong power station, a 6.9 km tunnel, head works and a 220 kV transmission line – will provide fast peaking power. In comparison, the Ord River hydroelectricity scheme, which was built on the existing dam which created Lake Argyle in Western Australia, was constructed at a cost of A\$75 million (Pacific Hydro 2009). While this plant is relatively small



(30 MW), it demonstrates the potential reduction in construction costs where an existing dam can be used.

While hydroelectricity has high construction and infrastructure costs, it has a low cost of operation compared to most other means of electricity generation. In the OECD, capital costs of hydroelectric plants are estimated at US\$2400 per kW, and operating costs are estimated at between US\$0.03 and US\$0.04 per kWh (IEA 2008). For non-OECD

countries, capital costs are often below US\$1000 per kW. The operating costs of small hydroelectricity facilities are estimated at between US\$0.02 and US\$0.06 per kWh. Operating and capital costs depend on the size and type (for example, run-of-river) of plant, and whether it includes pumped storage capabilities. Most hydroelectric plants have a lifetime of over 50 years, during which minimal maintenance or refurbishment is required, so the relatively high capital costs are amortised over a long period.

(Hydro Tasmania 2008). The project involved additional maintenance on the dam, minor upgrade of the machines, as well as replacement of a transformer. This upgrade, completed in late 2009, cost about \$14.7 million to gain 8.4 MW of capacity at a capital spend rate of \$1.75 million per MW, considerably less than the costs of new plant. Work has commenced on the redevelopment of the Lower Margaret Power Station (Hydro Tasmania 2009).

### **Small scale hydro developments are likely to be an important source of future growth in Australia**

With the exception of the Bogong project (see Proposed development projects in section 8.4.2), most hydroelectricity plants installed in Australia in recent years have been mini hydro schemes. These plants have the advantage of lower water requirements and a smaller environmental impact than larger schemes, especially those with large storage dams.

Although most of Australia's most favourable hydroelectricity sites have been developed, mini hydroelectricity plants are potentially viable on smaller rivers and streams where large dams are not technically feasible or environmentally acceptable. They can also be retro-fitted to existing water storages. At present mini hydro plants account for only around 2 per cent of installed hydro capacity. Research, development and demonstration activity is likely to increase the cost competitiveness of small scale hydro schemes in the future (box 8.3).

### **Surface water availability and competition for scarce water resources will be a key constraint to future hydro developments in Australia**

Australia has a high variability of rainfall across the continent (figure 8.8). This means that annual inflows to storages can vary by up to 50 per cent and seasonal variations can be extreme. Ongoing drought in much of south eastern Australia has seen a substantial decline in water levels in the major storages in New South Wales (notably the Snowy Mountains scheme), Victoria and Tasmania and declining capacity factors for hydroelectricity stations. Water levels in storages across Australia have declined

to an average of below 50 per cent of capacity (National Water Commission 2007). Cloud seeding has been used in the Snowy Mountains and in Tasmania to augment water supplies.

Climate change models suggest the outlook for south eastern Australia is for drier conditions with reduced rainfall and higher evaporation, and a higher frequency of large storms (BOM 2009; IPCC 2007; Bates et al. 2008). Reduced precipitation and increased evaporation are projected to intensify by 2030, leading to water security problems in southern and eastern Australia in particular (Hennessy et al. 2007). The climate change projections further exacerbate the problem of Australia's dry climate with low and variable rainfall, low run off and unreliable water flows and mean that there is only limited potential for further major hydro development in mainland Australia. Some of this potential is located in the rivers in northern Australia, but this is limited by the inconsistency of water flows in this region (periods of low rainfall along with periods of flooding).

Competition for water resources will also affect the availability of water for hydroelectricity generation. Demand for water for urban and agricultural uses is projected to increase. It is likely that these uses for scarce water resources will take precedence over hydroelectricity generation. Generators face increasing demands to balance their needs against the need for greater water security for cities and major inland towns. The maintenance of environmental flows to ensure the environmental sustainability of river systems below dams is also an important future consideration which may further constrain growth of hydroelectricity generation.

Water policies may also play a role in the future development of hydroelectricity in Australia. Policies that limit the availability of water to hydroelectricity generators, restrict the flow of water into dams, require generators to let water out of dams, or prioritise the use of water for agriculture could change the viability of many hydroelectric generators, and limit future growth. The extended drought in much of Australia has led to water restrictions being put into place in most capital cities, and regulation of the Murray-Darling basin river systems has strengthened.



### BOX 8.3 TECHNOLOGY DEVELOPMENTS IN HYDROELECTRICITY

Research is being undertaken to improve efficiency, reduce costs, and to improve the reliability of hydroelectricity generation. There are different research needs for small and large scale hydro (table 8.3). Small hydropower plants, including micro and pico plants, are increasingly seen as a viable source of power because of their lower development costs and water requirements, and their lower environmental footprint. Small scale hydropower plants require special technologies to increase the efficiency of electricity generation and thereby minimise both the operating costs and environmental impacts of hydroelectricity generation (ESHA 2006).

The environmental impacts of hydroelectricity are also being investigated, and ways to mitigate these impacts developed. This includes the development of new and improved turbines designed to minimise the impact on fish and other aquatic life and to increase dissolved oxygen in the

water. The introduction of greaseless bearings in the turbines would reduce the risk of petroleum products entering the water, and is also currently being investigated (EERE 2005).

**Table 8.3** Technology improvements for hydropower

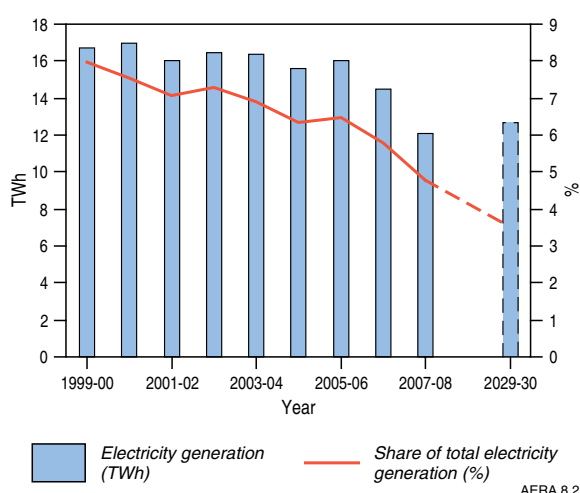
Large hydro	Small hydro
<b>Equipment</b> Low-head technologies, including in-stream flow Communicate advances in equipment, devices and materials	<b>Equipment</b> Turbines with less impact on fish populations Low-head turbines In-stream flow technologies
<b>Operation and maintenance</b> Increasing use of maintenance-free and remote operation technologies	<b>Operation and maintenance</b> Develop package plants requiring only limited operation and maintenance
	<b>Hybrid systems</b> Wind-hydro systems Hydrogen-assisted hydro systems

Source: IEA 2008

#### 8.4.2 Outlook for hydroelectricity market

Hydroelectricity is projected to continue to be an important source of renewable energy in Australia over the outlook period.

In ABARE's latest long-term energy projections that include the Renewable Energy Target, a 5 per cent emissions reduction target and other government policies (ABARE 2010), hydroelectricity generation is projected to increase only slightly between 2007–08 and 2029–30, representing an average annual growth rate of 0.2 per cent. In 2029–30, hydro is projected to account for 3.5 per cent of Australia's total electricity generation, and 0.6 per cent of primary



**Figure 8.13** Australia's hydroelectricity generation to 2029–30

Source: ABARE 2009a, 2010

energy consumption (figure 8.13). The potential for return of hydroelectricity output to pre-2006 levels will be strongly influenced by climate and by water availability.

#### Proposed development projects

Based on Hydropower and Dams (2009), there are several current hydro project developments in Australia:

- A 20 MW hydro plant is currently under construction at the Dartmouth regulating dam in Victoria (Site 2, figure 8.9).
- The next stage of redevelopment of the 8.4 MW Lake Margaret power station in Tasmania has been approved by the board of Hydro Tasmania (Site 3, figure 8.9).
- Hydro Tasmania Consulting has been awarded a contract to supply and construct six mini hydro plants for Melbourne Water with a total capacity of 7 MW, producing up to 40 GWh per year.

## 8.5 References

ABARE (Australian Bureau of Agricultural and Resource Economics), 2009a, Australian Energy Statistics, Canberra, August

ABARE, 2009b, Major electricity development projects – October listing, Canberra, November

ABARE, 2010, Australian energy projections to 2029–30, ABARE research report 10.02, prepared for the Department of Resources, Energy and Tourism, Canberra

Geoscience Australia, 2009, map of operating renewable energy generators in Australia, Canberra

Bates BC, Kundzewicz ZW, Wu S & Palutikof JP (eds), 2008, Climate change and water, IPCC Technical Paper VI, IPCC Secretariat, Geneva, <[http://www.ipcc.ch/publications\\_and\\_data/publications\\_and\\_data\\_technical\\_papers\\_climate\\_change\\_and\\_water.htm](http://www.ipcc.ch/publications_and_data/publications_and_data_technical_papers_climate_change_and_water.htm)>

Bureau of Meteorology (BOM), 2009, The Greenhouse Effect and Climate Change, BOM, Melbourne, <<http://www.bom.gov.au/info/GreenhouseEffectAndClimateChange.pdf>>

EERE, 2005, Hydropower research and development, Energy Efficiency and Renewable Energy, US Department of Energy, Washington, August

Egre D & Milewski J, 2002, The diversity of hydropower projects, Energy Policy, vol. 30, pp. 1225–1230

ESHA, 2006, State of the Art of Small Hydropower in EU-25, European Small Hydropower Association, Belgium

Forouzbakhsh F, Hosseini SMH & Vakilian M, 2007, An approach to the investment analysis of small and medium hydro-power plants, Energy Policy, vol. 35, pp. 1013–1024, Elsevier, Amsterdam

Hennessy K, Fitzharris B, Bates BC, Harvey N, Howden SM, Hughes L, Salinger J & Warrick, R, 2007, Australia and New Zealand. Climate Change 2007: Impacts, Adaptation and Vulnerability. Contribution of Working Group II to the Fourth Assessment Report of the Intergovernmental Panel on Climate Change, ML Parry, OF Canziani, JP Palutikof, PJ van der Linden and CE Hanson eds., Cambridge University Press, Cambridge, UK, 507-540

Hydropower and Dams, 2009, World Atlas 2008, The International Journal on Hydropower & Dams, Aqua-Media International, Surrey

Hydro Tasmania, 2008, Lake Margaret Power Scheme, Hobart, <[http://www.hydro.com.au/documents/Energy/Lake\\_Margaret\\_FAQ\\_200811.pdf](http://www.hydro.com.au/documents/Energy/Lake_Margaret_FAQ_200811.pdf)>

Hydro Tasmania, 2009, Annual and Sustainability Report, 2009, <[http://www.hydro.com.au/documents/Corporate/Annual%20Reports/2009/Hydro\\_AR.html](http://www.hydro.com.au/documents/Corporate/Annual%20Reports/2009/Hydro_AR.html)>

IEA (International Energy Agency), 2008, Energy technology perspectives: scenarios and strategies to 2050, OECD, Paris

IEA, 2009a, World Energy Balances, 2009, OECD, Paris

IEA, 2009b, World Energy Outlook 2009, OECD, Paris

IEA, 2009, World Energy Outlook, OECD, Paris

Intergovernmental Panel on Climate Change (IPCC), 2007, IPCC Fourth Assessment Report: Climate Change 2007 (AR4), Geneva, <[http://www.ipcc.ch/publications\\_and\\_data/publications\\_and\\_data\\_reports.htm](http://www.ipcc.ch/publications_and_data/publications_and_data_reports.htm)>

National Water Commission, 2007, A baseline assessment of water resources for the National Water Initiative – Level 2 Assessment, Canberra, May

Pacific Hydro, 2009, Ord River Hydro factsheet, Melbourne, <<http://www.pacifichydro.com.au/en-us/our-projects/australia-pacific/ord-river-hydro-project.aspx>>

Paish O, 2002, Small hydro power: technology and current status. Renewable and Sustainable Energy Reviews, vol. 6, pp. 537–556, Elsevier, Amsterdam

Ren21, 2009, Renewables global status report, 2009 update, Renewable Energy Policy Network for the 21st Century, Paris

Snowy Hydro, 2007, Snowy Mountains Scheme, Sydney, <<http://www.snowyhydro.com.au/levelTwo.asp?pageID=66&parentID=4>>

Snowy Hydro, 2009, Scheme Modernisation Project, Sydney, <<http://www.snowyhydro.com.au/levelTwo.asp?pageID=340&parentID=4>>

WEC (World Energy Council), 2007, Survey of Energy Resources 2007, London, September

# Chapter 9

## Wind Energy



### 9.1 Summary

#### KEY MESSAGES

- Wind resources are a substantial source of low to zero-emission renewable energy, with a proven technology. Wind farms with installed capacities of more 100 megawatts (MW) are now common.
- Australia has some of the world’s best wind resources along its south-western, southern and south-eastern margins. More isolated areas of the eastern margin also have excellent wind resources.
- Wind energy is the fastest growing renewable energy source for electricity generation, although its current share of total primary energy consumption is only 0.2 per cent in Australia.
- Further rapid growth in wind energy in Australia will be encouraged by government policies, notably the Renewable Energy Target (RET) and emissions reduction targets, increased demand for low emission renewable energy and lower manufacturing costs.
- In Australia, the share of wind energy in total electricity generation is projected to increase from 1.5 per cent in 2007–08 to 12.1 per cent in 2029–30.
- Extension and other augmentation of the electricity transmission network may be required to access dispersed (remote) wind energy resources and to integrate the projected increase in wind energy electricity generation.

#### 9.1.1 World wind energy resources and market

- The world’s wind energy resource is estimated to be around one million gigawatts (GW) for total land coverage. The windiest areas are typically coastal regions of continents at mid to high latitudes, and mountainous regions.
- Wind electricity generation is the fastest growing energy source, increasing at an average annual rate of nearly 30 per cent between 2000 and 2008. The major wind energy producers are Germany, the United States, Spain, India and China.
- The world outlook for electricity generation from wind energy will be strongly influenced by government climate change policies and the demand for low-emission renewable energy at affordable prices.
- The IEA projects the share of wind energy in total electricity generation will increase markedly from 0.9 per cent in 2007 to 4.5 per cent in 2030 – from 1.4 per cent to 8.1 per cent in OECD countries and from 0.3 per cent to 2.2 per cent in non-OECD countries.

#### 9.1.2 Australia’s wind energy resources

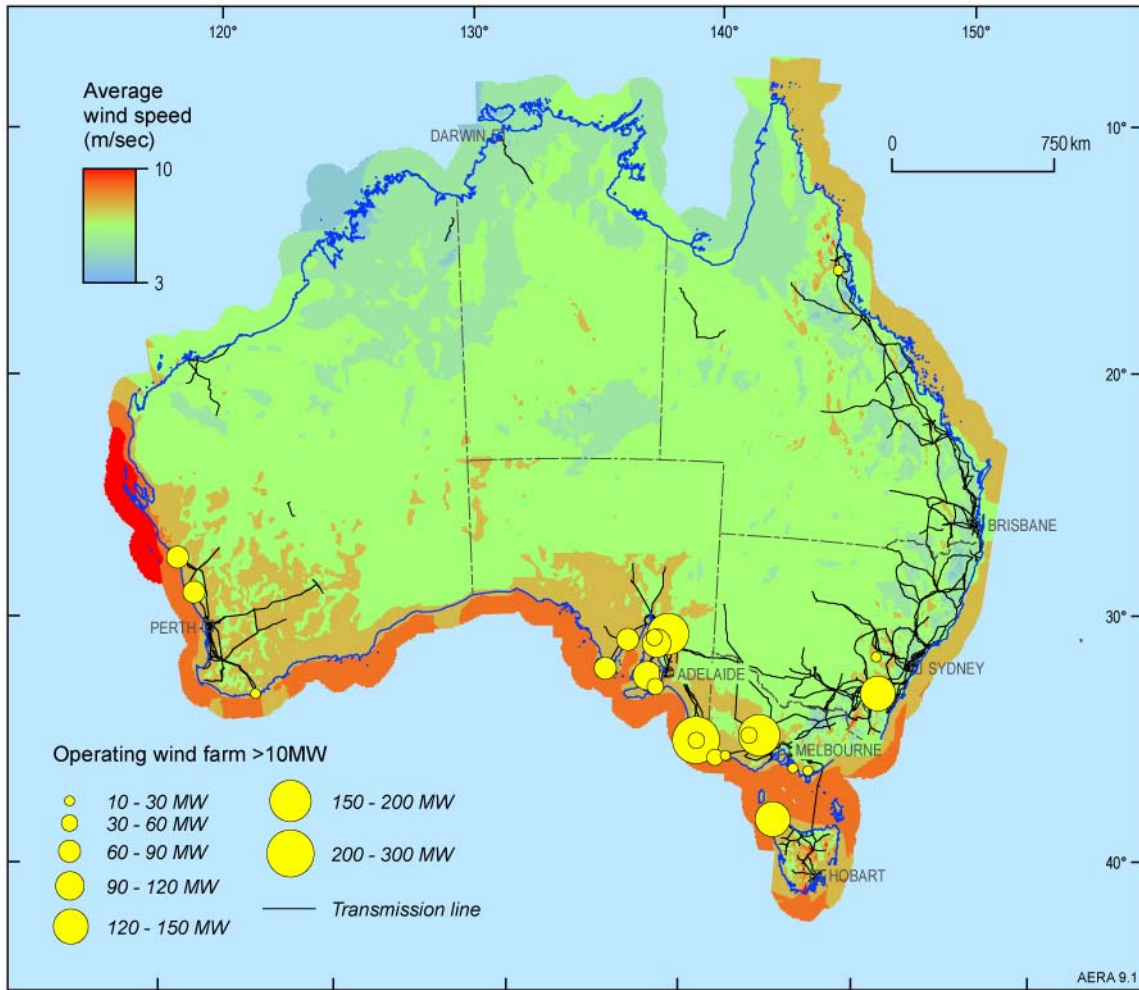
- Australia has some of the best wind resources in the world, primarily located in western, south-western, southern and south-eastern coastal

regions but extending hundreds of kilometres inland and including highland areas in south-eastern Australia (figure 9.1). There are large areas with average wind speeds suitable for high yield electricity generation.

- Local topography and other variability in the local terrain such as surface roughness exert a major influence on wind speed and wind variability. This necessitates detailed local investigation of potential sites for wind farms.

#### 9.1.3 Key factors in utilising Australia’s wind energy resources

- Government policies, particularly carbon emissions reduction targets and the Renewable Energy Target (RET), are expected to underpin the future growth of Australia’s wind energy industry. The operation of wind turbines produces no greenhouse gas emissions, and emissions involved in the development stage are low compared with electricity generation from other sources.
- Wind energy is a proven and mature technology with low operating costs. Both the size of turbines and wind farms have increased, with farms of more than 100 MW combined capacity now common and substantially larger wind farms proposed.



**Figure 9.1** Australia's wind resources

**Source:** Windlab Systems Pty Ltd, DEWHA Renewable Energy Atlas (wind map data); Geoscience Australia

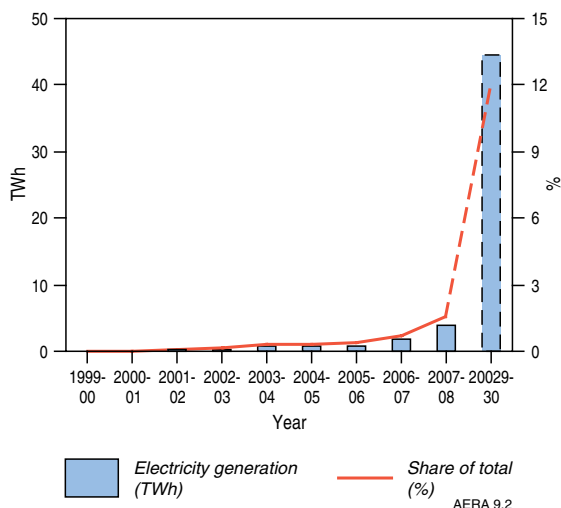
- Grid constraints – lack of capacity or availability – may limit further growth of wind energy in some areas with good wind resources, particularly in South Australia. In such areas, upgrades and extensions to the current grid may be needed to accommodate significant further wind energy development. Elsewhere, current grid infrastructure should be adequate for the levels of wind energy penetration projected for 2030.
- Variability imposes an upper limit on wind energy penetration, however this is not likely to be reached at the level of wind energy projected to 2030. This limit can be extended by better wind forecasting (allowing the grid to react to projected changes in wind conditions), demand side management (shedding or adding load to match wind conditions) and even the addition of storage nodes to the grid (moving excess wind energy to higher demand periods).
- Wind turbine manufacturing output is doubling every three years. There is also a shift from

European and United States' production to lower cost manufacturing centres in India and China. Both of these trends will result in a reduction in turbine costs.

- Access to Australia's onshore wind resources is likely to be sufficient to meet industry development requirements over the outlook period. There are currently no plans to develop higher cost offshore wind resources.

#### 9.1.4 Australia's wind energy market

- In 2007–08, Australia's wind energy use represented only 0.2 per cent of total primary energy consumption and 1.5 per cent of total electricity generation. However, wind energy is the fastest growing energy source in Australia with an average annual growth of 69.5 per cent since 1999–00.
- In October 2009, there were 85 wind farms in Australia with a combined installed capacity of 1.7 GW. These power stations are mainly located in South Australia (48 per cent), Victoria (23 per



**Figure 9.2** Australia's wind energy market to 2029–30

Source: ABARE 2010

cent) and Western Australia (12 per cent).

A further 11.3 GW of wind energy capacity has been proposed for development in Australia.

- In the latest ABARE long-term energy projections that include a 5 per cent emissions reduction target, wind electricity generation in Australia is projected to increase sharply from 4 TWh in 2007–08 to 44 TWh in 2029–30 (figure 9.2). The share of wind energy in total electricity generation is projected to increase from 1.5 per cent in 2007–08 to 12.1 per cent in 2029–30.

## 9.2 Background information and world market

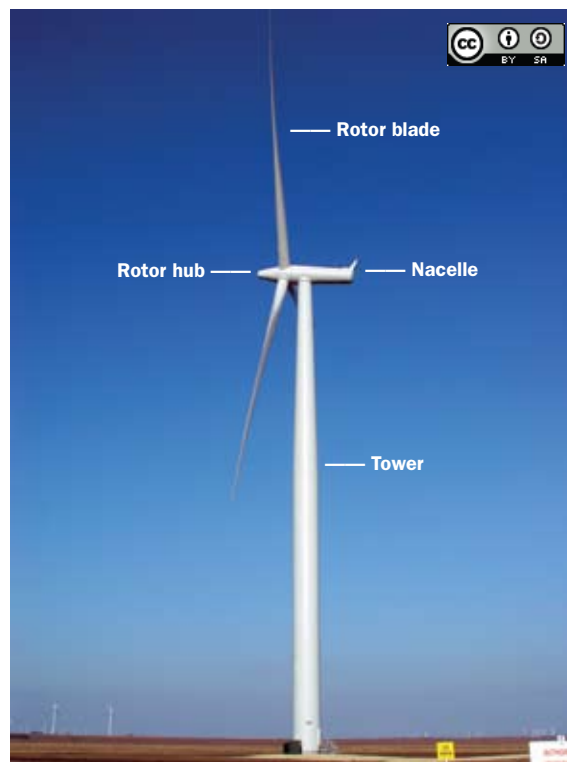
### 9.2.1 Definitions

Wind is a vast potential source of renewable energy. Winds are generated by complex mechanisms involving the rotation of the Earth, the heat capacity of the Sun, the cooling effect of the oceans and polar ice caps, temperature gradients between land and sea, and the physical effects of mountains and other obstacles.

Wind energy is generated by converting wind currents into other forms of energy using wind turbines (figure 9.3). Turbines extract energy from the passing air by converting kinetic energy from rotational movement via a rotor. The effectiveness of this conversion at any given site is commonly measured by its energy density or, alternatively, as a capacity factor (box 9.1). Wind energy is primarily used for electricity generation, both onsite and for transport to the grid. Wind energy is also used to pump bore water, particularly in rural areas.

### 9.2.2 Wind energy supply chain

The wind energy supply chain is relatively simple (figure 9.4). In the energy market, wind resources are utilised for electricity generation, either linked to the grid or for off-grid applications in remote areas. Wind



**Figure 9.3** A modern wind turbine

Source: Wikimedia Commons

### BOX 9.1 CAPACITY FACTOR

Estimates of electricity generation are generally calculated by modelling the interaction between the wind distribution and a particular turbine. The ratio of actual yield to the maximum output of the machine is commonly referred to as a capacity factor. Each type of turbine has a different capacity factor for any given site.

For example, a wind turbine with a 1 MW capacity and 30 per cent capacity factor will not produce its theoretical maximum annual production of 8760 MWh ( $1\text{MW} \times 24 \text{ hours} \times 365 \text{ days}$ ). Rather it is expected to produce 2628 MWh ( $1\text{MW} \times 24 \text{ hours} \times 365 \text{ days} \times 0.3 \text{ capacity factor}$ ).

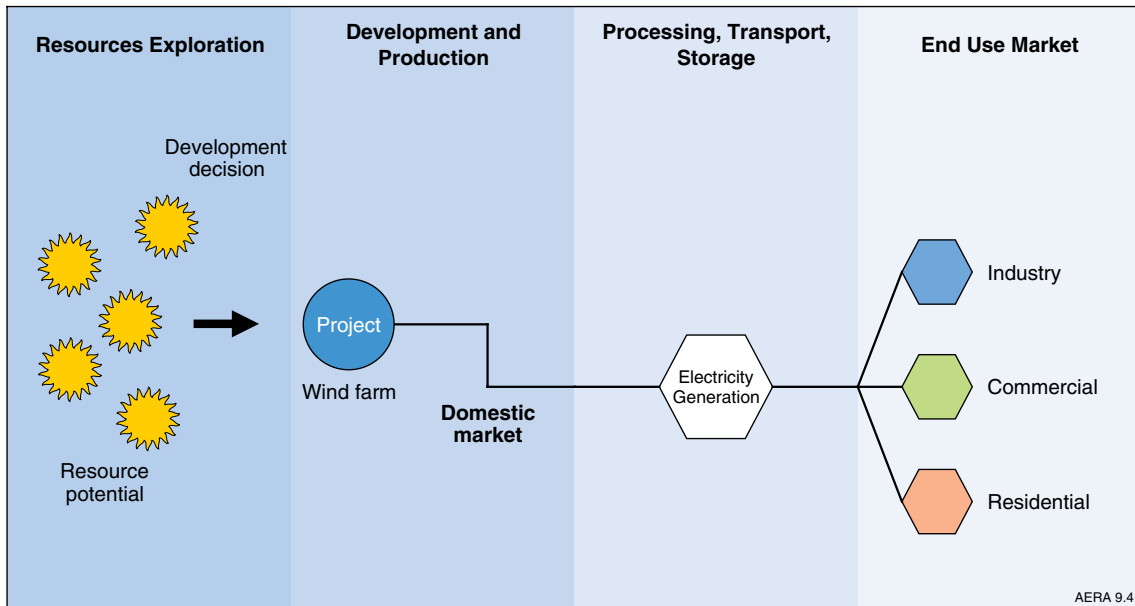
The capacity factor should not be confused with 'efficiency' which is a measure comparing the actual output with the energy contained in the passing wind. Wind turbines are limited by physical factors to an efficiency of about 60 per cent (Betz's Law). The best wind turbines are presently around 44 per cent efficient.

resources are also used to pump water, especially in rural Australia.

Modern wind energy prospecting typically uses three levels of wind resource mapping:

1. regional-scale 'mesoscale' wind speed maps, to identify favourable regions. These maps are





**Figure 9.4** Australia's wind energy supply chain

**Source:** ABARE and Geoscience Australia

compiled using wind measurements from balloons combined with atmospheric models;

2. farm level 'microscale' wind resource mapping to account for local variations in wind speed; and
3. micro-siting studies to determine optimal locations for siting of individual turbines. This mapping requires input from long term sensors installed on the site.

Final siting of wind farms depends on both technical and commercial factors, including wind speed and topography, as well as proximity to transmission lines, access to land, transport access, local development zoning and development guidelines, and proximity to markets.

In the electricity market, wind energy is automatically dispatched, meaning that the wind electricity must be consumed before other, more controllable, sources are dispatched. Since March 2009 new wind generators greater than 30 MW must be classified as 'semi-scheduled' and participate in the central dispatch process (AER 2009).

Electricity produced from the individual turbines is stepped up by means of a transformer and high voltage switch and collected in the central switchyard of the wind farm. It is then fed to the electricity transmission grid substation with further transformers and switchgear. The electricity is distributed to the industrial, commercial and residential markets in the same manner as electricity generated from any other source.

Small wind turbines (typically less than 10 kW) are commonly used in remote locations isolated from the grid for a variety of industrial, commercial and

household needs, usually in conjunction with some form of storage.

### 9.2.3 World wind energy market

The wind energy industry is the fastest growing renewable energy source in many countries and is expected to continue to grow rapidly over the period to 2030. Production of wind energy is largely concentrated in Europe and the United States. However, there has also been rapid growth in the wind energy industries in China and India.

#### Resources

The world's wind energy resource is estimated to be about one million GW for total land coverage. Assuming only 1 per cent of the area is utilised and allowance is made for the lower load factors of wind plant, the wind energy potential would correspond to around the world total electricity generation capacity (WEC 2007).

The windiest areas are typically coastal regions of continents at mid-to high latitudes and in mountainous regions. Locations with the highest wind energy potential include the westerly wind belts between latitudes 35° and 50°. This includes the coastal regions of western and southern Australia, New Zealand, southern South America, and South Africa in the southern hemisphere, and northern and western Europe, and the north eastern and western coasts of Canada and the United States. These regions are generally characterised by high, relatively constant wind conditions, with average wind speeds in excess of 6 metres per second (m/s) and, in places, more than 9 m/s.

Regions with high wind energy potential are characterised by:

**Table 9.1** Key wind energy statistics, 2008

	unit	Australia 2007–08	OECD 2008	World 2008 <sup>a</sup>
<b>Primary energy consumption<sup>b</sup></b>	PJ	14.2	660.2	767.8
Share of total	%	0.2	0.3	0.1 <sup>c</sup>
Average annual growth, 2000–2008	%	69.5	26.2	27.7
<b>Electricity generation</b>				
Electricity output	TWh	3.9	183.4	213.3
Share of total	%	1.5	1.7	0.9 <sup>c</sup>
Electricity capacity	GW	1.3	104.3	120.8

<sup>a</sup> ABARE estimate <sup>b</sup> Energy production and primary energy consumption are identical <sup>c</sup> 2007 data

**Source:** ABARE 2009a; IEA 2009a; GWEC 2009a

- high average wind speeds;
- winds that are either constant or coinciding with peak energy consumption periods (during the day or evening);
- proximity to a major energy consumption region (i.e. urban/industrial areas); and
- smooth landscape, which increases wind speeds, and reduces the mechanical stress on wind turbine components that results from variable and turbulent wind conditions associated with rough landscape.

Because of wind variability, the energy density at a potential site – commonly described as its **capacity factor** (box 9.1) – is generally in the range of 20–40 per cent. While the majority of areas in locations convenient for electricity transfer to the grid are located onshore, offshore sites have also been identified as having significant potential for wind energy, both to take advantage of increased wind speeds and to increase the number of available sites. Offshore locations also help reduce turbulence and hence stress on machine components. There have been wind turbines deployed in shallow seas off northern Europe for more than a decade. Offshore sites are expected to make an increasingly significant contribution to electricity generation in some countries, notably in Europe, where there are increasing difficulties in gaining access to onshore sites.

### Primary energy consumption

In the wind energy market, energy production, primary energy consumption and fuel inputs to electricity generation are the same as there is essentially no international trade and no ability to hold stocks of wind energy. Wind energy has increased from a 0.03 per cent share of global primary energy consumption in 2000 to around 0.1 per cent in 2007 (IEA 2009a).

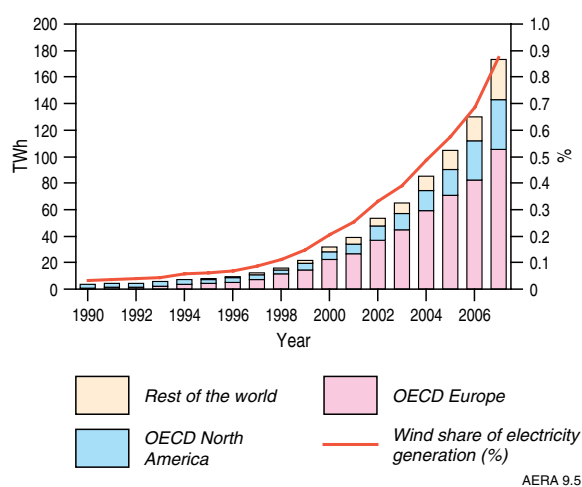
### Electricity generation

Wind energy accounted for 0.9 per cent of world

electricity generation in 2007 and 1.7 per cent of OECD electricity generation in 2008. Global wind electricity generation has increased strongly, from 31 terawatt-hours (TWh) in 2000 to 213 TWh in 2008, representing an average annual growth rate of nearly 28 per cent (table 9.1).

Wind energy use is growing rapidly in the industrialised world: capacity has been doubling about every three and half years since the early 1990s. The reasons for this rapid growth are environmental; it is a renewable and low emission source of energy. Because of the simplicity of its technology and resource abundance, it has emerged as one of the leading renewable energy industries, well aligned with governments' search for commercially-viable renewable energy sources. There is also increasing interest in the developing world because it can be readily installed to meet local electricity needs.

The wind energy market is dominated by two regions: Europe and North America (figure 9.5). In 2007, 61 per cent of the world's wind electricity generation was

**Figure 9.5** World wind electricity generation, by region

**Source:** IEA 2009a

in OECD Europe and 22 per cent was in OECD North America, mainly in the United States.

The main wind energy producers in Europe are Germany (23 per cent of world wind electricity generation in 2007), Spain (16 per cent) and Denmark (4 per cent) (figure 9.6a). While growth in wind electricity generation in these countries has slowed in recent years, other major producers have emerged, including the United Kingdom, France and Italy. The strong presence of the wind energy industry in the European Union, where it is the fastest growing energy source, is largely the result of government initiatives to have renewable energy sources provide 21 per cent of electricity generation by 2010 (Commission of the European Communities 2005).

The United States produced 35 TWh of wind energy in 2007, accounting for 20 per cent of world wind energy production. Currently, the strongest legislative support for the wind energy industry is a 2.1 cents per kWh tax credit allowed for the production of electricity from utility scale wind turbines (the Wind Energy Production Tax Credit). In addition, renewable portfolio standard (RPS) policies with targets for a renewable share of electricity generation have been implemented in 28 US states. A proposed national RPS, which would be similar to Australia's Renewable Energy Target, is before the United States Congress.

In Asia, India (with 7 per cent of world wind electricity generation in 2007) and China (5 per cent) have emerged as significant wind energy producers. India has supported the development of the wind energy industry through research and development support, demonstration projects and policy support. China's National Energy Bureau identified wind energy as a priority for diversifying China's energy mix away from coal. Both countries are now manufacturers and exporters of wind turbines.

Wind energy contributes a significant proportion of electricity in some countries, particularly Denmark (19 per cent in 2007), Portugal (13 per cent), Spain (10 per cent) and Germany (6 per cent) (figure 9.6b).

Australia is the fourteenth largest wind producer in the world (figure 9.6a). However, wind energy accounted for only 1.5 per cent of Australia's total electricity generation in 2007–08 (table 9.1).

### Installed electricity generation capacity

Global installed wind energy capacity has risen sharply from 6.1 GW in 1996 to 121.5 GW in 2008 (table 9.2). In 2008, 27 GW of new capacity was installed, an annual increase of 29 per cent, with more than half of the new capacity developed in the United States and China.

At the end of 2008 the United States had the highest installed capacity (25 GW) followed by Germany (24 GW), Spain (17 GW), China (12 GW)

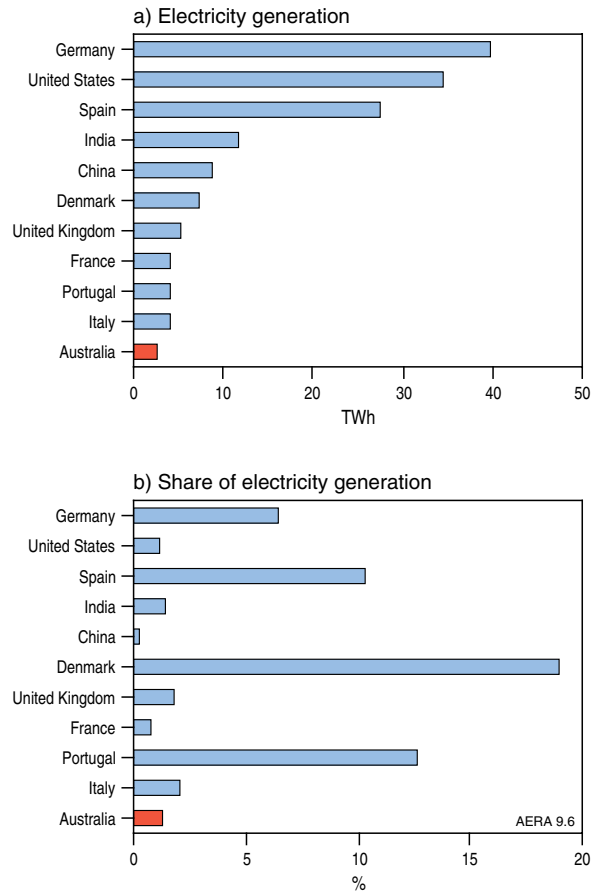


Figure 9.6 Wind electricity generation, major countries, 2007

Source: IEA 2009a

Table 9.2 Installed capacity in major wind electricity generating countries, 2008

Country	Installed capacity GW	Share of world %
1. United States	25.2	21
2. Germany	23.9	20
3. Spain	16.8	14
4. China	12.2	10
5. India	9.6	8
6. Italy	3.7	3
7. France	3.4	3
8. United Kingdom	3.2	3
9. Denmark	3.2	3
10. Portugal	2.9	2
14. Australia	1.3	1
World	121.5	100

Source: GWEC 2009

and India (10 GW). Together these five countries accounted for more than 72 per cent of global installed capacity. The fastest growing region since 2006 has been Asia, accounting for nearly one third of newly installed wind capacity in 2008 (but only 12 per cent of production in 2007).

### World wind energy market outlook

Government policies will be a major contributing factor to the future development of the industry. Renewable energy targets, for example, provide economic incentives to invest in least cost sources of renewable energy resources. Wind energy is likely to become more important in the fuel mix, because wind energy technologies have been demonstrated to be commercially viable and there is still significant development potential for wind resources.

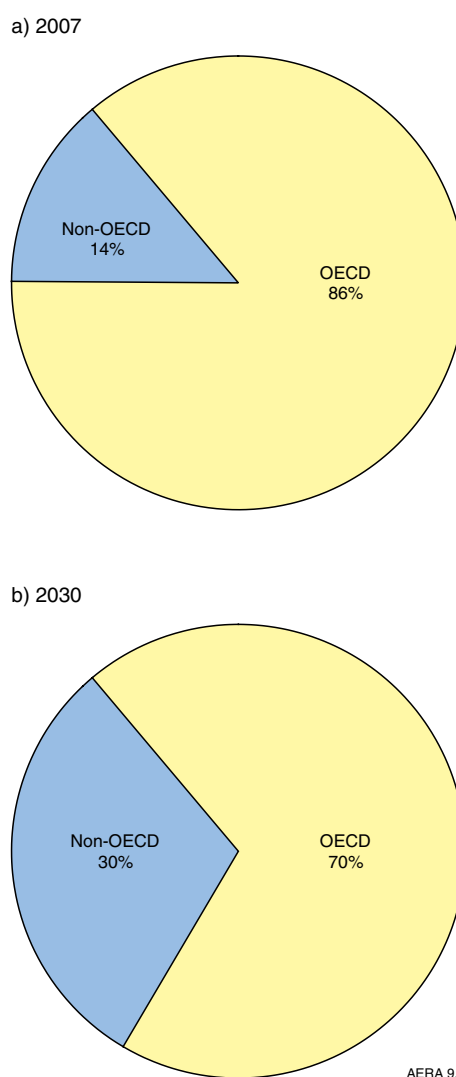
The rapid improvement in wind turbine efficiency and grid integration technology over the past decade is expected to continue, adding to the overall efficiency of the industry. Reducing the cost of wind energy generation, through lower manufacturing costs and economic gains from larger operations, may also enhance the competitiveness of the industry.

According to the IEA (2009b), the global wind energy industry is projected to continue to grow strongly throughout the period to 2030, increasing its share of electricity generation in many countries. In the IEA reference case projections, world electricity generation from wind energy is projected to increase at an average annual rate of 9.9 per cent between 2007 and 2030 (table 9.3). As a result, the share of wind energy in total electricity generation is projected to increase sharply from 0.9 per cent in 2007 to 4.5 per cent in 2030.

OECD countries are expected to continue to be the main wind energy producers over the outlook period. In the OECD region, the share of wind

energy in total electricity generation is projected to rise from 1.4 per cent in 2007 to 8.1 per cent in 2030. Wind energy use is also projected to rise strongly in non-OECD countries – by 2030, non-OECD countries are projected to account for 30 per cent of world wind electricity generation (figure 9.7).

In the IEA's 450 ppm climate change policy scenario (stabilising the concentration of atmospheric greenhouse gases at 450 parts per million), the economic incentives to invest in clean renewable energy sources are considerably greater than those of the reference case. As a result, the share of wind energy in world electricity generation is projected to increase to 9.3 per cent in 2030 (more than double the share in the reference case). In the OECD region, the wind energy share is projected to increase to 12.8 per cent in 2030 under this scenario.



**Table 9.3** IEA reference case projections for world electricity generation from wind energy

	unit	2007	2030
<b>OECD</b>	TWh	150	1068
Share of total	%	1.4	8.1
Average annual growth, 2007–2030	%	-	8.9
<b>Non-OECD</b>	TWh	24	468
Share of total	%	0.3	2.2
Average annual growth, 2007–2030	%	-	13.8
<b>World</b>	TWh	173	1535
Share of total	%	0.9	4.5
Average annual growth, 2007–2030	%	-	9.9

Source: IEA 2009b

**Figure 9.7** IEA reference case projections for wind energy in the OECD and non-OECD regions, 2007 and 2030

Source: IEA 2009b

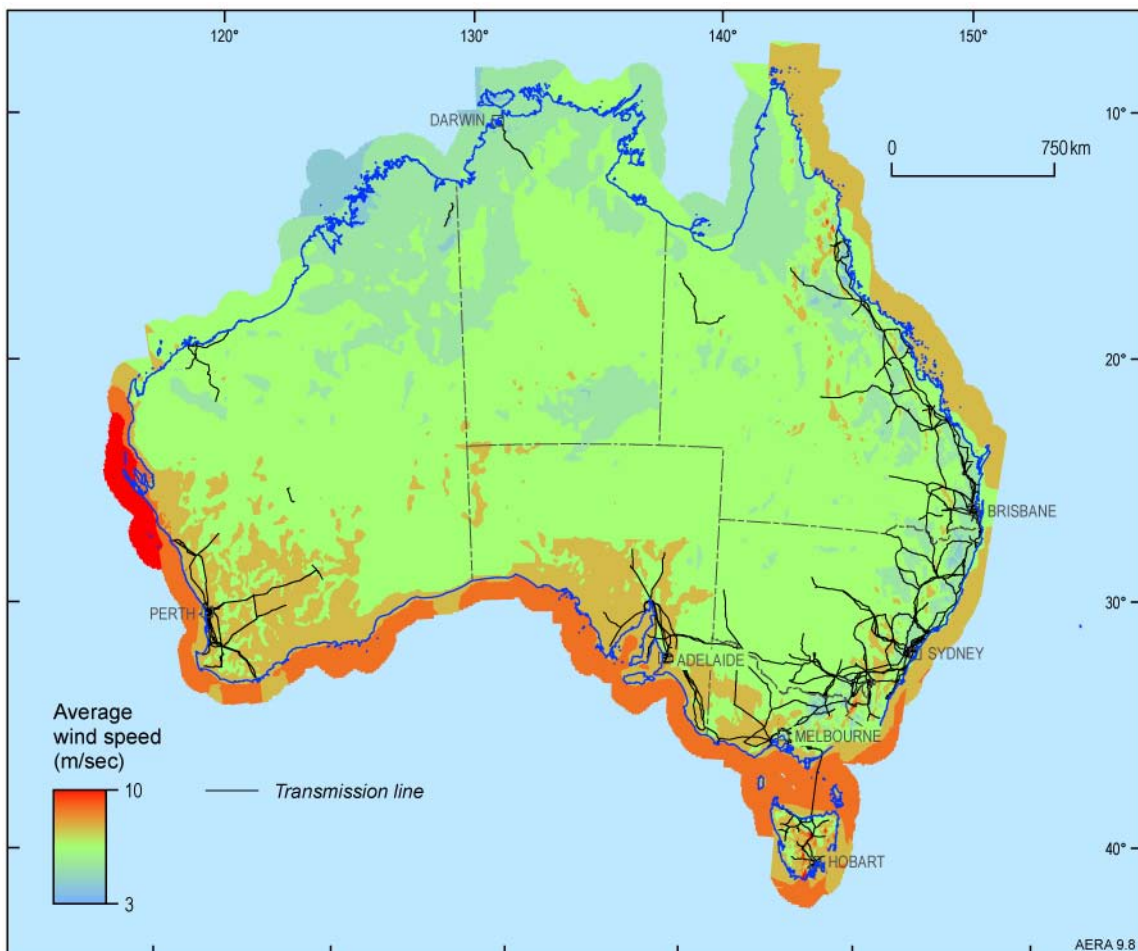
## 9.3 Australia's wind energy resources and market

### 9.3.1 Wind energy resources

Australia has some of the best wind resources in the world. Australia's wind energy resources are located mainly in the southern parts of the continent (which lie in the path of the westerly wind flow known as the 'roaring 40s') and reach a maximum around Bass Strait (figure 9.8). The largest wind resource is generated by the passage of low pressure and associated frontal systems whose northerly extent and influence depends on the size of the frontal system. Winds in northern Australia are predominantly generated by the monsoon and trade wind systems. Large-scale topography such as the Great Dividing Range in eastern Australia exert significant steering effects on the winds, channelling them through major valleys or deflecting or blocking them from other areas (Coppin et al. 2003). Deflection of weaker fronts from frontal refraction around the ranges of the Divide in south eastern Australia creates winds with a southerly component ('southerly busters') along the east coast.

In addition to the refractions by topography and heat lows over northern Australia, other major factors influencing wind resources are seasonal and diurnal variation in wind speed. Winds are strongest in winter and spring in western and southern Australia but the monthly behaviour differs from region to region. Variations in average monthly wind speed of up to 15–20 per cent over the long term annual average are not uncommon. There may be similar daily variations at individual locations, with increased wind speeds in the afternoon (Coppin et al. 2003).

Meso-scale maps show that Australia's greatest wind potential lies in the coastal regions of western, south-western, southern and south-eastern Australia (areas shown in orange to red colours in figure 9.8 where average wind speeds typically exceed 6.5 m/s). Coastal regions with high wind resources (wind speeds above 7.5 m/s) include the west coast south of Shark Bay to Cape Leeuwin, along the Great Australian Bight and the Eyre Peninsula in South Australia, to western Victoria and the west coast of Tasmania (figure 9.8). Good wind resources extend hundreds of kilometres inland and many of Australia's wind farms (current and planned) are located some distance from the coast. Inland regions



**Figure 9.8** Predicted average wind speed at a height of 80 metres

**Source:** Windlab Systems Pty Ltd, DEWHA Renewable Energy Atlas (wind map data); Geoscience Australia



of Western Australia, South Australia and western Victoria all have good wind resources. Areas with high wind potential also lie along the higher exposed parts of the Great Dividing Range in south-eastern Australia, such as the Southern Highlands and New England areas.

The New South Wales Wind Atlas (Sustainable Energy Development Authority, NSW 2002) shows that the areas with the highest wind energy potential lie along the higher exposed parts of the Great Dividing Range and very close to the coast except where there is significant local sheltering by the escarpment. The best sites result from a combination of elevation, local topography and orientation to the prevailing wind. Significantly, the map shows that some inland sites have average wind speeds comparable with those in coastal areas of southern Australia.

The Victorian Wind Atlas (Sustainable Energy Authority Victoria 2003), shows a modelled average wind speed of 6.5 m/s across the state with the highest average wind speeds (> 7 m/s) found in coastal, central and alpine regions of Victoria (figure 9.8). The atlas also presents modelled average wind speed data in relation to land title (national parks, other public land and freehold land), land use and proximity to the electricity network. Effective wind resources are defined as those located within a commercially viable distance from the electricity network. The atlas delineates corridors within 10 and 30 km of the network. It presents wind resource maps for each of the local government areas in relation to the electricity network according to land title.

Local topography and other variability in the local terrain such as surface roughness exert a major influence on wind speed and wind variability. Wind speed varies with height and with the shape and roughness of the terrain. Wind speed decreases with an increasingly rough surface cover, but can be accelerated over steep hills, reaching a maximum at the crest and then separating into zones of turbulent air flow. There are also thermal effects and funnelling which need to be considered when assessing wind resources. All of these effects impact on capacity factors (Coppin et al. 2003; ESIPC 2005). Australia's high capacity factors reflect the large development potential.

Because of these factors meso-scale maps such as figure 9.8 do not account for fine-scale topographical accelerations of the flow. In particular, the effect of any topographical feature smaller than 3 km is unlikely to be accounted for. In mountainous country, topographical accelerations (and decelerations) because of these finer scale features commonly exceed 20 per cent. As such, these maps are useful only for preliminary selection of sites: detailed assessment of wind energy resources for potential wind farm location sites requires integration of high

quality monitoring measurements with a micro-scale model of wind flow incorporating the effects of topography and terrain roughness.

### 9.3.2 Wind energy market

The wind energy market in Australia is growing at a rapid pace, driven by an increasing emphasis on cleaner energy sources and government policies encouraging its uptake. The wind energy industry has been the fastest growing renewable energy source, largely because it is a proven technology, and has relatively low operating costs and environmental impact.

#### Primary energy consumption

In 2007–08, wind energy accounted for only 0.2 per cent of primary energy consumption (table 9.1). However, wind is the fastest growing energy source in Australia, increasing at an average annual rate of 69.5 per cent between 1999–00 and 2007–08.

#### Electricity generation

In Australia, wind energy was first utilised for electricity generation in 1994 and the industry has expanded rapidly in recent years (figure 9.9). Australia's wind electricity generation was 3.9 TWh (14.2 PJ) in 2007–08, accounting for 1.5 per cent of total electricity output in Australia.

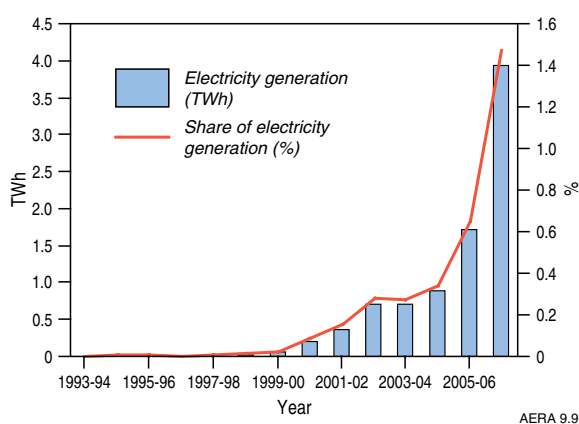


Figure 9.9 Australia's wind electricity generation

Source: IEA 2009; ABARE 2009a

#### Installed electricity generation capacity

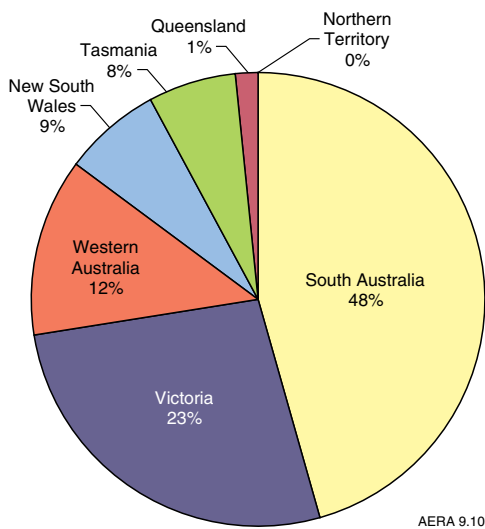
In September 2009 there were 85 wind farms in Australia with a combined installed capacity of 1.7 GW (table 9.4). The majority of these power stations were located in South Australia (48 per cent), Victoria (23 per cent) and Western Australia (12 per cent) (figure 9.10). Information on recently developed wind energy projects is provided in box 9.2.

The size of wind farms is increasing, as companies with capacity to install large farms take advantage of economies of scale and capitalise on sites with high wind potential. Australia's largest wind farm is the Waubra wind farm in Victoria (192 MW), which was

**Table 9.4** Australia's wind energy industry: number of farms and installed capacity, by state, 2009

State/Territory	Farms no.	Installed capacity MW	Share of total capacity %
South Australia	19	810.9	47.6
Victoria	19	383.9	22.5
Western Australia	19	202.7	11.9
New South Wales	9	149.0	8.7
Tasmania	7	143.9	8.4
Queensland	8	12.5	0.7
Northern Territory	4	0.1	0.0
<b>Australia</b>	<b>85</b>	<b>1703</b>	<b>100.0</b>

Source: Geoscience Australia 2009; ABARE 2009b



**Figure 9.10** Installed wind energy capacity, by state, 2009

Source: Geoscience Australia 2009

commissioned in mid 2009, followed by Lake Bonney in South Australia (159 MW). However, wind farms larger than 200 MW and up to 1000 MW are planned or under construction. More detailed information on project developments is provided in section 9.4.2.

## 9.4 Outlook to 2030 for Australia's wind energy resources and market

Australia accounts for only a small share of world wind energy production (an estimated 2 per cent in 2008); however, it grew at a faster rate (69 per cent) than average between 1999–00 and 2007–08. While wind currently accounts for only 1.5 per cent of Australia's electricity generation its share is likely to increase, driven substantially by government policies such as the Australian Government's Renewable Energy Target (RET) and the fact that wind energy is a proven renewable energy technology with extremely low greenhouse gas emissions.

By 2029–30 wind energy is projected to provide about 12 per cent of Australia's electricity (ABARE 2010).

### 9.4.1 Key factors influencing the future development of Australia's wind resources

Worldwide, wind energy is the fastest growing form of electricity generation and is set to play an increasingly important role in the energy mix, globally as well as in Australia. It is a proven and mature technology and the output of both individual turbines and wind farms has increased significantly in the past five years. The wind energy market has reached a mature stage in some energy markets, such as in western Europe, because it is already cost competitive with other forms of electricity generation.

The expansion of wind energy in Australia is likely to be enhanced by government policies favouring low emissions, such as the RET and emissions reduction targets and the increasing cost competitiveness of wind energy. The RET will help drive the growth of renewable energy sources in the period to 2020. After 2020 the proposed emissions reduction target carbon price is projected to rise to levels that continue to drive the growth of renewable energy. Wind energy is likely to particularly benefit.

Wind is generally the most cost competitive renewable source of electricity generation behind hydro. However, it has significantly more growth potential because of the greater level of as yet unutilised resources. Its cost competitiveness will be enhanced by a reduction in the cost of turbines, particularly through low cost, high volume manufacturing in countries such as India and China, and to a lesser extent by further efficiency gains through turbine technology development.

Factors that may limit development of wind energy on a localised basis are a lack of electricity transmission infrastructure to access remote wind resources, and the intermittency and variability of wind energy. The variability of wind energy can create difficulties in integration into the electricity system where supply

must balance demand in real time to maintain system stability and reliability. This becomes more of a problem as the amount of wind energy incorporated into the grid increases and can become significant in a localised context. However, at the levels of wind energy penetration projected, these issues should be effectively managed by greater geographic spread of wind resources, improvements to the response capabilities of the grid through improved forecasting, continued use of conventional fuels for base load electricity generation and increased use of gas turbines in peaking generation.

### Wind energy – an increasingly cost-competitive mature low emissions renewable energy source

The rapid expansion of wind energy over the past decade is the outcome of international research and development that has resulted in major improvements in wind turbine technology.

The most significant technological change in wind turbines has been substantial increases in the size and height of the rotor, driven by the desire to access higher wind speeds (wind speed generally increases with height above the ground) and thereby increase the energy extracted. The size of the rotor is

determined by the maximum aerodynamic efficiency, which is adjusted to keep the tip speed under control, and so minimise noise concerns, and to spill wind when the turbine reaches maximum output.

The size and output of wind turbine rotors has doubled over the past fifteen years (figure 9.19). For example, Australia's first large-scale grid-connected wind farm (at Crookwell, New South Wales) in 1998 comprised eight 600 kW wind turbines each with a rotor diameter of 44 metres for a combined energy output of 4.8 MW. Today most onshore wind turbine generators have a capacity of 1.5 to 2 MW; the largest wind turbines – designed for offshore sites – have a capacity of 5 MW and rotor blades up to 60 m long (120 m rotor diameter). The recently commissioned Capital Wind Farm (near Goulburn in New South Wales) comprises 67 wind turbines, each with a rating of 2.1 MW and rotor diameter of 88 metres, resulting in total installed capacity of 141 MW.

Efficiency gains through onshore turbine technology are now slowing, and further increases in cost competitiveness will be driven by reducing manufacturing costs. This is being achieved primarily through a move to low cost, high volume turbine production.

#### BOX 9.2 WIND PROJECTS RECENTLY DEVELOPED

Since 2005, there have been some 17 wind energy projects completed in Australia, with a combined generation capacity of around 1475 MW. Of these, seven were developed in South Australia, five in Victoria, two in Western Australia, two in New South Wales and one in Tasmania. The largest project completed was the Waubra wind farm in Victoria, completed in 2009 by Acciona Energy and ANZ Energy Infrastructure Trust.

**Table 9.5** Wind projects recently developed, as at late 2009

Project	Company	State	Start up	Capacity
Cape Bridgewater	Pacific Hydro	VIC	2008	58 MW
Capital Wind Farm	Renewable Power Ventures	NSW	2009	141 MW
Cathedral Rocks	Roaring40s/Hydro Tasmania & Acciona Energy	SA	2005	66 MW
Cullerin Range Wind Farm	Origin Energy	NSW	2009	30 MW
Emu Downs	Transfield Services Infrastructure Ltd & Griffin Energy	WA	2006	79.2 MW
Hallett 1	AGL	SA	2007	94.5 MW
Lake Bonney 1	Babcock and Brown Wind Partners	SA	2005	80.5 MW
Lake Bonney 2	Babcock and Brown Wind Partners	SA	2008	159 MW
Mount Millar	Transfield Services Infrastructure Ltd	SA	2006	70 MW
Portland stage 3	Pacific Hydro	VIC	2009	44 MW
Snowtown	Wind Prospect and Trust Power	SA	2007	98.7 MW
Walkaway	Babcock and Brown Wind Partners/Alinta Ltd	WA	2005	90 MW
Wattle Point	ANZ Energy Infrastructure Trust/Wind Farm Developments	SA	2005	91 MW
Waubra	Acciona Energia/ANZ Energy Infrastructure Trust	VIC	2009	192 MW
Wonthaggi	Wind Power Pty Ltd	VIC	2005	12 MW
Woolnorth	Roaring40s/Hydro Tasmania	TAS	2007	140.25 MW
Yambuk	Pacific Hydro Ltd	VIC	2007	30 MW

Source: Geoscience Australia 2009

### Cost of development

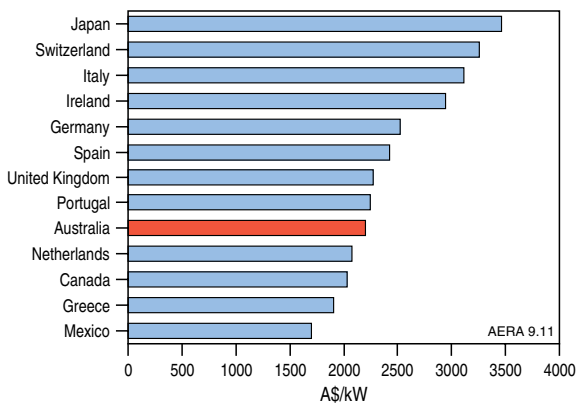
The costs specific to developing a new wind farm will vary across projects and locations. They will be influenced by a number of factors such as:

- The cost of turbines;
- Proximity to existing infrastructure;
- Ease of grid integration;
- Whether the development is onshore or offshore;
- The life of the project;
- Government policies and regulations;
- Environmental impact; and
- Community support.

These factors influence the spread of development costs across different countries (figure 9.11).

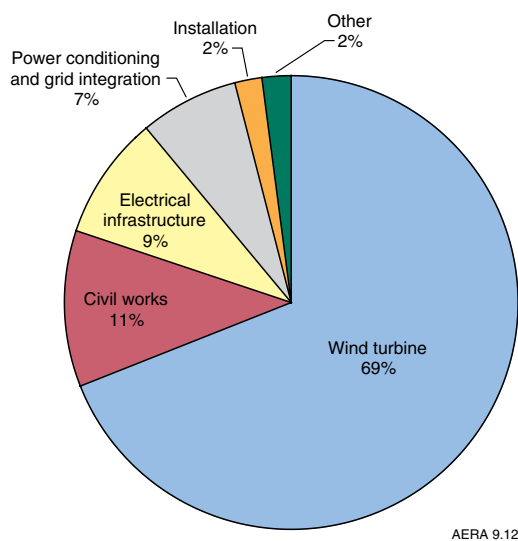
### Lifecycle cost structure

The development of wind energy is relatively capital intensive compared with many other energy sources, estimated to typically comprise between 70 per



**Figure 9.11** Estimated average wind energy project cost, 2007

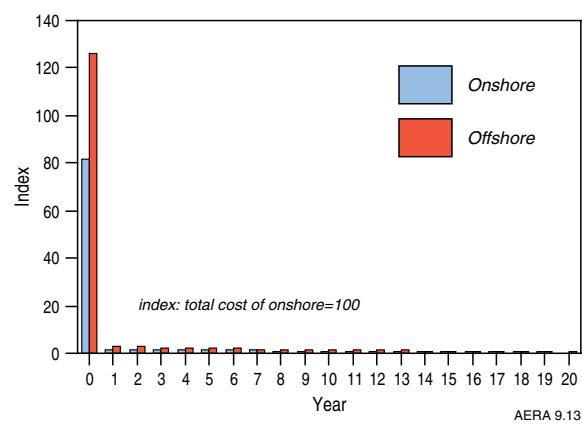
Source: IEA 2008; ABARE 2009b



**Figure 9.12** Capital costs of a typical wind farm

Source: Mathew 2006

cent and 80 per cent of a project's lifetime costs (Blanco 2009, Dale et al. 2004). This is primarily because of the high cost of turbines (figure 9.12) and grid integration infrastructure relative to the low variable costs. The only variable costs are operation and maintenance costs, as the resource used in electricity generation (i.e. wind) is free. Individual turbines can cost up to \$3 million. A tightness in supply and high metal prices led to substantial increases in the cost of turbines in the period 2004–08 but prices for 2010 delivery have eased (Beck and Haarmeyer 2009). Figure 9.13 shows a schematic life-cycle cost structure of a typical wind farm, as estimated by Dale et al. (2004).



**Figure 9.13** Lifecycle costs of a typical wind farm

Source: Dale et al. 2004

A wind farm's revenue stream at its most basic level is the product of the amount and price of electricity sold to the grid. Higher income streams are favoured by a higher electricity price and by larger wind farms with larger turbines (and hence greater capacity). Consequently, countries with relatively more highly developed wind energy industries typically have a combination of good wind conditions and high electricity prices. Direct subsidies and other clean energy initiatives may further influence the uptake of wind energy.

### Economies of scale

At the end of 2008, small wind farms (less than 10 MW capacity) comprised 70 per cent of operating wind farms in Australia, but accounted for less than 2 per cent of Australia's wind energy capacity (figure 9.14). On the other hand, large wind farms (greater than 100 MW capacity) comprised 6 per cent of operating wind farms but accounted for around 38 per cent of Australia's wind generating capacity. Medium sized wind farms (10–100 MW capacity) accounted for the majority of wind energy capacity in Australia, around 60 per cent. Large operations account for a much greater proportion of proposed operations (tables 9.7 and 9.8; ABARE 2009b).

The increasingly large size of wind farms reflects the economies of scale to be gained through larger operations. Heavy utilisation of sites with high wind potential and consolidation of generating technology will significantly reduce grid integration costs and maximise the economic gains from wind energy. The economies of scale can be seen by the lower cost per kWh of larger wind farms (figure 9.15). In addition, larger firms are more able to cover the considerable fixed costs of setting up larger wind farms, which is reflected in a trend toward industry consolidation.

Past barriers to the development of larger installations have been the large up-front capital costs and the associated uncertainty about achieving secure contracts for the electricity generated. However, this barrier is declining in importance because of the increasing demand for low emission renewable energy. As returns to investments are proven and become more secure, larger investments are emerging.

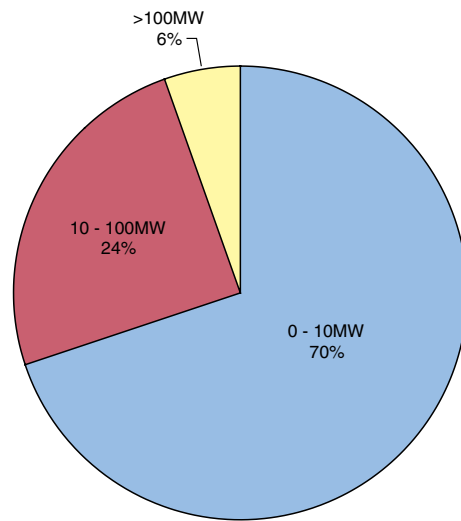
**Cost competitiveness**

On a levelised cost of technology basis (including capital, operating, fuel, and maintenance costs, and capacity factor) wind energy compares favourably with traditional sources of electricity generation, such as coal, oil, gas, nuclear and biomass (figures 2.18, 2.19, Chapter 2). Moreover, its uptake will be favoured by the RET. Lower manufacturing costs together with improvements in turbine efficiency and performance, and optimised use of wind sensing equipment are expected to decrease the cost of wind technology in the future.

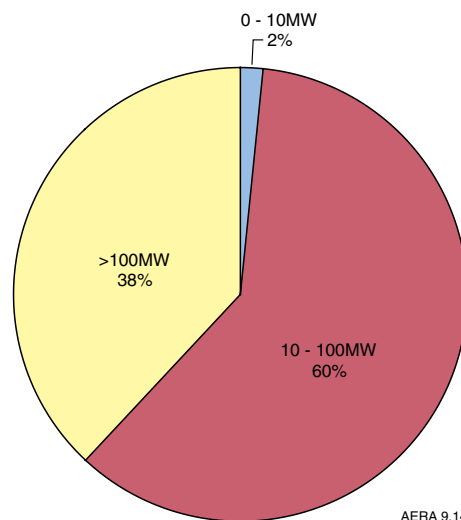
**Time to develop**

The development process after feasibility has been ascertained is relatively simple, comprising an approval stage and a building stage. The length of the approval stage can vary widely, depending on the relevant authorities' requirements and the complexity of the approval process. Construction time varies depending on a number of factors but is short compared with many other forms of electricity generation. For example, the 192 MW Waubra wind farm began construction in November 2006 and was completed in May 2009 – a total of about 2.5 years. Construction of smaller projects can be significantly quicker: the 30 MW Cullerin Range Wind Farm took 1 year, after commencing in June 2008 it was completed in June 2009. Because of additional foundation and grid integration requirements, installation of offshore wind farms involves longer building times. Remoteness and complexity of terrain will also affect the building time. Conversely, one advantage of wind energy is that, compared with many other renewable technologies, it is a proven technology that is relatively straightforward to build and commission.

a) Number of installed wind farms, by farm size



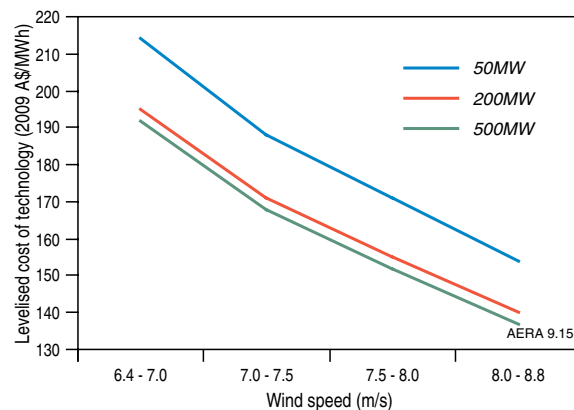
b) Total installed capacity, by farm size



AERA 9.14

**Figure 9.14** Current wind energy installations in Australia, by farm size

**Source:** Geoscience Australia 2009



AERA 9.15

**Figure 9.15** Wind levelised cost of technology, by farm size

**Note:** This EPRI technology status data enables the comparison of technologies at different levels of maturity. It should not be used to forecast market and investment outcomes.

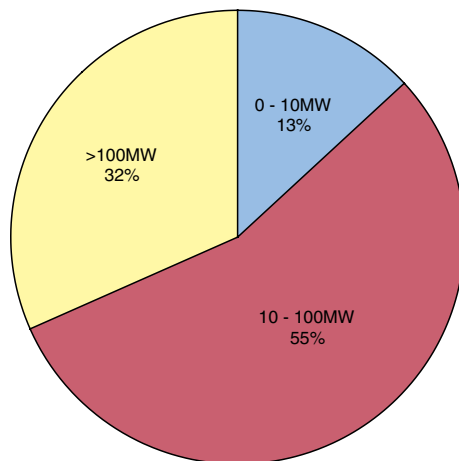
**Source:** EPRI technology status data



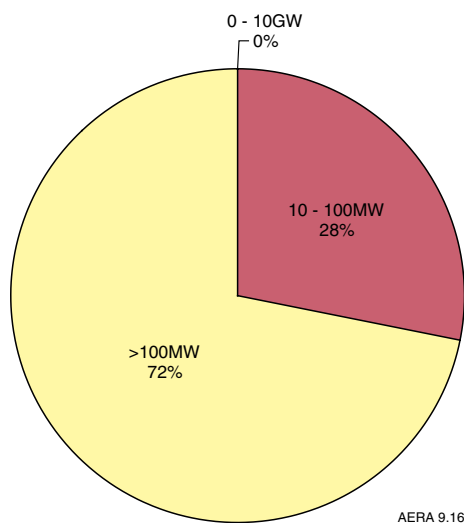
## Policy environment

The current and prospective policy environments within which a wind farm is operating are central to the effectiveness and competitiveness with which it operates. Direct support through subsidisation or favourable tax policies (as in some countries), or indirect support for renewables from costs imposed on greenhouse gas emissions will enhance the competitiveness of wind energy and other renewables sources of energy. The operation of wind turbines produces no carbon dioxide emissions, and emissions involved in the development stage are modest by comparison with electricity generation from other sources. In Australia growth of wind energy is favoured by the Renewable Energy Target and proposed reductions in carbon emissions.

a) Number of proposed wind farms, by farm size



b) Total proposed capacity, by farm size



**Figure 9.16** Proposed wind energy installations by farm size

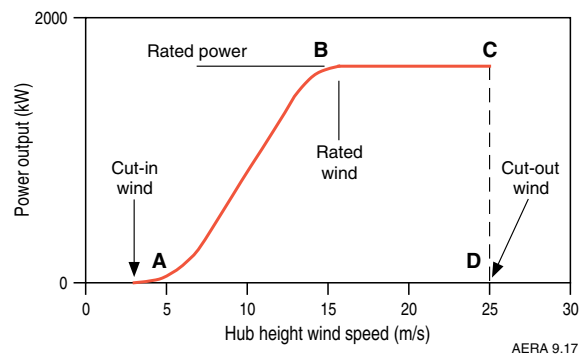
Source: Geoscience Australia 2009

## Grid integration – managing an intermittent source of energy

Wind is a highly variable resource and so, therefore, is wind energy production. The high ramp rate of wind energy production is an associated and equally important characteristic, particularly in integrating the electricity produced into the electricity grid. Because wind energy increases more than proportionately with wind speed, electricity generation from wind energy can increase very rapidly (point A to B in figure 9.17). Similarly, if wind speeds exceed the turbine rating the turbine shuts down and electricity generation can drop from maximum to zero very quickly (point C to D). The variability and intermittency of wind energy needs to be matched by other fast response electricity generation capacity, or demand response. In practice this is met by complementary electricity generation capacity, typically hydro energy or increasingly gas.

Because of wind energy's inherent supply intermittency and variability, with electricity generation fluctuating according to the prevailing weather conditions, season and time of day, the penetration of wind energy in the Australian market will depend in part on improved grid management practice. A range of initiatives is being taken to enhance grid responsiveness (AER 2009). An important factor in this process is the installation of sufficient capacity to effectively manage increased supply volatility.

Grids dominated by electricity generated from conventional fuels can face difficulties in dealing with renewables other than hydro and tend to be limited to 10–20 per cent penetration by power quality issues, installed capacity and current grid management techniques. Given that wind energy accounted for only 1.5 per cent of Australia's total electricity generation in 2007–08, however, this has only been an issue at a localised level, where wind energy penetration can be much higher. Wind accounts for around only 4 per cent of registered capacity in the National Electricity Market (NEM) but has a significantly higher share in South Australia at 20 per cent (AER 2009).



**Figure 9.17** Power curve and key concepts for a typical wind turbine

Source: Ackermann 2005

The limits for a particular grid are determined by a number of factors, including the size and nature of existing connected generating plants and the capacity for storage or demand management. In grids with heavy fossil fuel reliance and sufficient hydro for balancing, wind energy penetrations of less than 10 per cent are manageable; penetration levels above 20 per cent may require system and operational changes. Gas-fired electricity generation using gas turbines, as an alternative fast response energy source, is likely to play an increasingly important role as the proportion of wind and other intermittent renewable energy used increases (AER 2009). Augmentation of the grid will also be required (AEMO 2009).

Accurate and timely wind forecasting using a range of new techniques and real-time wind and generation modelling will also enhance wind energy penetration and grid integration (Krohn et al. 2009). The Wind Energy Forecasting Capability (WEFC) system will produce more accurate forecasts of wind electricity generation over a range of forecast timeframes that can be used by the Australian Energy Market Operator (AEMO), wind farms and other market participants to better appreciate and manage the balance between supply and demand and the interaction between baseload and peakload generation.

In essence, an 'intelligence' layer is being added to the core transmission and distribution systems. Research into Smart Grids – automated electricity systems that are able to automatically respond to changes in supply from renewables and fluctuations in electricity demand – is being conducted in a number of countries, including Australia. Smart grids allow real-time management and operation of the network infrastructure. The Australian Government has committed \$100 million to trial smart grid technologies.

Various other experimental technologies are being explored, including storage technologies and hybrid energy installations. The Australian Government's Advanced Electricity Storage Technologies program is supporting the development and demonstration of efficient electricity storage technologies for use with variable renewable generation sources, such as wind, in order to increase the ability of renewable energy-based electricity generation to contribute to Australia's electricity supply system. The advanced storage technologies include, but are not limited to, electro-mechanical, chemical and thermal battery systems.

A report by the Australian Energy Market Commission (AEMC 2009) recognised the need for increased flexibility and further expansion of the electricity transmission grid into new areas not previously connected to allow for an expanded role of renewable energy sources in the future. It suggests greater access to renewable resources clustered in remote geographic areas through development of connection

'hubs' or scale efficient network extensions. It also noted that expansion of gas-fired generation to back up renewable generation, such as wind, would place a greater demand for gas supply and pipeline infrastructure and lead to a greater convergence of the gas and electricity markets.

With the possible exception of localised areas with significantly higher than average wind resource (such as in South Australia and Western Australia), limits which place economic grid connection at risk are not likely to be reached in the outlook period.

### Offshore wind energy developments

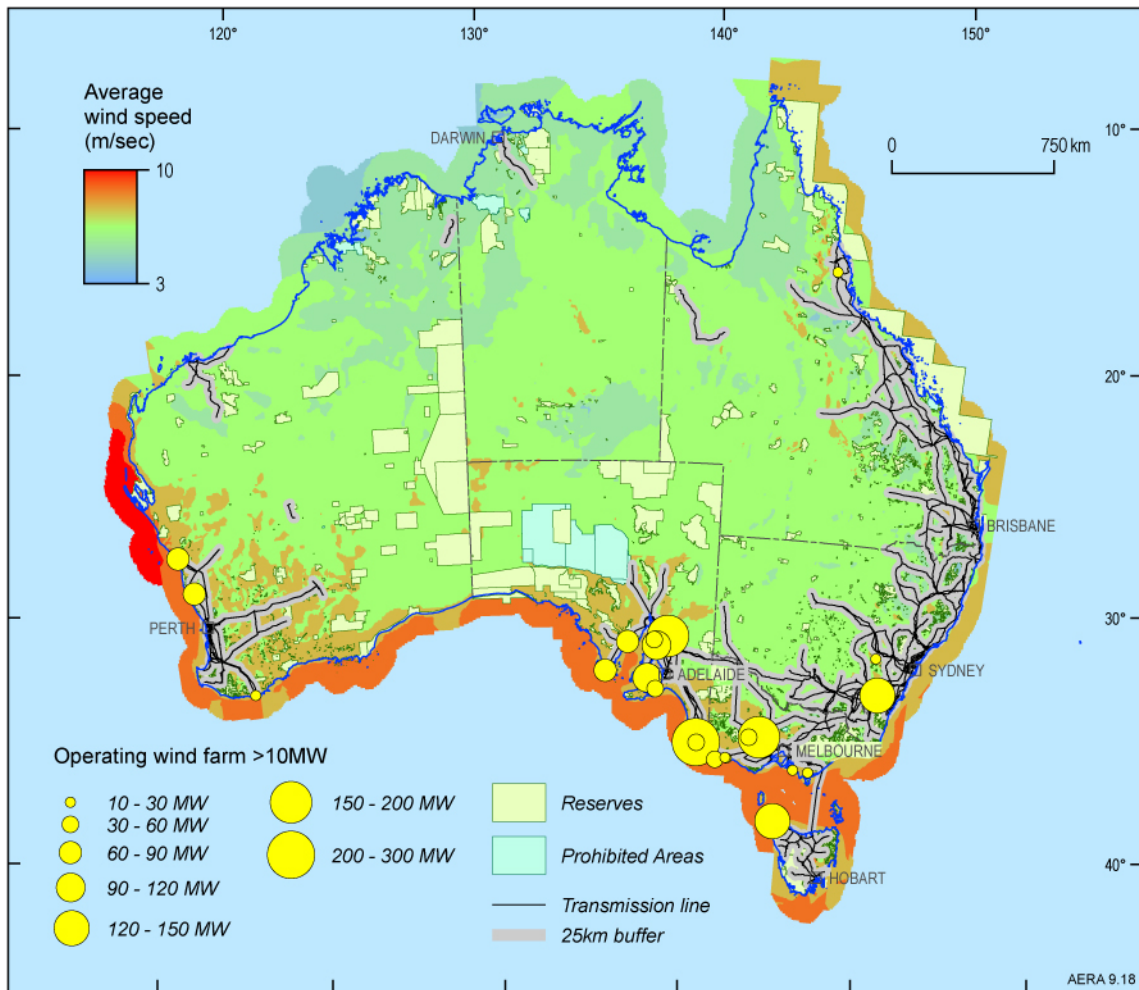
Because sites with the highest wind energy potential tend to be developed first, newer wind farms are likely to be sited in areas with progressively lower capacity factors. There has been some evidence of this in Europe, where land limitations have resulted in a declining average capacity factor. It has provided significant incentive to develop offshore sites.

Currently, development of wind farms offshore are limited by the high costs of offshore foundations and high costs of grid connection. Offshore locations also considerably raise the costs of operation and maintenance. However, because of substantially higher wind velocities, and therefore wind energy potential, compared with onshore sites, research and development into new technologies to increase the competitiveness of offshore wind farms is continuing. Offshore wind turbines are typically larger than those onshore to balance the increased costs of offshore marine foundations and submarine electric cables. Currently commercial, offshore wind farms are installed at shallow water depths (up to 50 m) with foundations fixed to the seabed but large scale floating turbines using ballast tied to the sea floor with cables are being tested. If successful this will allow offshore deployment in water more than 100 m deep.

Offshore sites are more important in countries with significant land access limitations, most notably in western Europe. Because Australia has sufficient onshore sites with high potential, offshore sites are unlikely to be developed in the short term. Australia's offshore sites are likely to be high cost due to ocean depth.

### Electricity transmission infrastructure – a potential long term constraint

Proximity to a major energy load centre is an important element in a wind farm's economic viability, because the costs of transmission infrastructure and energy losses in transmission increase with distance from the grid. Reflecting this, wind farm developments to date have mostly been in close proximity (less than 30 km) to the grid (figure 9.18). As the size of wind farms has increased, so has the distance from the grid, with some proposed up to 100 km from the grid. The increased costs



**Figure 9.18** Wind energy resources in relation to reserved land and prohibited areas and the transmission grid. A 25 km buffer zone is shown around the electricity transmission grid

**Source:** Windlab Systems Pty Ltd, DEWHA Renewable Energy Atlas (wind map data); Geoscience Australia

and transmission losses involved impact significantly on evaluation of the cost competitiveness of the wind farm overall, and are a key factor in project evaluation.

Development of remote wind energy resources will depend on extensions to the existing transmission grid. This is demonstrated by the significant reduction of the area with good wind resources (7 m/s and greater shown in figure 9.18) from about 600 000 km<sup>2</sup> to about 3300 km<sup>2</sup> when constrained to within 100 km of the existing electricity transmission grid (66 kV and greater). The actual area available for wind farm development is significantly less than this because of other limitations such as other competing land uses, forest cover, access, and local planning and zoning laws (see for example, SEAV 2003).

### Social and environmental issues – potential local constraints

Although the low level of environmental impact has been a major driver of wind farm development, there are social and environmental aspects of its operation which have attracted criticism. The most common

criticisms of wind farm developments are on the basis of aesthetics, low frequency noise pollution and impacts on local bird populations.

Modern wind turbines can generate noise across the frequency range of human hearing (20 to 20 000 Hertz) and extending to low frequency (in the range of 10 to 200 Hertz) and even infrasound (in the range of 20 Hz down to 0.001 Hz) levels, below the detection limit of the human ear. Concerns have been expressed that low frequency noise emitted by wind turbines can cause illness to those living in close proximity to wind turbines. However, research has shown that the levels of low frequency noise and infrasound emitted by modern wind turbines are below accepted thresholds (British Wind Energy Association 2005). There is a detailed approval process for every wind farm development which includes rigorous noise assessment. Compliance is required with relevant state Environmental Protection Agency guidelines and regulation.

Certified Wind Farms Australia (CWFA) was instituted to provide an auditable social and environmental

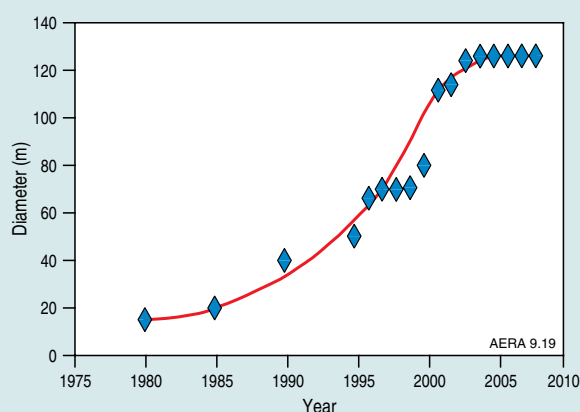
**BOX 9.3 THE WIND TURBINE – A MAJOR TECHNOLOGICAL DEVELOPMENT**

The majority of wind turbines are based on the Danish three blade design. This design differs from traditional windmills as the force from high velocity winds could potentially exceed the fatigue levels acceptable for components of the turbine. Therefore, instead of many broad, closely spaced blades, three long narrow blades achieve a balance between wind captured and an ability to manage extreme wind volatility (DWIA 2009).

Wind turbines capture wind energy within the area swept by their blades. The blades in turn drive a generator to produce electricity for export to the grid. The most successful design uses blades which generate 'lift' causing the rotor to turn. Some smaller turbines use 'drag' but they are less efficient. The common lift-style blades have a maximum efficiency of around 59 per cent, within the limits imposed by the designed maximum blade speed. Most modern wind turbines start producing energy at wind speeds of around 4 m/s, reach maximum energy at about 12–14 m/s, and cut out at wind speeds above 25 m/s.

Other considerations of turbine design include spacing between turbines, whether they are oriented upwind or downwind and the use of static or dynamic rotor designs. In each case a trade-off between size, cost, efficiency, aesthetics and a range of other factors is considered in the design of each farm.

Technology development has played an important role in increasing the competitiveness of wind energy in the electricity generation market. The size of wind turbines has reached a plateau after rising exponentially (figure



**Figure 9.19** Increasing size of wind turbines over time

Source: Windfacts 2009

9.19). The energy output increases with the rotor swept area (rotor diameter squared) but the volume of material (cost and mass) increases in proportion to the cube of the rotor diameter (USDOE 2008).

Until now, the additional benefits of size increases have outweighed the additional costs, which have resulted in the size of turbines increasing rapidly. While turbines are expected to continue to get bigger, the additional returns from those size increases are likely to diminish. Research into rotor design and materials is aimed at reducing loads on blades to allow development of larger, lighter rotors and taller towers with higher capacity factors. Wind turbines with capacities up to 7.5 MW are being considered for offshore deployment.

**Table 9.6** Outlook for wind energy in Australia

	unit	2007–08	2029–30
<b>Primary energy consumption<sup>a</sup></b>	PJ	14.2	160
Share of total	%	0.2	2.1
Average annual growth, 2007–08 to 2029–30	%	-	11.6
<b>Electricity generation</b>			
Electricity output	TWh	4	44
Share of total	%	1.5	12.1
Average annual growth, 2007–08 to 2029–30	%	-	11.6

<sup>a</sup> Energy production and primary energy consumption are identical

Source: ABARE 2010

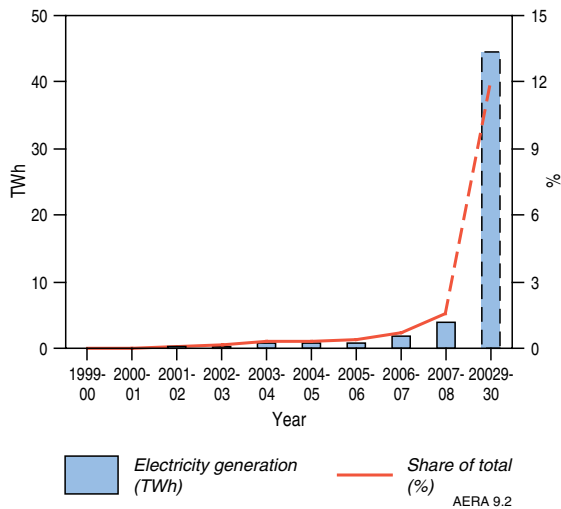
sustainability framework for the wind energy industry. This aims to provide a basis for continual assessment and improvement of best practice within the industry, and a mechanism for assessment of wind farm projects against these benchmarks.

#### 9.4.2 Outlook for wind energy market

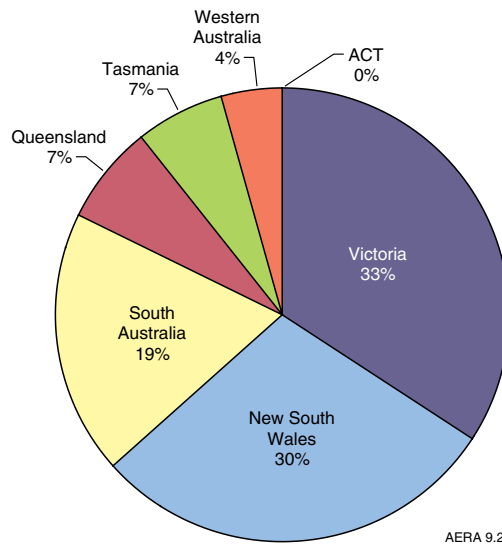
Wind is expected to play an increasingly important role in the energy mix of many countries, including Australia. It will be essential in meeting the RET,

and is expected to underpin a rapidly expanding renewables sector. In the latest ABARE long-term energy projections which are based on the RET and a 5 per cent emissions reduction target, wind energy is projected to generate 44 TWh of electricity in 2029–30, accounting for 12.1 per cent of Australia's electricity generation, and 2.1 per cent of Australia's total primary energy consumption (table 9.6). This represents 12 per cent average annual growth over the period to 2029–30.

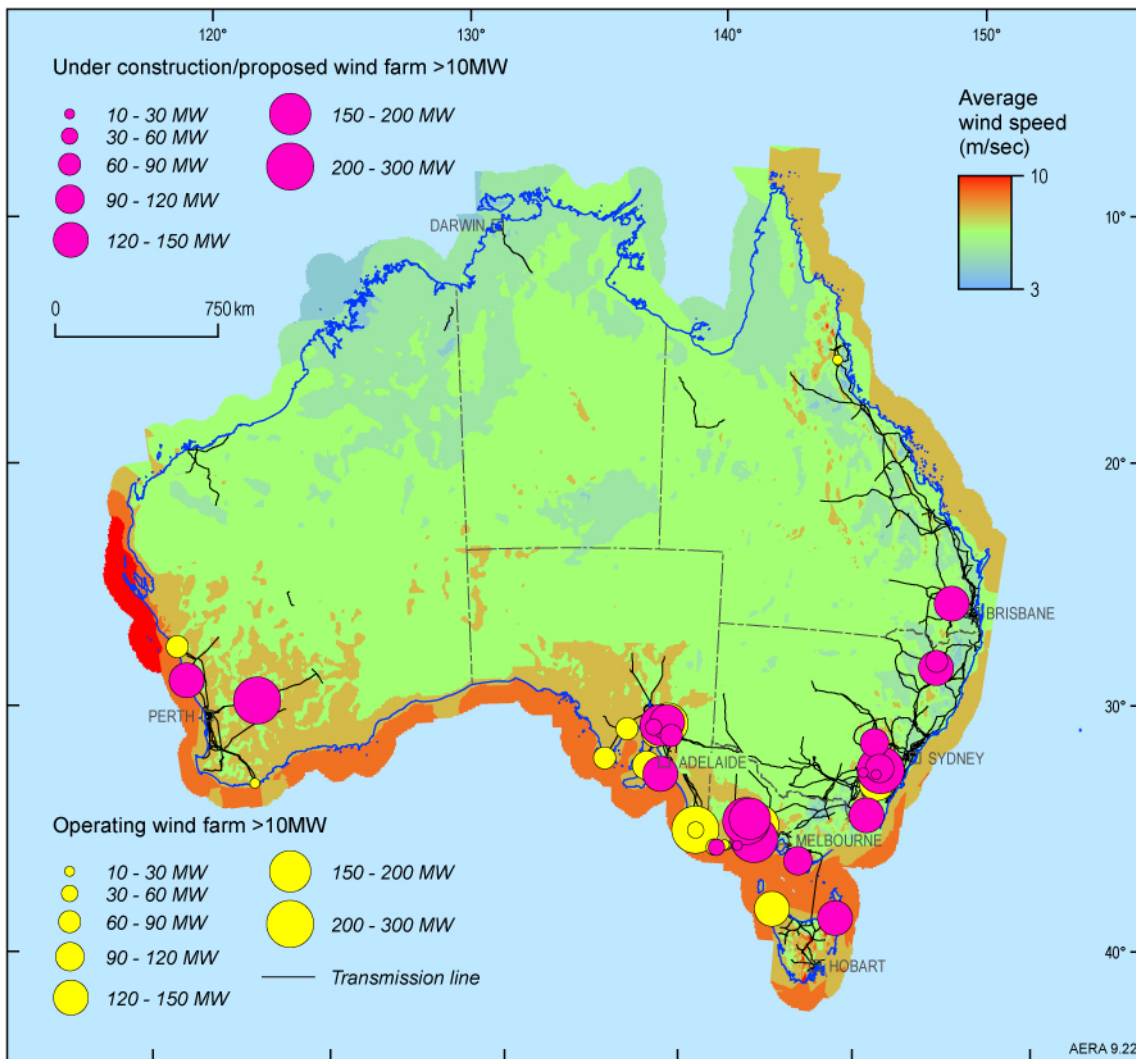




**Figure 9.20** Projected Australian wind energy production and wind share of electricity generation  
**Source:** ABARE 2010



**Figure 9.21** Proposed wind energy capacity by state  
**Source:** ABARE 2009b



**Figure 9.22** Proposed development projects  
**Source:** ABARE 2009b; Windlab Systems Pty Ltd, DEWHA Renewable Energy Atlas (wind map data); Geoscience Australia



Wind energy is projected to be the second fastest growing energy industry after geothermal over the outlook period to 2029–30, reflecting the relatively low base from which it is growing and the relative maturity of the technology compared with other renewable energy sources. It is projected to overtake hydro electricity production within the outlook period, to become the largest renewable source of electricity generation in Australia.

### Proposed development projects

The majority of the planned expansions in wind energy capacity are expected to occur in southern regions of Australia with high wind energy potential. Overall, a further 11.3 GW of wind energy capacity has been proposed, with the bulk of this in Victoria (34 per cent), New South Wales (30 per cent) and South Australia (19 per cent), taking account of both wind energy potential in these areas and constraints imposed by the transmission grid (figure 9.21).

As of October 2009, there were eight wind projects in Australia at an advanced stage of development.

In total, they have a planned capacity of 733 MW, and a combined capital expenditure of \$1.8 billion. Of the eight projects, three have a planned capacity of over 100 MW; the remainder vary between 39 and 92 MW (table 9.7).

Wind projects at a less advanced stage of development had a total of almost 11 GW of additional capacity (table 9.8). Although the development of these projects is not certain, as they are subject to further feasibility and approval processes, it is of particular note that the average capacity is 149 MW, compared with an average capacity of 92 MW for projects at an advanced stage of development. The most significant of these prospective projects is the Silverton wind farm in New South Wales. This is the largest proposed wind farm development, both in terms of additional capacity (1000 MW) and capital expenditure (\$2.2 billion). It is currently planned to be commissioned in 2011. Reflecting high wind potential, the majority of wind energy projects are planned for the south-east region of the country.

**Table 9.7** Projects at an advanced stage of development, as of October 2009

Project	Company	Location	Status	Start up	Capacity	Capital Expenditure
Clements Gap	Pacific Hydro	30 km S of Port Pirie, SA	Under construction	early 2010	57 MW	\$135 m
Crookwell 2	Union Fenosa Wind Australia	14 km SE of Crookwell, NSW	Under construction	2011	92 MW	\$238 m
Hallett 2	Energy Infrastructure Trust	20 km S of Burra, SA	Under construction	late 2009	71 MW	\$159 m
Hallett 4 (North Brown Hill)	Energy Infrastructure Investments	12 km SE of Jamestown, SA	Under construction	2011	132 MW	\$341 m
Lake Bonney stage 3	Infigen Energy	2 km E of Lake Bonney, SA	Under construction	2010	39 MW	na
Musselroe	Roaring 40s	Cape Portland, Tas	Under construction	2011	168 MW	\$425 m
Oaklands Wind Farm	AGL/ Windlab Systems	5 km S of Glenthompson, Vic	Under construction	2011	63 MW	\$200 m
Waterloo stage 1	Roaring 40s	30 km SE of Clare, SA	Under construction	2010	111 MW	\$300 m

Source: ABARE 2009b

**Table 9.8** Projects at a less advanced stage of development, as of October 2009

Project	Company	Location	Status	Start up	Capacity	Capital Expenditure
Allendale	Acciona Energy	20 km S of Mt Gambier, SA	Govt approval under way	na	70 MW	\$210 m
Ararat Wind Farm	Renewable Energy Development Australia	7 km N of Ararat, Vic	Govt approval under way	2011	225 MW	\$350 m
Arriga	Transfield Services	50 km SW of Cairns, Qld	Prefeasibility study under way	na	130 MW	na

Project	Company	Location	Status	Start up	Capacity	Capital Expenditure
Badgingara Wind Farm	Griffin Energy/ Stanwell Corporation	200 km N of Perth, WA	Feasibility study under way	2010	130 MW	na
Bald Hills Wind Farm	Mitsui	170 km SE of Melbourne, Vic	Govt approval received	2011	104 MW	na
Barn Hill	Transfield Services	Barn Hill, SA	Govt approval received	2010	130 MW	\$300 m
Baynton	Transfield Services	80 km N of Melbourne, Vic	Feasibility study under way	2013–14	130 MW	na
Ben Lomond Wind Farm	AGL	62 km N of Armidale, NSW	Govt approval under way	na	150 MW	\$300 m
Ben More	Transfield Services	150 km NW of Melbourne, Vic	Feasibility study under way	2014	90 MW	na
Berrybank Wind Farm	Union Fenosa Wind Australia	60 km E of Mortlake, Vic	Govt approval under way	2011	180–250 MW	\$484 m
Boco Rock Wind Farm	Wind Prospect	146 km SW of Nimmitabel, NSW	Govt approval under way	2012	270 MW	\$750 m
Carmody's Hill Wind Farm	Pacific Hydro	18 km N of Mt Misery, SA	Govt approval under way	na	140 MW	\$350 m
Cattle Hill Wind Farm	NP Power	5 km E of Lake Echo, Tas	EIS under way	2011	150–210 MW	na
Collector	Transfield Services	50 km NE of Canberra, NSW	Feasibility study under way	2013	150 MW	na
Collgar Wind Farm	Investec Bank/ Windlab Systems	25 km SE of Merredin, WA	Govt approval received	mid 2011	220 MW	\$600 m
Conroy's Gap Wind Farm	Origin Energy	17 km W of Yass, NSW	Govt approval received	na	30 MW	na
Cooper's Gap Wind Farm	AGL/ Windlab Systems	65 km S of Dalby, Qld	Govt approval under way	2011	440 MW	\$1.2 b
Crowlands Wind Farm	Pacific Hydro	30 km NE of Ararat, Vic	Govt approval under way	na	126 MW	\$360 m
Crows Nest Wind Farm	AGL	43 km N of Toowoomba, Qld	Feasibility study under way	na	150 MW	\$405–435 m
Darlington Wind Farm	Union Fenosa Wind Australia	5 km E of Mortlake, Vic	Feasibility study under way	2012	270–450 MW	\$720 m
Drysdale Wind Farm	Wind Farm Developments	3 km N of Purnim, Vic	Govt approval received	2011	30 MW	\$60–100 m
Flyers Creek Wind Farm	Flyers Creek Wind Farm	20 km S of Orange, NSW	Planning approval under way	na	80–100 MW	\$160–200 m
Glen Innes Wind Farm	Glen Innes Wind Power	Waterloo Range, NSW	EIS under way	na	44–81 MW	\$150 m
Gullen Range Wind Farm	Epuron	25 km NW of Goulburn, NSW	Govt approval under way	2010	248 MW	\$250 m
Gunning	Acciona Energy	40 km E of Goulburn, NSW	Govt approval received	na	46.5 MW	\$139.5 m
Hallett 3 (Mt Bryan)	AGL	Hallett, SA	Feasibility study under way	2011	80 MW	\$216–232 m
Hallett 5 (The Bluff)	AGL	12 km SE of Jamestown, SA	Feasibility study under way	na	50 MW	\$135–145 m
Hawkesdale Wind Farm	Union Fenosa Wind Australia	35 km N of Point Fairy, Vic	Govt approval received	2011	62 MW	\$150 m
High Road	Transfield Services	70 km SW of Cairns, Qld	Feasibility study under way	2012	50 MW	na
Keyneton	Pacific Hydro	10 km SE of Angaston, SA	Prefeasibility study under way	na	120 MW	na
Kongorong	Transfield Services	30 km SW of Mt Gambier, SA	Prefeasibility study under way	na	120 MW	na
Kulpara	Transfield Services	100 km NW of Adelaide, SA	Prefeasibility study under way	na	80 MW	na
Lal Lal Wind Farm	West Wind Energy	25 km SE of Ballarat, Vic	Govt approval received	2012	131 MW	\$320–360 m
Lexton Wind Farm	Wind Power Pty Ltd	44 km NW of Ballarat, Vic	Govt approval received	2011	38 MW	\$110 m
Lincoln Gap Wind Farm	NP Power/ Infigen Energy	near Port Augusta, SA	Govt approval received	2011	118 MW	na

Project	Company	Location	Status	Start up	Capacity	Capital Expenditure
Macarthur Wind Farm	AGL/ Meridian Energy	Macarthur, Vic	Govt approval received	2010	330 MW	\$850 m
Milyeannup Wind Farm	Verve Energy	20 km E of Augusta, WA	Govt approval under way	2011	55 MW	\$160 m
Moorabool Wind Project	West Wind Energy	25 km SE of Ballarat, Vic	Feasibility study under way	2014	220–360 MW	\$600 m
Mortlake Wind Farm	Acciona Energy	5 km S of Mortlake, Vic	Govt approval under way	0	144 MW	\$432 m
Morton's Lane	NewEn Australia	100 km N of Warrnambool, Vic	Govt approval received	na	30 MW	\$60 m
Mount Gellibrand Wind Farm	Acciona Energy	15 km NE of Colac, Vic	Govt approval received, on hold	na	232 MW	\$696 m
Mount Hill	Transfield Services	80 km NE of Port Lincoln, SA	Prefeasibility study under way	na	80 MW	na
Mount Mercer Wind Farm	West Wind Energy	30 km S of Ballarat, Vic	Govt approval received	2010	131 MW	\$320–360 m
Mumbida	Verve Energy	40 km S of Geraldton, WA	Feasibility study under way	2012	90 MW	\$250 m
Myponga	TrustPower	50 km S of Adelaide, SA	Govt approval received	na	40 MW	na
Naroghid Wind Farm	Wind Farm Developments	10 km N of Cobden, Vic	Govt approval received	2011	42 MW	\$60–100 m
Nilgen Wind Farm	Pacific Hydro	9 km E of Lancelin, SA	Govt approval under way	na	100 MW	\$280 m
Orford	Future Energy	28 km NW of Port Fairy, Vic	Feasibility study under way	na	100 MW	na
Paling Yards	Union Fenosa Wind Australia	84 km N of Goulburn, NSW	Feasibility study under way	2012	100–125 MW	\$312 m
Portland stage 4	Pacific Hydro	Cape Nelson North and Cape Sir William Grant, Vic	Govt approval under way	na	54 MW	na
Robertstown Wind Farm	Roaring 40s	123km N of Adelaide, SA	Planning approval under way	2014	70 MW	\$175 m
Ryan Corner Wind Farm	Union Fenosa Wind Australia	10 km NW of Port Fairy, Vic	Govt approval received	2011	136 MW	\$327 m
Sapphire Wind Farm	Wind Prospect	Inverrel, NSW	Govt approval under way	2012	356–485 MW	\$925–1250 m
Sidonia Hills Wind Farm	Roaring 40s	10 km NE of Kyneton, Vic	Planning approval under way	2012	68 MW	\$175 m
Silverton Wind Farm	Silverton Wind Farm Developments	25 km NW of Broken Hill, NSW	Govt approval received	2011	1000 MW	\$2.2 b
Snowtown stage 2	TrustPower	5 km W of Snowtown, SA	Govt approval received	2011	212 MW	na
Stockyard Hill Wind Farm	Origin Energy	35 km W of Ballarat, Vic	Planning approval under way	na	484 MW	\$1.4 b
Stony Gap Wind Farm	Roaring 40s	120 km N or Adelaide, SA	Planning approval under way	2013	100 MW	\$250 m
Taralga	RES Australia	3 km E of Taralga, NSW	Govt approval received	2011	110–165 MW	na
Tarrone	Union Fenosa Wind Australia	25 km N of Port Fairy, Vic	Feasibility study under way	2013	30–40 MW	\$90 m
The Sisters Wind Farm	Wind Farm Developments	12 km S of Mortlake, Vic	Planning approval under way	2013	30 MW	\$63 m
Tuki Wind Farm	Wind Power	37 km N of Ballarat, Vic	Prefeasibility study under way	na	38 MW	na
Vincent North	Pacific Hydro	Yorke Peninsula, SA	Govt approval under way	na	30 MW	\$100 m
Waubra North	Acciona Energy	8 km NE of Waubra, Vic	Feasibility study under way	na	75 MW	na
White Rock Wind Farm	Eureka Funds Management	100 km NE of Launceston, Tas	Prefeasibility study under way	2014	400 MW	na
Woodlawn Wind Farm	Acciona Energy	40 km S of Goulburn, NSW	Govt approval received, on hold	na	50 MW	\$150 m

Project	Company	Location	Status	Start up	Capacity	Capital Expenditure
Woolsthorpe Wind Farm	Wind Farm Developments	2 km W of Woolsthorpe, Vic	Govt approval received	2011	40 MW	\$60–100 m
Woorndoo (Salt Creek)	NewEn Australia	100 km SW of Ballarat, Vic	Govt approval received	na	30 MW	\$60m
Worlds End	AGL	Burra, SA	Feasibility study under way	na	180 MW	\$486–522 m
Yaloak Wind Farm	Pacific Hydro	35 km E of Ballarat, Vic	Planning approval under way	na	30 MW	na
Yass Wind Farm	Epuron	20 km W of Yass, NSW	Govt approval under way	na	364–600 MW	\$800 m

Source: ABARE 2009b

## 9.5 References

ABARE (Australian Bureau of Agricultural and Resource Economics), 2009a, Australian Energy Statistics, Canberra, August

ABARE, 2009b, Electricity generation: Major development projects – October 2009 listing, Canberra, November

ABARE, 2010, Australian energy projections to 2029–30, ABARE research report 10.02, prepared for the Department of Resources, Energy and Tourism, Canberra

Ackermann T, 2005, Wind Power in Power Systems. John Wiley & Sons Pty. Ltd., Chichester, England

AEMC (Australian Energy Market Commission), 2009, Review of Energy Market frameworks in light of Climate Change Policies. Final Report. September 2009, Sydney

AEMO (Australian Energy Market Operator), 2009, National transmission statement: National grid 2030 for a low carbon Australia, December 2009, <<http://www.aemo.com.au/planning/nts2009.html>>

AER (Australian Energy Regulator), 2009, State of the Energy Market 2009. The Australian Competition and Consumer Commission, Melbourne, 321pp

American Wind Energy Association, 2009, American Wind Energy Association, viewed 10 June 2009, <<http://www.awea.org>>

Beck S and Haarmeyer D, 2009, The upside in the downturn: Realigning the wind industry. Renewable Energy World Magazine, 12 (March-April), 1-6

Blanco MI, 2009, The economics of wind energy, Renewable and Sustainable Energy Reviews, Vol. 13, pp. 1372–1382

British Wind Energy Association, 2005, Low Frequency Noise and Wind Turbines Technical Annex, February 2005, <<http://www.bwea.com/pdf/lfn-annex.pdf>>

Commission of the European Communities, 2005, The support of electricity from renewable energy sources, Commission of the European Communities, Brussels

Coppin PA, Ayotte KA and Steggel N, 2003, Wind resource assessment in Australia – a planners guide, Wind Energy Research Unit, CSIRO Land and Water

Czisch G, 2001, Global Renewable Energy Potential – Approaches to its Use, viewed 10 June 2009, <<http://www.iset.uni-kassel.de/abt/w3-w/fohlen/magdeb030901/>>

Dale L, Milborrow D, Slark R and Strbac G, 2004. Total cost estimates for large-scale wind scenarios in UK, Energy Policy, Vol. 32, pp. 1949–1956

Danish Wind Industry Association (DWIA), 2009, Danish Wind Industry Association, accessed on 29/07/2009, <<http://www.windpower.org/en/core.htm>>

Department of Resources Energy and Tourism (RET), 2009, Clean Energy Initiative, Department of Resources Energy and Tourism, Canberra

Energy Information Administration (EIA), 2009, International Energy Outlook, Washington, May, <<http://www.eia.doe.gov/oiarf/ieo/index.html>>

ESIPC (Electricity Supply Industry Planning Council), 2005, South Australian wind power study. Planning Council Wind Report to ECOSA (Essential Services Commission of South Australia), <[http://www.esipc.sa.gov.au/webdata/resources/files/Planning\\_Council\\_Wind\\_Report\\_to\\_ESCOSA.pdf](http://www.esipc.sa.gov.au/webdata/resources/files/Planning_Council_Wind_Report_to_ESCOSA.pdf)>

Geoscience Australia, 2009, Map of operating renewable energy generators in Australia, accessed on 30/07/2009, <<http://www.ga.gov.au/renewable/>>

GWEC (Global Wind Energy Council), 2008, Global wind energy outlook, Brussels, October

GWEC, 2009, Global wind 2008 report, Brussels

IEA (International Energy Agency), 2008, IEA wind energy: annual report 2008, OECD, Paris

IEA, 2009a, World Energy Balances (2009 edition), OECD, Paris

IEA, 2009b, World Energy Outlook, OECD, Paris

Krohn S, Morthorst P-E and Awerbuch S, 2009, The Economics of Wind Energy, The European Wind Energy Association (EWEA), Brussels, March

Lenzen M, 2009, Current state of development of electricity-generating technologies: a literature review, Integrated Sustainability Analysis, The University of Sydney, Sydney

Mathew S, 2006, Wind energy: fundamentals, resource analysis and economics, Birkhäuser

National Wind Watch (NWW), 2009, Cost of pumped hydro storage, accessed on 29/07/2009, <<http://www.wind-watch.org/documents/cost-of-pumped-hydro-storage/>>

Prescott R and Van Kooten GC, 2009, Economic costs of managing of an electricity grid with increasing wind power penetration, Climate Policy, Vol. 9, Iss. 2, pp. 155–169

Sustainable Energy Authority Victoria (SEAV), 2003, Victorian Wind Atlas, Department of Primary Industries, Melbourne, <<http://www.dpi.vic.gov.au/DPI/dpinenergy.nsf/>>

Sustainable Energy Development Authority, 2002, The New South Wales Wind Atlas, Department of Industry and Investment, Sydney, <<http://www.industry.nsw.gov.au/energy/sustainable/renewable/wind>>

U.S. Department of Energy (DOE), 2008, 20% Wind Energy by 2030: Increasing Wind Energy's Contribution to U.S. Electricity Supply, Washington, July

WEC (World Energy Council), 2007, Survey of Energy Resources 2007, London, <[http://www.worldenergy.org/documents/ser2007\\_final\\_online\\_version\\_1.pdf](http://www.worldenergy.org/documents/ser2007_final_online_version_1.pdf)>

Windfacts, 2009, Wind Energy: the facts. Accessed: 29/07/2009, <<http://www.wind-energy-the-facts.org/en/>>

# Chapter 10

## Solar Energy



### 10.1 Summary

#### KEY MESSAGES

- Solar energy is a vast and largely untapped resource. Australia has the highest average solar radiation per square metre of any continent in the world.
- Solar energy is used mainly in small direct-use applications such as water heating. It accounts for only 0.1 per cent of total primary energy consumption, in Australia as well as globally.
- Solar energy use in Australia is projected to increase by 5.9 per cent per year to 24 PJ in 2029–30.
- The outlook for electricity generation from solar energy depends critically on the commercialisation of large-scale solar energy technologies that will reduce investment costs and risks.
- Government policy settings will continue to be an important factor in the solar energy market outlook. Research, development and demonstration by both the public and private sectors will be crucial in accelerating the development and commercialisation of solar energy in Australia, especially large-scale solar power stations.

#### 10.1.1 World solar energy resources and market

- The world's overall solar energy resource potential is around 5.6 gigajoules (GJ) (1.6 megawatt-hours (MWh)) per square metre per year. The highest solar resource potential is in the Red Sea area, including Egypt and Saudi Arabia.
- Solar energy accounted for 0.1 per cent of world total primary energy consumption in 2007, although its use has increased significantly in recent years.
- Government policies and falling investment costs and risks are projected to be the main factors underpinning future growth in world solar energy use.
- The International Energy Agency (IEA) in its reference case projects the share of solar energy in total electricity generation will increase to 1.2 per cent in 2030 – 1.7 per cent in OECD countries and 0.9 per cent in non-OECD countries.

#### 10.1.2 Australia's solar energy resources

- The annual solar radiation falling on Australia is approximately 58 million petajoules (PJ), approximately 10 000 times Australia's annual energy consumption.
- Solar energy resources are greater in the northwest and centre of Australia, in areas that do not have access to the national electricity grid. Accessing solar energy resources in these areas

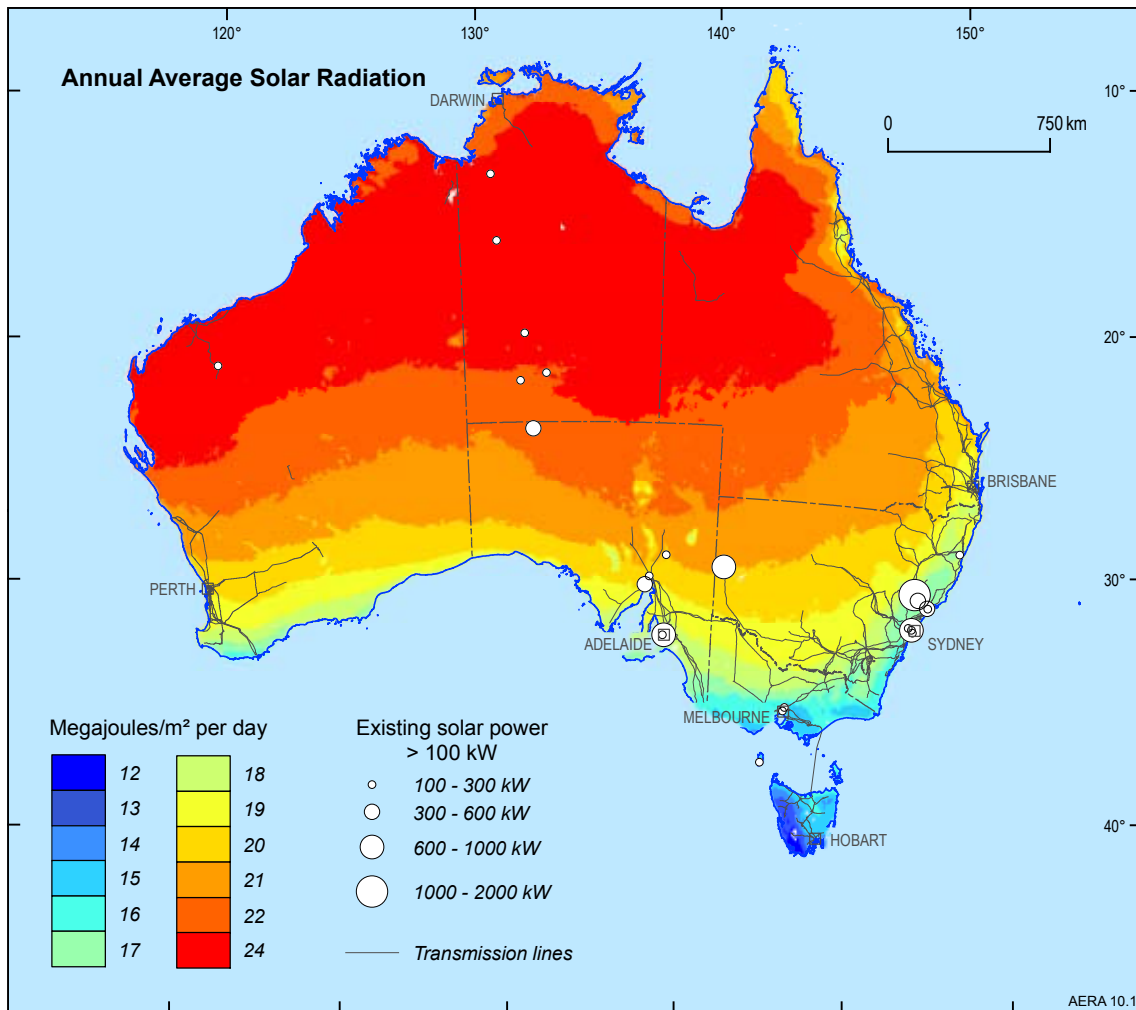
is likely to require investment in transmission infrastructure (figure 10.1).

- There are also significant solar energy resources in areas with access to the electricity grid. The solar energy resource (annual solar radiation) in areas of flat topography within 25 km of existing transmission lines (excluding National Parks), is nearly 500 times greater than the annual energy consumption of Australia.

#### 10.1.3 Key factors in utilising Australia's solar resources

- Solar radiation is intermittent because of daily and seasonal variations. However, the correlation between solar radiation and daytime peak electricity demand means that solar energy has the potential to provide electricity during peak demand times.
- Solar thermal technologies can also operate in hybrid systems with fossil fuel power plants, and, with appropriate storage, have the potential to provide base load electricity generation. Solar thermal technologies can also potentially provide electricity to remote townships and mining centres where the cost of alternative electricity sources is high.
- Photovoltaic systems are well suited to off-grid electricity generation applications, and where costs of electricity generation from other sources are high (such as in remote communities).





**Figure 10.1** Annual average solar radiation (in MJ/m<sup>2</sup>) and currently installed solar power stations with a capacity of more than 10 kW

**Source:** Bureau of Meteorology 2009; Geoscience Australia

- Relatively high capital costs and risks remain the primary limitation to more widespread use of solar energy. Government climate change policies, and research, development and demonstration (RD&D) by both the public and private sectors will be critical in the future commercialisation of large scale solar energy systems for electricity generation.
- The Australian Government has established a Solar Flagships Program at a cost of \$1.5 billion as part of its Clean Energy Initiative to support the construction and demonstration of large scale (up to 1000 MW) solar power stations in Australia.

#### 10.1.4 Australia's solar energy market

- In 2007–08, Australia's solar energy use represented 0.1 per cent of Australia's total primary energy consumption. Solar thermal water heating has been the predominant form of solar energy use to date, but electricity generation is increasing through the deployment of photovoltaic

and concentrating solar thermal technologies.

- In ABARE's latest long-term energy projections, which include the Renewable Energy Target, a 5 per cent emissions reduction target, and other government policies, solar energy use in Australia is projected to increase from 7 PJ in 2007–08 to 24 PJ in 2029–30 (figure 10.2). Electricity generation from solar energy is projected to increase from 0.1 TWh in 2007–08 to 4 TWh in 2029–30 (figure 10.3).

## 10.2 Background information and world market

### 10.2.1 Definitions

**Solar** power is generated when energy from the sun (sunlight) is converted into electricity or used to heat air, water, or other fluids. As illustrated in figure 10.4, there are two main types of solar energy technologies:

- Solar thermal** is the conversion of solar radiation into thermal energy (heat). Thermal energy carried by air, water, or other fluid is commonly used directly, for space heating, or to generate electricity using steam and turbines. Solar thermal is commonly used for hot water systems. Solar thermal electricity, also known as concentrating solar power, is typically designed for large scale power generation.
- Solar photovoltaic (PV)** converts sunlight directly into electricity using photovoltaic cells. PV systems can be installed on rooftops, integrated into building designs and vehicles, or scaled up to megawatt scale power plants. PV systems can also be used in conjunction with concentrating mirrors or lenses for large scale centralised power.

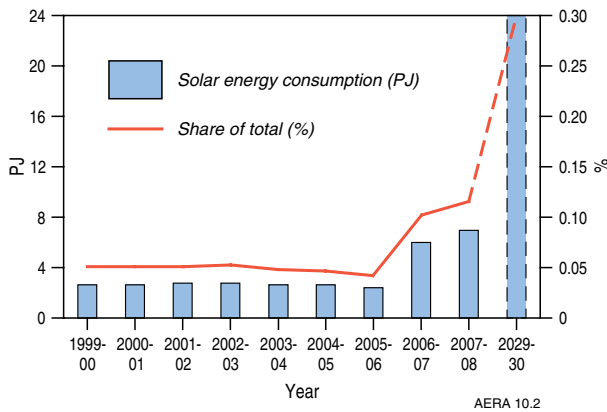


Figure 10.2 Projected primary consumption of solar energy in Australia

Source: ABARE 2009a, 2010

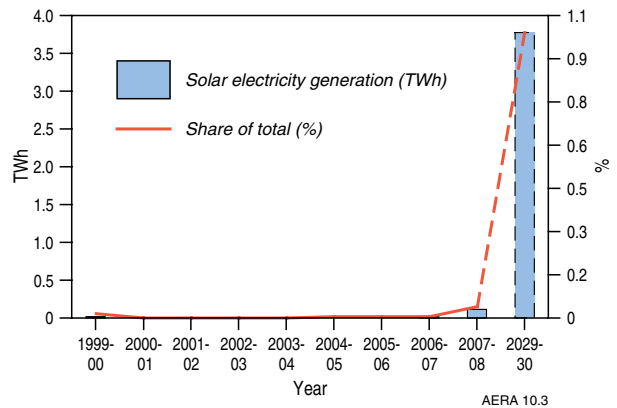


Figure 10.3 Projected electricity generation from solar energy in Australia

Source: ABARE 2009a, 2010

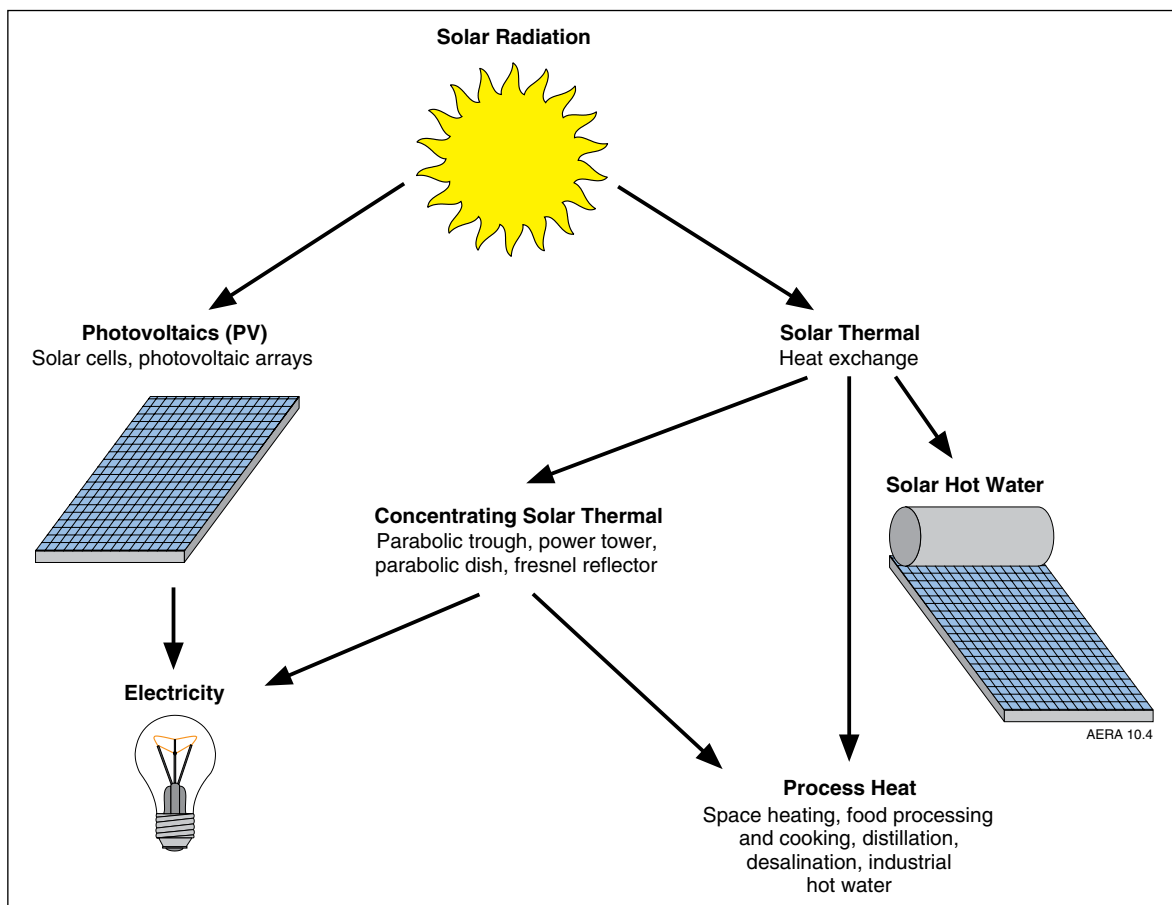


Figure 10.4 Solar energy flows

Source: ABARE and Geoscience Australia

Solar thermal and PV technology can also be combined into a single system that generates both heat and electricity. Further information on solar thermal and PV technologies is provided in boxes 10.2 and 10.3 in section 10.4.

### 10.2.2 Solar energy supply chain

A representation of the Australian solar industry is given in figure 10.5. The potential for using solar energy at a given location depends largely on the solar radiation, the proximity to electricity load centres, and the availability of suitable sites. Large scale solar power plants require approximately 2 hectares of land per MW of power. Small scale technologies (solar water heaters, PV modules and small-scale solar concentrators) can be installed on existing structures, such as rooftops. Once a solar project is developed, the energy is captured by heating a fluid or gas or by using photovoltaic cells. This energy can be used directly as hot water supply, converted to electricity, used as process heat, or stored by various means, such as thermal storage, batteries, pumped hydro or synthesised fuels.

### 10.2.3 World solar energy market

The world has large solar energy resources which have not been greatly utilised to date. Solar energy currently accounts for a very small share of world primary energy consumption, but its use is projected to increase strongly over the outlook period to 2030.

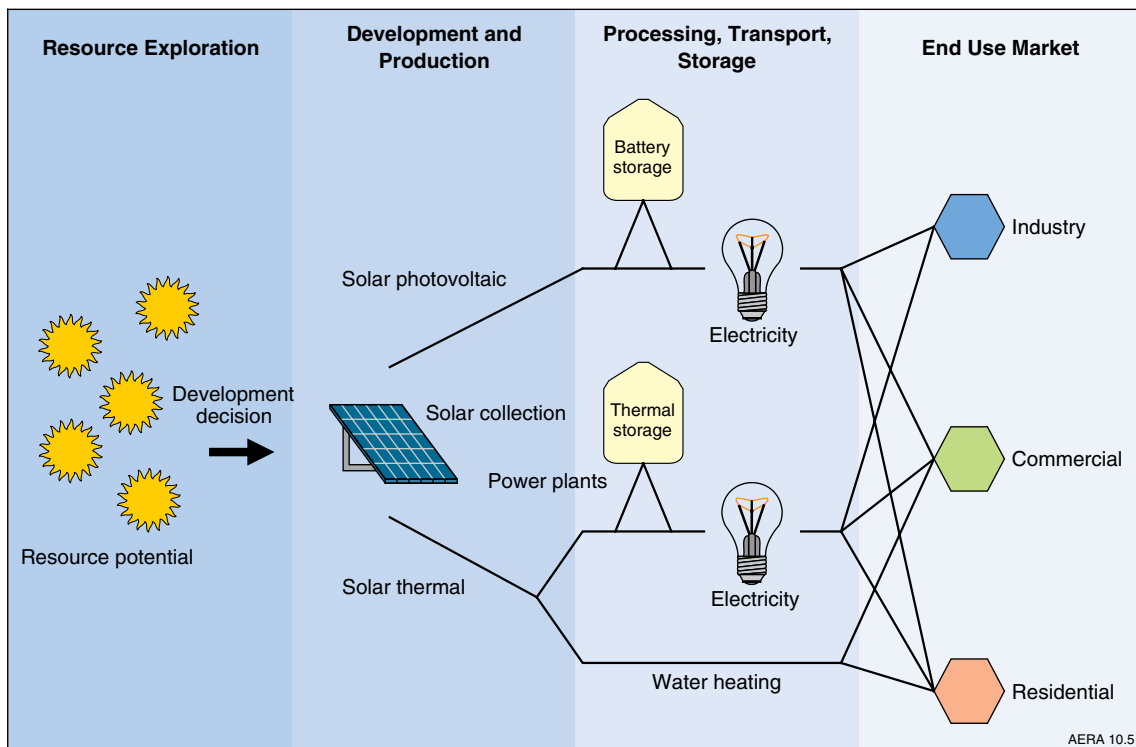
The highest solar resource potential per unit land area is in the Red Sea area. Australia also has higher incident solar energy per unit land area than any other continent in the world. However, the distribution of solar energy use amongst countries reflects government policy settings that encourage its use, rather than resource availability.

### World solar resources

The amount of solar energy incident on the world's land area far exceeds total world energy demand. Solar energy thus has the potential to make a major contribution to the world's energy needs. However, large scale solar energy production is currently limited by its high capital cost.

The annual solar resource varies considerably around the world. These variations depend on several factors, including proximity to the equator, cloud cover, and other atmospheric effects. Figure 10.6 illustrates the variations in solar energy availability.

The Earth's surface, on average, has the potential to capture around 5.4 GJ (1.5 MWh) of solar energy per square metre a year (WEC 2007). The highest resource potential is in the Red Sea area, including Egypt and Saudi Arabia (figure 10.6). Australia and the United States also have a greater solar resource potential than the world average. Much of this potential can be explained by proximity to the equator and average annual weather patterns.



**Figure 10.5** Australia's solar energy supply chain

Source: ABARE and Geoscience Australia

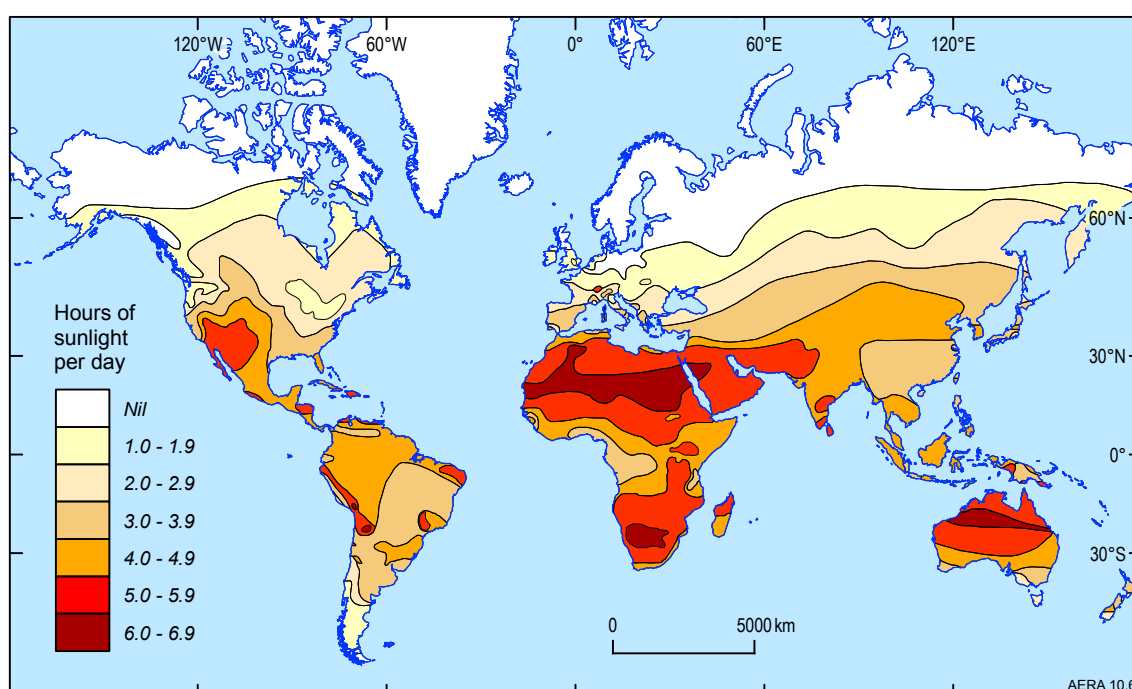
### Primary energy consumption

Since solar energy cannot currently be stored for more than several hours, nor traded in its primary form, solar energy consumption is equal to solar energy production. Long term storage of solar energy is currently undergoing research and development, but has not yet reached commercial status.

Solar energy contributes only a small proportion to Australia's primary energy needs, although its share is comparable to the world average. While solar energy accounts for only around 0.1 per cent of world primary energy consumption, its use has been

increasing at an average rate of 10 per cent per year from 2000 to 2007 (table 10.1). Increased concern with environmental issues surrounding fossil fuels, coupled with government policies that encourage solar energy use, have driven increased uptake of solar technologies, especially PV.

From 1985 to 1989, world solar energy consumption increased at an average rate of 19 per cent per year (figure 10.7). From 1990 to 1998, the rate of growth in solar energy consumption decreased to 5 per cent per year, before increasing strongly again from 1999 to 2007 (figure 10.7).



**Figure 10.6** Hours of sunlight per day, during the worst month of the year on an optimally tilted surface

Source: Sunwize Technologies 2008

**Table 10.1** Key statistics for the solar energy market

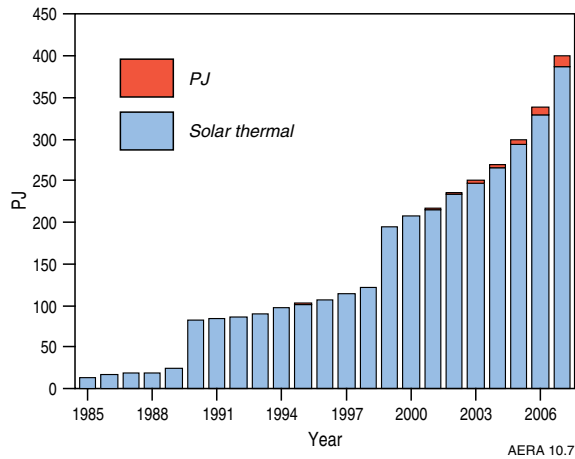
	unit	Australia 2007-08	OECD 2008	World 2007
<b>Primary energy consumption<sup>a</sup></b>	PJ	6.9	189.4	401.8
Share of total	%	0.12	0.09	0.08
Average annual growth, from 2000	%	7.2	4.3	9.6
<b>Electricity generation</b>				
Electricity output	TWh	0.1	8.2	4.8
Share of total	%	0.04	0.08	0.02
Average annual growth, from 2000	%	26.1	36.3	30.8
Electricity capacity	GW	0.1	8.3	14.7

<sup>a</sup> Energy production and primary energy consumption are identical

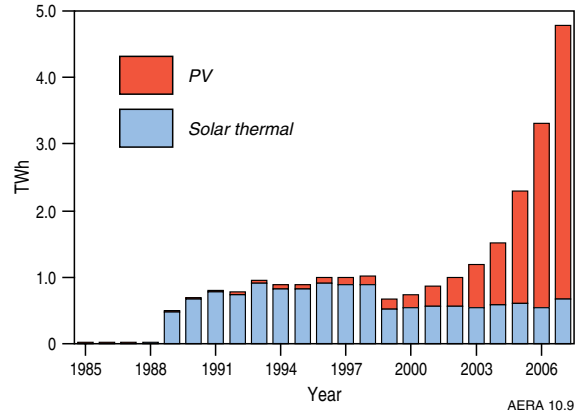
Source: IEA 2009b; ABARE 2009a; Watt 2009; EPIA 2009

The majority of solar energy is produced using solar thermal technology; solar thermal comprised 96 per cent of total solar energy production in 2007 (figure 10.7). Around half is used for water heating in the residential sector. Most of

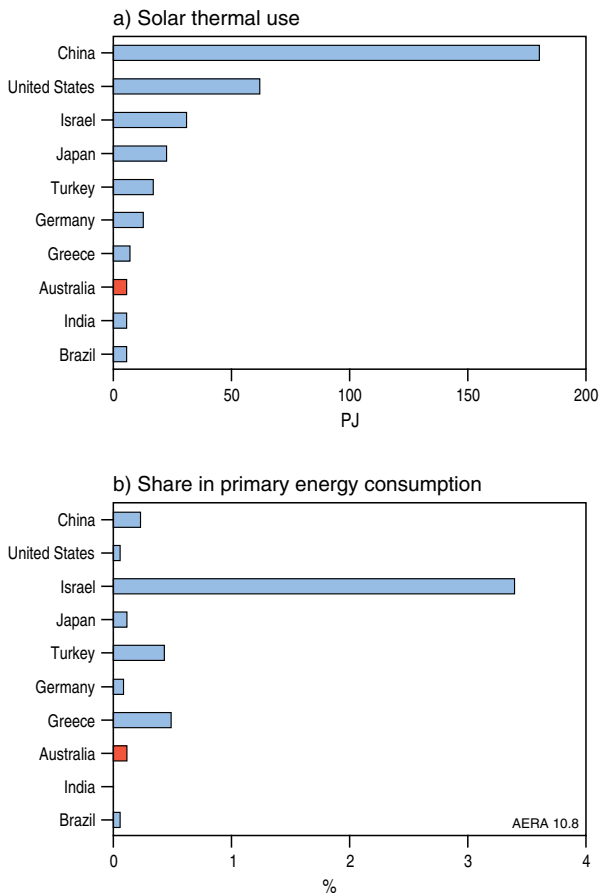
the remainder is used for space heating either residentially or commercially, and for heating swimming pools. All of the energy used for these purposes is collected using solar thermal technology.



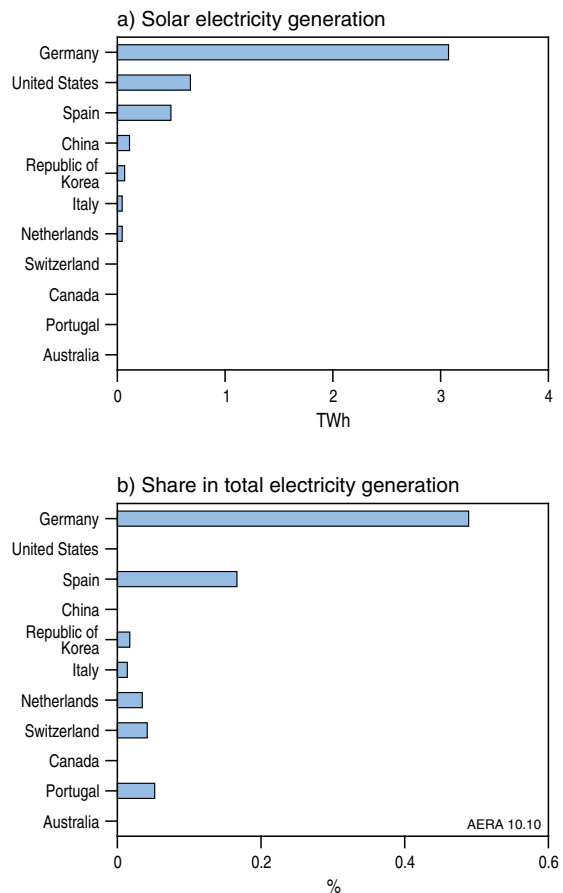
**Figure 10.7** World primary solar energy consumption, by technology  
**Source:** IEA 2009b



**Figure 10.9** World electricity generation from solar energy, by technology  
**Source:** IEA 2009b



**Figure 10.8** Direct use of solar thermal energy, by country, 2007  
**Source:** IEA 2009b



**Figure 10.10** Electricity generation from solar energy, major countries, 2007  
**Source:** IEA 2009b



### Solar thermal energy consumption

The largest users of solar thermal energy in 2007 were China (180 PJ), the United States (62 PJ), Israel (31 PJ) and Japan (23 PJ). However, Israel has a significantly larger share of solar thermal in its total primary energy consumption than any other country (figure 10.8). Growth in solar thermal energy use in these countries has been largely driven by government policies.

### Electricity generation

Electricity generation accounts for around 5 per cent of primary consumption of solar energy. All solar photovoltaic energy is electricity, while around

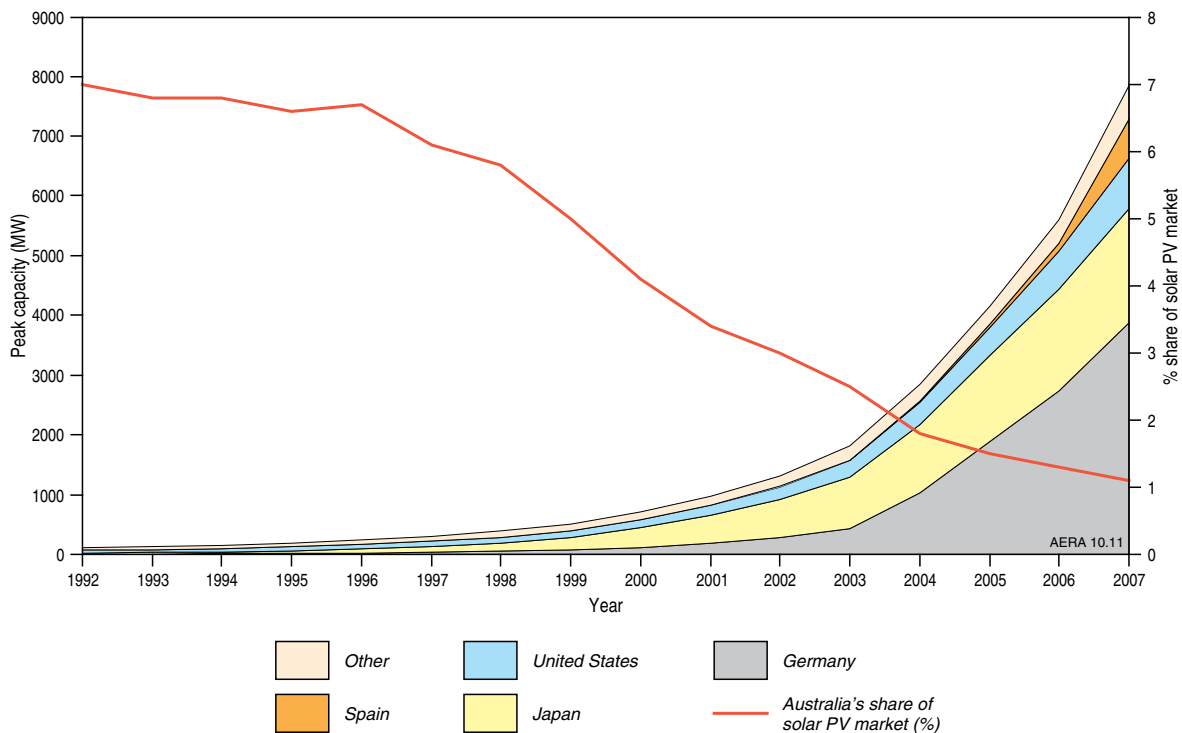
3 per cent of solar thermal energy is converted to electricity. Until 2003, more solar thermal energy was used to generate electricity than solar photovoltaic energy (figure 10.9).

The largest producers of electricity from solar energy in 2007 were Germany (3.1 TWh), the United States (0.7 TWh) and Spain (0.5 TWh), with all other countries each producing 0.1 TWh or less (figure 10.10). Germany had the largest share of solar energy in electricity generation, at 0.5 per cent. It is important to note that these electricity generation data do not include off-grid PV installations, which represent a large part of PV use in some countries.

**Table 10.2** IEA reference case projections for world solar electricity generation

	unit	2007	2030
<b>OECD</b>	TWh	4.60	220
Share of total	%	0.05	1.66
Average annual growth, 2007–2030	%	-	18
<b>Non-OECD</b>	TWh	0.18	182
Share of total	%	0.00	0.86
Average annual growth, 2007–2030	%	-	35
<b>World</b>	TWh	4.79	402
Share of total	%	0.02	1.17
Average annual growth, 2007–2030	%	-	21

Source: IEA 2009a



**Figure 10.11** World PV Capacity, 1992–2007, including off-grid installations

Source: IEA-PVPS 2008

### Installed PV generation capacity

The IEA's estimates of total PV electricity generation capacity (including off-grid generation) show that Japan (1.9 GW) and the United States (0.8 GW) had the second and third largest PV capacity in 2007, following Germany with 3.9 GW (figure 10.11). Over 90 per cent of this capacity was connected to grids (WEC 2009).

### World market outlook

Government incentives, falling production costs and rising electricity generation prices are projected to result in increases in solar electricity generation. Electricity generation from solar energy is projected to increase to 402 TWh by 2030, growing at an average rate of 21 per cent per year to account for 1.2 per cent of total generation (table 10.2). Solar electricity is projected to increase more significantly in non-OECD countries than in OECD countries, albeit from a much smaller base.

PV systems installed in buildings are projected to be the main source of growth in solar electricity generation to 2030. PV electricity is projected to

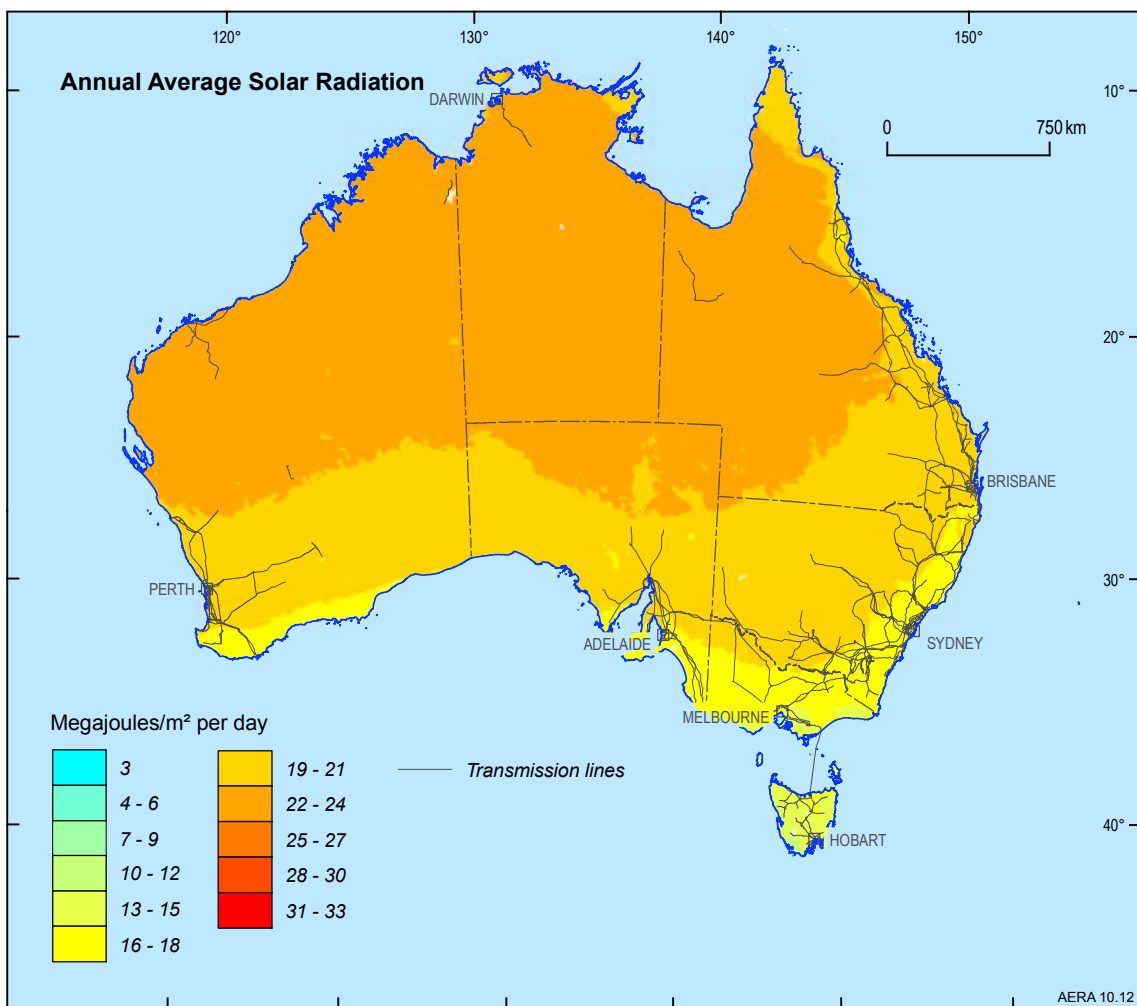
increase to almost 280 TWh in 2030, while electricity generated from concentrating solar power systems is projected to increase to almost 124 TWh by 2030 (IEA 2009a).

## 10.3 Australia's solar energy resources and market

### 10.3.1 Solar resources

As already noted, the Australian continent has the highest solar radiation per square metre of any continent (IEA 2003); however, the regions with the highest radiation are deserts in the northwest and centre of the continent (figure 10.12).

Australia receives an average of 58 million PJ of solar radiation per year (BoM 2009), approximately 10 000 times larger than its total energy consumption of 5772 PJ in 2007–08 (ABARE 2009a). Theoretically, then, if only 0.1 per cent of the incoming radiation could be converted into usable energy at an efficiency of 10 per cent, all of Australia's energy needs could be supplied by solar energy. Similarly, the energy falling on a solar



**Figure 10.12** Annual average solar radiation

Source: Bureau of Meteorology 2009

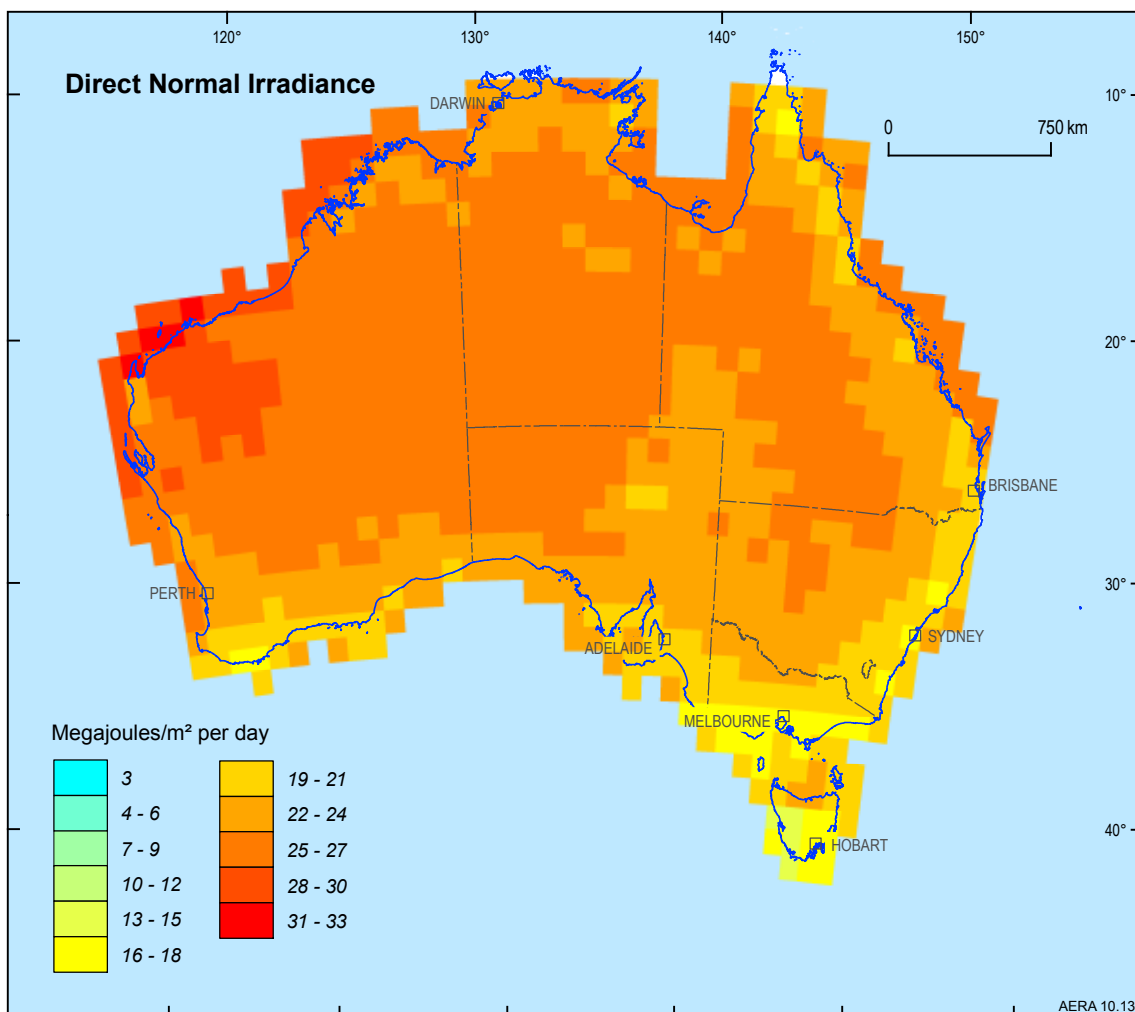
farm covering 50 km by 50 km would be sufficient to meet all of Australia's electricity needs (Stein 2009a). Given this vast and largely untapped resource, the challenge is to find effective and acceptable ways of exploiting it.

While the areas of highest solar radiation in Australia are typically located inland, there are some grid-connected areas that have relatively high solar radiation. Wyld Group and MMA (2008) identified a number of locations that are suitable for solar thermal power plants, based on high solar radiation levels, proximity to local loads, and high electricity costs from alternative sources. Within the National Electricity Market (NEM) grid catchment area, they identified the Port Augusta region in South Australia, north-west Victoria, and central and north-west New South Wales as regions of high potential for solar thermal power. They also nominated Kalbarri, near Geraldton, Western Australia, on the South-West Interconnected System, the Darwin-Katherine Interconnected System, and Alice Springs-Tennant Creek as locations of high potential for solar thermal power.

### Concentrating solar power

Figure 10.12 shows the radiation falling on a flat plane. This is the appropriate measure of radiation for flat plate PV and solar thermal heating systems, but not for concentrating systems. For concentrating solar power, including both solar thermal power and concentrating PV, the Direct Normal Irradiance (DNI) is a more relevant measure of the solar resource. This is because concentrating solar technologies can only focus sunlight coming from one direction, and use tracking mechanisms to align their collectors with the direction of the sun. The only dataset currently available for DNI that covers all of Australia is from the Surface Meteorology and Solar Energy dataset from the National Aeronautics and Space Administration (NASA). This dataset provides DNI at a coarse resolution of 1 degree, equating to a grid length of approximately 100 km. The annual average DNI from this dataset is shown in figure 10.13.

Since the grid cell size is around 10 000 km<sup>2</sup>, this dataset provides only a first order indication of the DNI across broad regions of Australia. However, it is adequate to demonstrate that the spatial distribution



**Figure 10.13** Direct Normal Solar Irradiance

Source: NASA 2009

of DNI differs from that of the total radiation shown in figure 10.12. In particular, there are areas of high DNI in central New South Wales and coastal regions of Western Australia that are less evident in the total radiation. More detailed mapping of DNI across Australia is needed to assess the potential for concentrating solar power at a local scale.

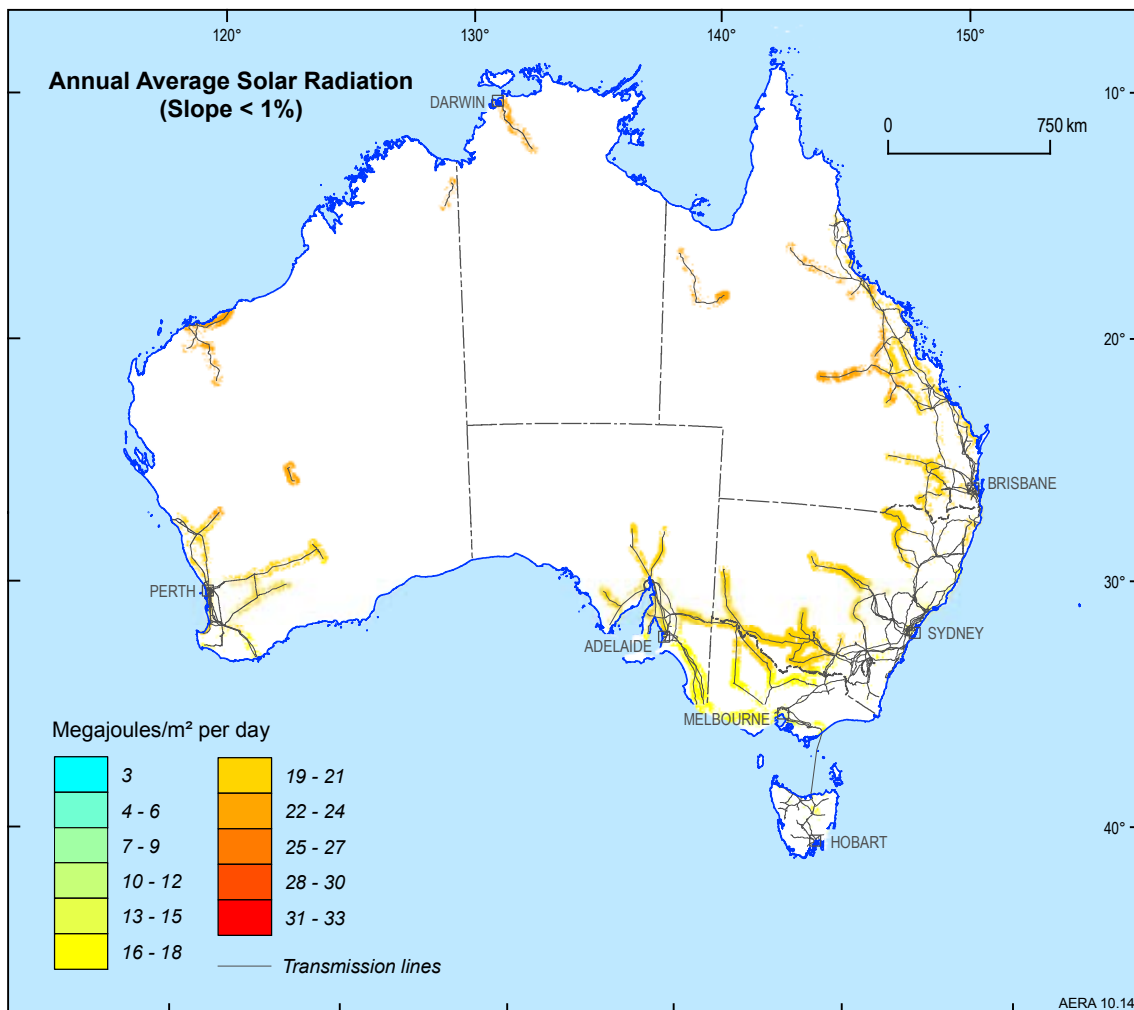
Some types of solar thermal power plants, including parabolic troughs and Fresnel reflectors, need to be constructed on flat land. It is estimated that about 2 hectares of land are required per MW of power produced (Stein 2009a). Figure 10.14 shows solar radiation, where land with a slope of greater than 1 per cent, and land further than 25 km from existing transmission lines has been excluded. Land within National Parks has also been excluded. These exclusion thresholds of slope and distance to grid are not precise limits but intended to be indicative only. Even with these limits, the annual radiation falling on the coloured areas in figure 10.14 is 2.7 million PJ, which amounts to nearly 500 times the annual energy demand of Australia. Moreover,

power towers, dishes and PV systems are not restricted to flat land, which renders even this figure a conservative estimate.

### Seasonal variations in resource availability

There are also significant seasonal variations in the amount of solar radiation reaching Australia. While summer radiation levels are generally very high across all of inland Australia, winter radiation has a much stronger dependence on latitude. Figures 10.15 and 10.16 show a comparison of the December and June average daily solar radiation. The same colour scheme has been used throughout figures 10.12 to 10.16 to allow visual comparison of the amount of radiation in each figure.

In some states, such as Victoria, South Australia and Queensland, the seasonal variation in solar radiation correlates with a seasonal variation in electricity demand. These summer peak demand periods – caused by air-conditioning loads – coincide with the hours that the solar resource is at its most abundant. However, the total demand across the National Electricity Market (comprising all of the



**Figure 10.14** Annual solar radiation, excluding land with a slope of greater than 1 per cent and areas further than 25 km from existing transmission lines

**Source:** Bureau of Meteorology 2009; Geoscience Australia

eastern states, South Australia and Tasmania) is relatively constant throughout the year, and occasionally peaks in winter due to heating loads (AER 2009).

### 10.3.2 Solar energy market

Australia's modest production and use of solar energy is focussed on off-grid and residential installations. While solar thermal water heating has been the predominant form of solar energy use to date, production of electricity from PV and concentrating solar thermal technologies is increasing.

#### Primary energy consumption

Australia's primary energy consumption of solar energy accounted for 2.4 per cent of all renewable energy use and around 0.1 per cent of primary energy consumption in 2007–08 (ABARE 2009a). Production and consumption of solar energy are the same, because solar energy can only be stored for several hours at present.

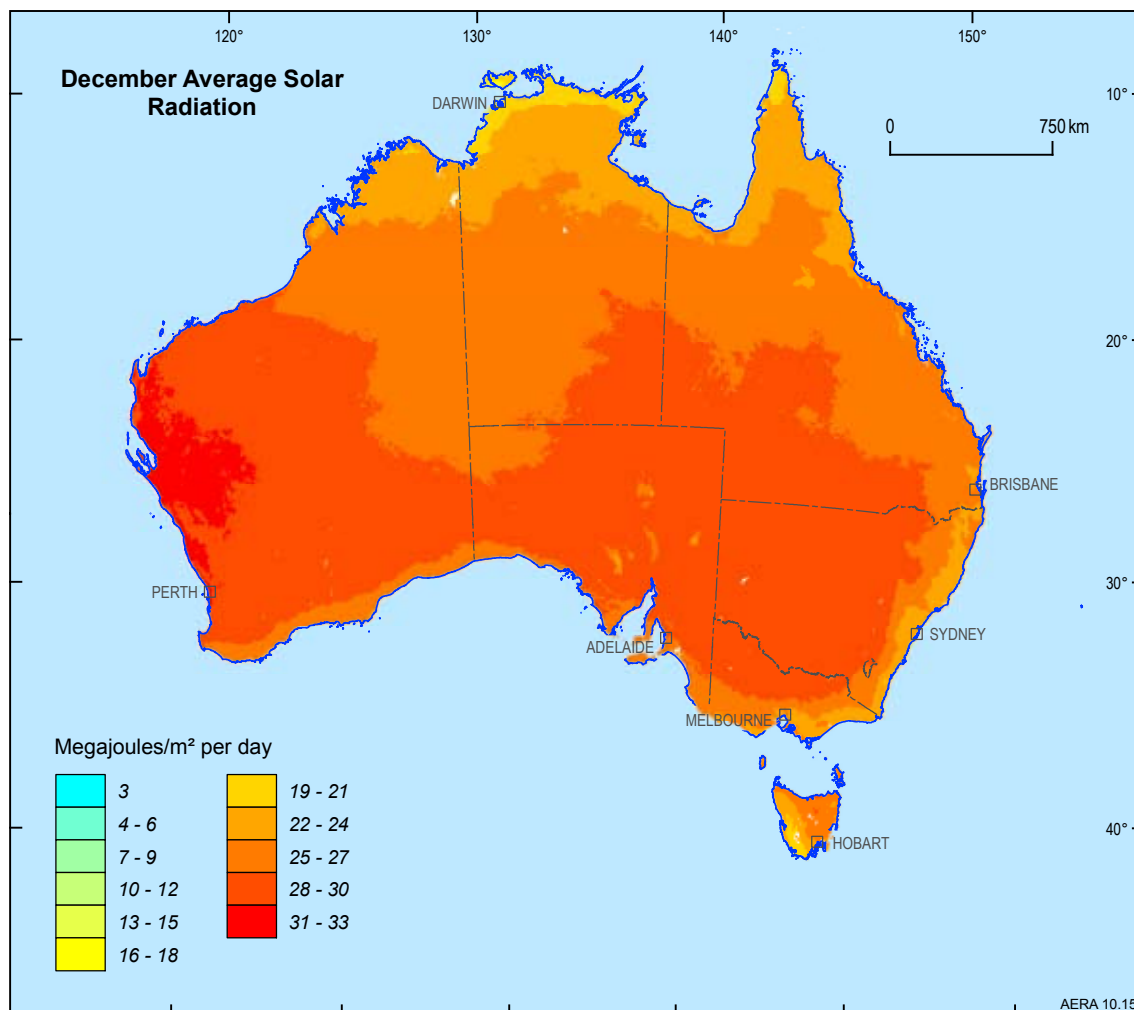
Over the period from 1999–2000 to 2007–08, Australia's solar energy use increased at an average rate of 7.2 per cent per year. However, as illustrated

in figure 10.17, the growth rate was not constant; there was considerable variation from year to year. The bulk of growth over this period was in the form of solar thermal systems used for domestic water heating. PV is also used to produce a small amount of electricity. In total, Australia's solar energy consumption in 2007–08 was 6.9 PJ (1.9 TWh), of which 6.5 PJ (1.8 TWh) were used for water heating (ABARE 2009a).

#### Consumption of solar thermal energy, by state

Statistics on PV energy consumption by state are not available. However, PV represents only 5.8 per cent of total solar energy consumption; on that basis, statistics on solar thermal consumption by state provide a reasonable approximation of the distribution of total solar energy consumption.

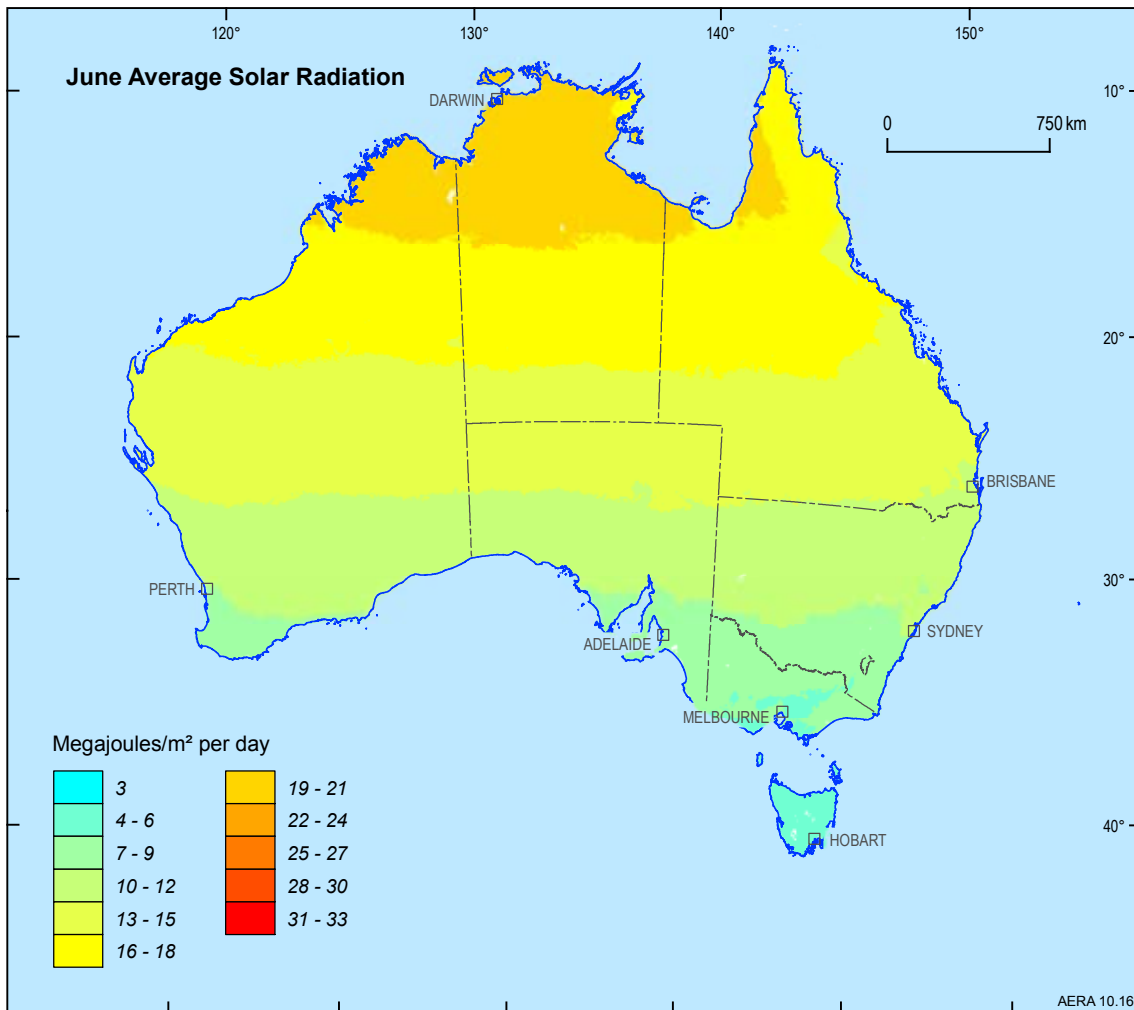
Western Australia has the highest solar energy consumption in Australia, contributing 40 per cent of Australia's total solar thermal use in 2007–08 (figure 10.18). New South Wales and Queensland contributed another 26 per cent and 15 per cent respectively. The rate of growth of solar energy use



**Figure 10.15** December average solar radiation

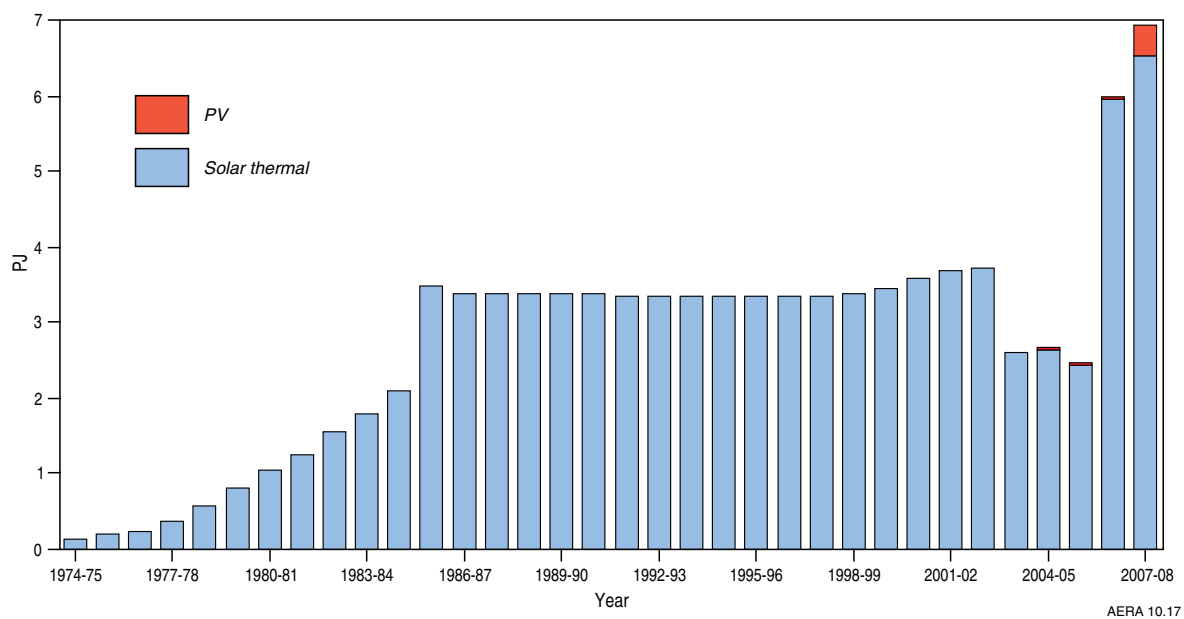
Source: Bureau of Meteorology 2009





**Figure 10.16** June average solar radiation

Source: Bureau of Meteorology 2009



**Figure 10.17** Australia's primary consumption of solar energy, by technology

Source: IEA 2009b; ABARE 2009a

over the past decade has been similar in all states and territories, ranging from an average annual growth of 7 per cent in the Northern Territory and Victoria, to an average annual growth of 11 per cent in New South Wales.

A range of government policy settings from both Australian and State governments have resulted in a significant increase in the uptake of small-scale solar hot water systems in Australia. The combination of drivers, including the solar hot water rebate, state building codes, the inclusion of solar hot water under the Renewable Energy Target and the mandated phase-out of electric hot water by 2012, have all contributed to the increased uptake of solar hot water systems from 7 per cent of total hot water system installations in 2007 to 13 per cent in 2008 (BIS Shrapnel 2008; ABARE 2009a).

### Electricity generation

Electricity generation from solar energy in Australia is currently almost entirely sourced from PV installations, primarily from small off-grid systems. Electricity generation from solar thermal systems is currently limited to small pilot projects, although interest in solar thermal systems for large scale electricity generation is increasing.

Some care in analysis of generation data in energy statistics is warranted. For energy accounting purposes, the fuel inputs to a solar energy system are assumed to equal the energy generated by the solar system. Thus, the solar electricity fuel inputs in energy statistics represent the solar energy captured by solar energy systems, rather than the significantly larger measure of total solar radiation falling on solar energy systems; however this radiation is not measured in energy statistics. Fossil fuels such as gas and coal are measured in terms

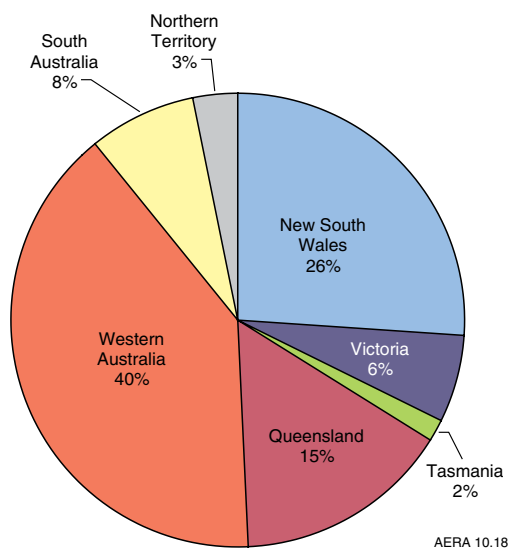
of both their thermal fuel input, and their electrical output. The result of this difference between fuel inputs and energy output for fossil fuels is that solar represents a larger share of electricity generation output than of fuel inputs to electricity generation.

In 2007–08, 0.11 TWh (0.4 PJ) of electricity were generated from solar energy, representing 0.04 per cent of Australian electricity generation (figure 10.19). Despite its small share, solar electricity generation has increased rapidly in recent years.

### Installed electricity generation capacity

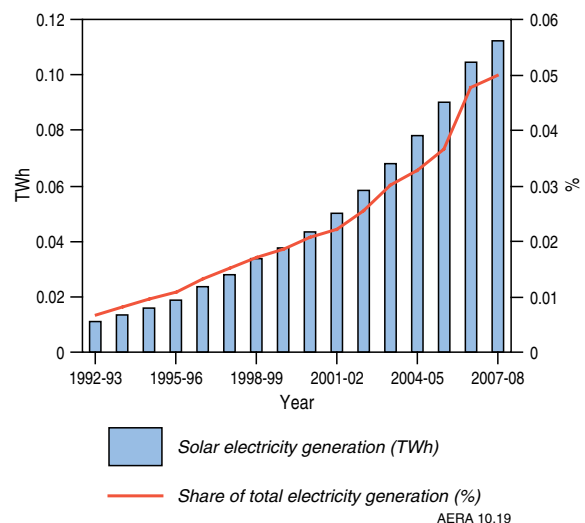
Australia's total PV capacity has increased significantly over the last decade (figure 10.20), and in particular over the last two years. This has been driven primarily by the Solar Homes and Communities Plan for on-grid applications and the Remote Renewable Power Generation Program for off-grid applications. Over the last two years, there has been a dramatic increase in the take-up of small scale PV, with more than 40 MW installed in 2009 (figures 10.20, 10.23). This is due to a combination of factors: support provided through the Solar Homes and Communities program, greater public awareness of solar PV, a drop in the price of PV systems, attributable both to greater international competition among an increased number of suppliers and a decrease in worldwide demand as a result of the global financial crisis, a strong Australian dollar, and highly effective marketing by PV retailers.

Most Australian states and territories have in place, or are planning to implement, feed-in tariffs. While there is some correlation of their introduction with increased consumer uptake, it is too early to suggest that these tariffs have been significant contributors to it. The combination of government policies, associated public and private investment in RD&D measures and broader market conditions are likely to be the main influences.



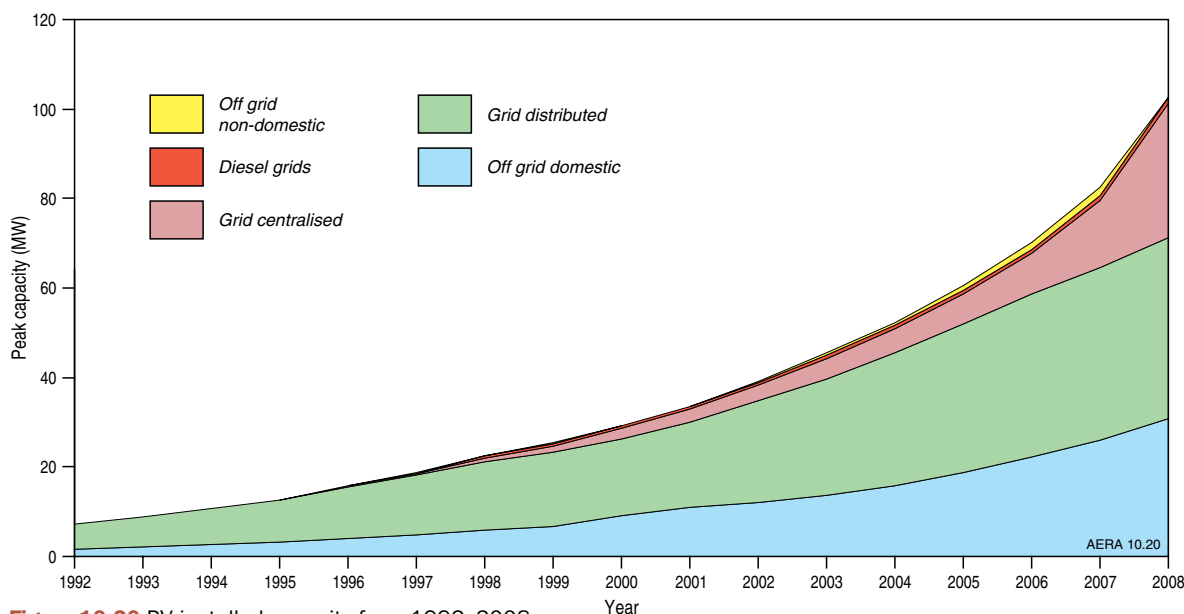
**Figure 10.18** Solar thermal energy consumption, by state, 2007–08

Source: ABARE 2009a



**Figure 10.19** Australian electricity generation from solar energy

Source: ABARE



**Figure 10.20** PV installed capacity from 1992–2008

**Note:** These estimates represent the peak power output of PV systems. They do not represent the average power output over a year, as solar radiation varies according to factors such as the time of day, the number of daylight hours, the angle of the sun and the cloud cover. These capacity estimates are consistent with the PV production data presented in this report

**Source:** Watt 2009

The largest component of installed solar electricity capacity is used for off-grid industrial and agricultural purposes (41 MW), with significant contributions coming from off-grid residential systems (31 MW), and grid connected distributed systems (30 MW). This large off-grid usage reflects the capacity of PV systems to be used as stand-alone generating systems, particularly for small scale applications. There have also been several commercial solar projects that provide electricity to the grid.

#### Recently completed solar projects

Five commercial-scale solar projects with a combined capacity of around 5 MW have been commissioned in Australia since 1998 (table 10.3). All of these projects are located in New South Wales. Commissioned solar projects to date have had small capacities with four of the five projects commissioned having a capacity of less than or equal to 1 MW. The only project to have a capacity of more than 1 MW

**Table 10.3** Recently completed solar projects

Project	Company	State	Start up	Capacity
Singleton	Energy Australia	NSW	1998	0.4 MW
Newington	Private	NSW	2000	0.7 MW
Broken Hill	Australian Inland Energy	NSW	2000	1 MW
Newcastle	CSIRO	NSW	2005	0.6 MW
Liddell	Ausra	NSW	Late 2008	2 MW

**Source:** Geoscience Australia 2009

is Ausra's 2008 solar thermal attachment to Liddell power plant, which has a peak electric power capacity of 2 MW (Ausra 2009). While somewhat larger than the more common domestic or commercial installations, these are modestly-sized plants. However, there are plans for construction of several large scale solar power plants under the Australian Government's Solar Flagships Program, which will use both solar thermal and PV technologies.

### 10.4 Outlook to 2030 for Australia's resources and market

Solar energy is a renewable resource: increased use of the resource does not affect resource availability. However, the quantity of the resource that can be economically captured changes over time through technological developments.

The outlook for the Australian solar market depends on the cost of solar energy relative to other energy resources. At present, solar energy is more expensive for electricity generation than other currently used renewable energy sources, such as hydro, wind, biomass and biogas. Therefore, the outlook for increased solar energy uptake depends on factors that will reduce its costs relative to other renewable fuels. The competitiveness of solar energy and renewable energy sources generally will also depend on government policies aimed at reducing greenhouse gas emissions.

Solar energy is likely to be an economically attractive option for remote off-grid electricity generation. The long-term competitiveness of solar energy in large-

scale grid-connected applications depends in large measure on technological developments that enhance the efficiency of energy conversion and reduce the capital and operating cost of solar energy systems and componentry. The Australian Government's \$1.5 billion Solar Flagships program, announced as part of the Clean Energy Initiative, will support the construction and demonstration of large scale (up to 1000 MW) solar power stations in Australia. It will accelerate development solar technology and help position Australia as a world leader in that field.

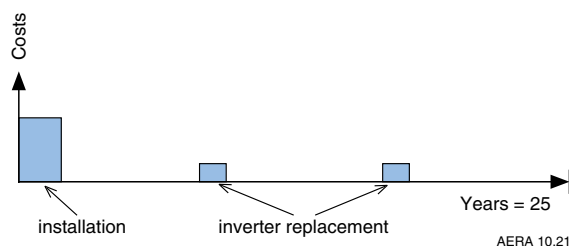
#### 10.4.1 Key factors influencing the future development of Australia's solar energy resources

Australia is a world leader in developing solar technologies (Lovegrove and Dennis 2006), but uptake of these technologies within Australia has been relatively low, principally because of their high cost. A number of factors affect the economic viability of solar installations.

##### Solar energy technologies and costs

Research into both solar PV and solar thermal technologies is largely focussed on reducing costs and increasing the efficiency of the systems.

- **Electricity generation** – commercial-scale generation projects have been demonstrated to be possible but the cost of the technology is still relatively high, making solar less attractive and higher risk for investors. Small-scale solar PV arrays are currently best suited to remote and off-grid applications, with other applications largely dependent on research or government funding to make them viable. Information on solar energy technologies for electricity generation is presented in box 10.1.
- **Direct-use applications** – solar thermal hot water systems for domestic use represent the most widely commercialised solar energy technology.



**Figure 10.21** Indicative solar PV production profile and costs

Source: ABARE

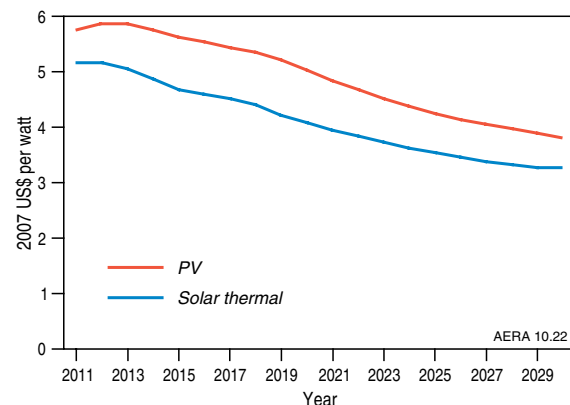
Solar water heaters are continuing to be developed further, and can also be integrated with PV arrays. Other direct uses include passive solar heating, and solar air conditioning. Information on solar energy technologies for direct-use applications is presented in box 10.2.

With both solar PV and solar thermal generation, the majority of costs are borne in the capital installation phase, irrespective of the scale or size of the project (figure 10.21). The largest cost components of PV installations are the cells or panels and the associated components required to install and connect the panels as a power source. In addition, the inverter that converts the direct current to alternating current needs to be replaced at least once every 10 years (Borenstein 2008). However, there are no fuel costs – once the system is installed, apart from replacing the inverter, there should be no costs associated with running the system until the end of its useful life (20 to 25 years). The major challenge, therefore, is initial outlay, with somewhat more modest periodic component replacement, and payback period for the investment.

Currently, the cost of solar energy is higher than other technologies in most countries. The minimum cost for solar PV in areas with high solar radiation is around US 23 cents per kWh (EIA 2009).

Solar thermal systems have a similar profile to PV, depending on the scale and type of installation. The cost of electricity production from solar energy is expected to decline as new technologies are developed and economies of scale improve in the production processes.

The cost of installing solar capacity has generally been decreasing. Both PV and solar thermal technologies currently have substantial research and development funds directed toward them, and new production processes are expected to result in a continuation of this trend (figure 10.22). In the United



**Figure 10.22** Projected average capital costs for new electricity generation plants using solar energy, 2011 to 2030

Source: EIA 2009

States, the capital cost of new PV plants is projected to fall by 37 per cent (in real terms) from 2009 to 2030 (EIA 2009).

The Electric Power Research Institute (EPRI) has developed estimates of the levelised cost of technology<sup>a</sup>, including a range of solar technologies, to enable the comparison of technologies at different levels of maturity (Chapter 2, figures 2.18, 2.19). The solar technologies considered are parabolic troughs, central receiver systems, fixed PV systems and tracking PV systems. Central receiver solar systems with storage are forecast to have the lowest costs of technology in 2015. Adding storage to the central receiver systems or to parabolic troughs is estimated to decrease the cost per kWh produced, as it allows the system to produce a higher electricity output. Tracking PV systems are forecast to have the lowest cost of the options that do not incorporate storage. The EPRI technology status data in figures 2.18 and 2.19 show that, although solar technologies remain relatively high cost options throughout the outlook period, significant reductions in cost are anticipated by 2030. The substantial global RD&D (by governments and the private sector) into solar technologies, including the Australian Government's \$1.5 billion Solar Flagships Program to support the construction and demonstration of large scale solar power stations in Australia, is expected to play a key role in accelerating the development and deployment of solar energy.

The time taken to install or develop a solar system is highly dependent on the size and scale of the project. Solar hot water systems can be installed in around four hours. Small-scale PV systems can similarly be installed quite rapidly. However, commercial scale developments take considerably longer, depending on the type of installation and other factors, including broader location or environmental considerations.

### Location of the resource

In Australia, the best solar resources are commonly distant from the national electricity market (NEM), especially the major urban centres on the eastern seaboard. This poses a challenge for developing new solar power plants, as there needs to be a balance between maximising the solar radiation and minimising the costs of connectivity to the electricity grid. However, there is potential for solar thermal energy application to provide base and intermediate load electricity with fossil-fuel plants (such as gas turbine power stations) in areas with isolated grid systems and good insolation resources. The report by the Wyld Group and MMA (2008) identified Mount Isa, Alice Springs, Tennant Creek and the Pilbara region as areas with these characteristics. Access to Australia's major solar energy resources – as with other remote renewable energy sources – is likely to require investment to extend the electricity grid.

Stand-alone PV systems can be located close to customers (for example on roof areas of residential buildings), which reduces the costs of electricity transmission and distribution. However, concentrating solar thermal technologies require more specific conditions and large areas of land (Lorenz, Pinner and Seitz 2008) which are often only available long distances from the customers needing the energy. In Australia, installing small-scale residential or medium scale commercial systems (both PV and thermal) can be highly attractive options for remote areas where electricity infrastructure is difficult or costly to access, and alternative local sources of electricity are expensive.

### Government policies

Government policies have been implemented at several stages of the solar energy production chain in Australia. Rebates provided for solar water heating systems and residential PV installations reduce the cost of these technologies for consumers and encourage their uptake.

The Solar Homes and Communities Plan (2000 to June 2009) provided rebates for the installation of solar PV systems. The capacity of PV systems installed by Australian households increased significantly under this program (figure 10.23). The expanded RET scheme includes the *Solar Credits* initiative, which provides a multiplied credit for electricity generated by small solar PV systems. *Solar Credits* provides an up-front capital subsidy towards the installation of small solar PV systems.

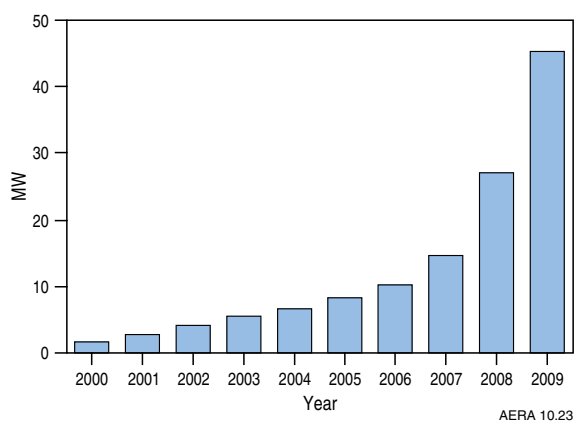
The Australian Government has also announced \$1.5 billion of new funding for its Solar Flagships program. This program aims to install up to four new solar power plants, with a combined power output of up to 1000 MW, made up of both PV and solar thermal power plants, with the locations and technologies to be determined by a competitive tender process. The program aims to demonstrate new solar technologies at a commercial scale, thereby accelerating uptake of solar energy in general and providing the opportunity for Australia to develop leadership in solar energy technology (RET 2009b).

The Australian Government has also allocated funding to establish the Australian Solar Institute (ASI), which will be based in Newcastle. It will have strong collaborative links with CSIRO and Universities undertaking R&D in solar technologies. The institute will aim to drive development of solar thermal and PV technologies in Australia, including the areas of efficiency and cost effectiveness (RET 2009a).

Other government policies, including feed-in tariffs, which are proposed or already in place in most Australian states and territories, may also encourage the uptake of solar energy.

<sup>a</sup> This EPRI technology status data enables the comparison of technologies at different levels of maturity. It should not be used to forecast market and investment outcomes.





**Figure 10.23** Residential PV capacity installed under the Solar Homes and Communities Plan (as of October 2009)

Source: DEWHA 2009

### Infrastructure issues

The location of large scale solar power plants in Australia will be influenced by the cost of connection to the electricity grid. In the short term, developments are likely to focus on isolated grid systems or nodes to the existing electricity grid, since this minimises infrastructure costs.

In the longer term, the extension of the grid to access remote solar energy resources in desert regions may require building long distance transmission lines. The technology needed to achieve this exists: high voltage direct current (HVDC) transmission lines are able to transfer electricity over thousands of kilometres, with minimal losses. Some HVDC lines are already in use in Australia, and are being used to form interstate grid connections; the longest example being the HVDC link between Tasmania and Victoria. However, building a HVDC link to a solar power station in desert areas would require a large up-front investment.

The idea of generating large scale solar energy in remote desert regions has been proposed on a much larger scale internationally. In June 2009 the DESERTEC Foundation outlined a proposal to build large scale solar farms in the sun-rich regions of the Middle East and Northern Africa, and export their power to Europe using long distance HVDC lines. More recently, an Asia Pacific Sunbelt Development Project has been established with the aim of moving solar energy by way of fuel rather than electricity from regions such as Australia to those Asian countries who import energy, such as Japan and Korea. These projects illustrate the growing international interest in utilising large scale solar power from remote and inhospitable areas, despite the infrastructure challenges in transmitting or transporting energy over long distances.

### Environmental issues

A roof-mounted, grid-connected solar system in Australia is estimated to yield more than seven times

the energy required to produce it over a 20 year system lifespan (MacKay 2009). In areas with less solar radiation, such as Central-Northern Europe, the energy yield ratio is estimated to be around four. This positive energy yield ratio also means that greenhouse gas emissions generated from the production of solar energy systems are more than offset over the systems' life cycle, as there are no greenhouse gas emissions generated from their operation.

Most solar thermal electricity generation systems require water for steam production and this water use affects the efficiency of the system. The majority of this water is consumed in 'wet cooling' towers, which use evaporative cooling to condense the steam after it has passed through the turbine. In addition, solar thermal systems require water to wash the mirrors, to maintain their reflectivity (Jones 2008). It is possible to use 'dry cooling' towers, which eliminate most of the water consumption, but this reduces the efficiency of the steam cycle by approximately 10 per cent (Stein 2009b).

A further option under development is the use of high temperature Brayton cycles, which do not use steam turbines and thus do not consume water. Brayton cycles are more efficient than conventional Rankine (steam) cycles, but they can only be achieved by point-focussing solar thermal technologies (power towers and dishes).

### 10.4.2 Outlook for solar energy market

Although solar energy is more abundant in Australia than other renewable energy sources, plans for expanding solar energy in Australia generally rely on subsidies to be economically viable. There are currently only a small number of proposed commercial solar energy projects, mostly of small scale. Solar energy is currently more expensive to produce than other forms of renewable energy, such as hydro, wind and biomass (Wyld Group and MMA 2008). In the short term, therefore, solar energy will find it difficult to compete commercially with other forms of clean energy for electricity generation in the NEM. However, as global deployment of solar energy technologies increases, the cost of the technologies is likely to decrease. Moreover, technological developments and greenhouse gas emission reduction policies are expected to drive increased use of solar energy in the medium and long term.

#### Key projections to 2029–30

ABARE's latest (2010) Australian energy projections include the RET, a 5 per cent emissions reduction target, and other government policies. Solar energy use in Australia is projected to more than triple, from 7 PJ in 2007–08 to 24 PJ in 2029–30, growing at an average rate of 5.9 per cent a year (figure 10.27, table 10.4). While solar water heating is projected to remain the predominant use for solar energy, the share of PV in total solar energy use is projected to increase.

## BOX 10.1 SOLAR ENERGY TECHNOLOGIES FOR ELECTRICITY GENERATION

Sunlight has been used for heating by generating fire for hundreds of years, but commercial technologies specifically to use solar energy to directly heat water or generate power were not developed until the 1800s. Solar water heaters developed and installed between 1910 and 1920 were the first commercial application of solar energy. The first PV cells capable of converting enough energy into power to run electrical equipment were not developed until the 1950s and the first solar power stations (thermal and PV) with capacity of at least 1 megawatt started operating in the 1980s.

### *Solar thermal electricity*

Solar thermal electricity is produced by converting sunlight into heat, and then using the heat to drive a generator. The sunlight is concentrated using mirrors, and focussed onto a solar receiver. This receiver contains a working fluid that absorbs the concentrated sunlight, and can be heated up to very high temperatures. Heat is transferred from the working fluid to a steam turbine, similar to those used in fossil fuel and nuclear power stations. Alternatively, the heat can be stored for later use (see below).

There are four main types of concentrating solar receivers, shown in figure 10.24. Two of these types are line-focussing (parabolic trough and Linear Fresnel reflector); the other two are point-focussing (paraboloidal dish and power tower). Each of these types is designed to concentrate a large area of sunlight onto a small receiver, which enables fluid to be heated to high temperatures. There are trade-offs between efficiency, land coverage, and costs of each type.

The most widely used solar concentrator is the parabolic trough. Parabolic troughs focus light in one axis only, which means that they need only a single axis tracking mechanism to follow the direction of the sun. The linear Fresnel reflector achieves a similar line-focus, but instead uses an array of almost flat mirrors. Linear Fresnel reflectors achieve a weaker focus (therefore lower temperatures and efficiencies) than parabolic troughs. However, linear Fresnel reflectors have cost-saving features that compensate for lower energy efficiencies, including a greater yield per unit land, and simpler construction requirements.

The paraboloidal dish is an alternate design which focuses sunlight onto a single point. This design is able to produce a much higher temperature at the



**Figure 10.24** The four types of solar thermal concentrators: (a) parabolic trough, (b) compact linear Fresnel reflector, (c) paraboloidal dish, and (d) power tower

**Source:** Wikimedia Commons, photograph by kjkolb; Wikimedia Commons, original uploader was Lkruisw at en.wikipedia; Australian National University 2009a; CSIRO

receiver, which increases the efficiency of energy conversion. The paraboloidal dish has the greatest potential to be used in modular form, which may give this design an advantage in off-grid and remote applications. However, to focus the sunlight onto a single point, paraboloidal dishes need to track the direction of sunlight on two axes. This requires a more complex tracking mechanism, and is more expensive to build. The other point focusing design is the 'power tower', which uses a series of ground-based mirrors to focus onto an elevated central receiver. Power tower mirrors also require two-axis tracking mechanisms; however the use of smaller, flat mirrors can reduce costs.

The parabolic trough has the most widespread commercial use. An array of nine parabolic trough plants producing a combined 354 MW have operated in California since the 1980s. Several new ones have been built in Spain and Nevada in the last few years at around a 50–60 MW scale, and there are many parabolic trough plants either in the construction or planning phase. While parabolic troughs have the majority of the current market share, all four designs are gaining renewed commercial interest. There is an 11 MW solar power tower plant operating in Spain, and a similar 20 MW plant has recently begun operating at the same location. The linear Fresnel reflector has been demonstrated on a small scale (5 MW), and a 177 MW plant is planned for construction in California. The paraboloidal dish has also been demonstrated on a small scale, and there are plans for large scale dish plants.

Methods of power conversion and thermal storage vary from type to type. While solar thermal plants are generally suited to large scale plants (greater than 50 MW), the paraboloidal dish has the potential to be used in modular form. This may give dish systems an advantage in remote and off-grid applications.

#### *Efficiency of solar thermal*

The conversion efficiency of solar thermal power plants depends on the type of concentrator used, and the amount of sunlight. In general, the point-focusing concentrators (paraboloidal dish and power tower) can achieve higher efficiencies than line focussing technologies (parabolic trough and Fresnel reflector). This is possible because the point-focussing technologies achieve higher temperatures for higher thermodynamic limits.

The highest value of solar-to-electric efficiency ever recorded for a solar thermal system was 31.25 per cent, using a solar dish in peak sunlight conditions (Sandia 2009). Parabolic troughs can achieve a peak solar-to-electric efficiency of over 20 per cent (SEGS 2009). However, the conversion efficiency drops significantly when the radiation drops in intensity,

so the annual average efficiencies are significantly lower. According to Begay-Campbell (2008), the annual solar-to-electric efficiency is approximately 12–14 per cent for parabolic troughs, 12 per cent for power towers (although emerging technologies can achieve 18–20 per cent), and 22–25 per cent for paraboloidal dishes. Linear Fresnel reflectors achieve a similar efficiency to parabolic troughs, with an annual solar-to-electric efficiency of approximately 12 per cent (Mills et al. 2002).

#### *Energy storage*

Solar thermal electricity systems have the potential to store energy over several hours. The working fluid used in the system can be used to temporarily store heat, and can be converted into electricity after the sun has stopped shining. This means that solar thermal plants have the potential to dispatch power at peak demand times. It should be noted, however, that periods of sustained cloudy weather cut the productive capacity of solar thermal power. The seasonality of sunshine also reduces power output in winter.

Thermal storage is one of the key advantages of solar thermal power, and creates the potential for intermediate or base-load power generation. Although thermal storage technology is relatively new, several recently constructed solar thermal power plants have included thermal storage of approximately 7 hours' power generation. In addition, there are new power tower designs that incorporate up to 16 hours of thermal storage, allowing 24 hour power generation in appropriate conditions. The development of cost effective storage technologies may enable a much higher uptake of solar thermal power in the future (Wyld Group and MMA 2008).

Current research is developing alternative energy storage methods, including chemical storage, and phase-change materials. Chemical storage options include dissociated ammonia and solar-enhanced natural gas. These new storage methods have the potential to provide seasonal storage of solar energy, or to convert solar energy into portable fuels. In future, it may be possible for solar fuels to be used in the transport sector, or even for exporting solar energy.

#### *Hybrid operation with fossil fuel plants*

Solar thermal power plants can make use of existing turbine technologies that have been developed and refined over many decades in fossil fuel technologies. Using this mature technology can reduce manufacturing costs and increase the efficiency of power generation. In addition, solar thermal heat collectors can be used in hybrid operation with fossil fuel burners. A number of existing solar thermal power plants use gas burners to boost power supply during low levels of sunlight.



Combining solar thermal power with gas can provide a hedge against the intermittency of sunlight.

Solar thermal heat collectors can be attached to existing coal or gas power stations to pre-heat the water used in these plants. This is possible since solar thermal heat collectors perform a very similar function to fossil fuel burners. In this way, solar thermal power can make use of existing infrastructure. This option is not affected by intermittency of sunlight, since the fossil fuel burners provide firm capacity of production. Internationally, there are several new integrated solar combined cycle (ISCC) plants planned for construction. ISCC plants are similar to combined cycle gas plants (using both a gas turbine, and a steam turbine), but use solar thermal heat collectors to boost the steam turbine production.

#### *Solar updraft towers*

An alternative solar thermal power technology is the solar updraft tower, also known as a solar chimney. The updraft tower captures solar energy using a large greenhouse, which heats air beneath a transparent roof. A very tall chimney is placed at the centre of the greenhouse, and the heated air creates pressure differences that drive air flow up the chimney. Electricity is generated from the air flow using wind turbines at the base of the chimney.

Solar updraft towers have been tested at a relatively small scale, with a 50 kW plant in Spain being the only working prototype at present. There are plans to upscale this technology, including a proposed 200 MW plant in Buronga, NSW. The main disadvantage of solar updraft towers is that they deliver significantly less power per unit area than concentrating solar thermal and PV systems (Enviromission 2009).

#### *Photovoltaic systems*

The costs of producing PV cells has declined rapidly in recent years as uptake has increased (Fthenakis

et al. 2009) and a number of PV technologies have been developed. The cost of modules can be reduced in four main ways:

- making thinner layers – reducing material and processing costs;
- integrating PV panels with building elements such as glass and roofs – reducing overall system costs;
- making adhesive on site – reducing materials costs; and
- improving decisions about making or buying inputs, increasing economies of scale, and improving the design of PV modules.

There are three main types of PV technology: crystalline silicon, thin-film and concentrating PV. Crystalline silicon is the oldest and most widespread technology. These cells are becoming more efficient over time, and costs have fallen steadily.

Thin-film PV is an emerging group of technologies, targeted at reducing costs of PV cells. Thin-film PV is at an earlier stage of development, and currently delivers a lower efficiency than crystalline silicon, estimated at around 10 per cent, although many of the newer varieties still deliver efficiencies of less than this (Prowse 2009). However, this is compensated by lower costs, and there are strong prospects for efficiency improvements in the future. Thin-film PV can be installed on many different substrates, giving it great flexibility in its applications.

Concentrating PV systems use either mirrors or lenses to focus a large area of sunlight onto a central receiver (figure 10.25). This increases the intensity of the light, and allows a greater percentage of its energy to be converted into electricity. These systems are designed primarily for large scale centralised



**Figure 10.25 (a)** Example of a rooftop PV system. **(b)** A schematic concentrating PV system, where a large number of mirrors focus sunlight onto central PV receivers

**Source:** CERP, Wikimedia Commons; Energy Innovations Inc. under Wikipedia licence cc-by-sa-2.5

power, due to the complexities of the receivers. Concentrating PV is the most efficient form of PV, delivering a typical system efficiency of around 20 per cent, and has achieved efficiencies of just over 40 per cent in ideal laboratory conditions (NREL 2008).

An advantage of using concentrating PV is that it reduces the area of solar cells needed to capture the sunlight. PV cells are often expensive to produce, and the mirrors or lenses used to concentrate the light are generally cheaper than the cells. However, the use of solar concentrators generally requires a larger system that cannot be scaled down as easily as flat-plate PV cells.

A relatively recent area of growth for PV applications is in Building-integrated PV (BIPV) systems. BIPV systems incorporate PV technology into many different components of a new building. These components include rooftops, walls and windows,

where PV cells can either replace, or be integrated with existing materials. BIPV has the potential to reduce costs of PV systems, and to increase the surface area available for capturing solar energy within a building (NREL 2009b).

#### *Efficiency of photovoltaic systems*

Currently, the maximum efficiency of commercially available PV modules is around 20 to 25 per cent, with efficiencies of around 40 per cent achieved in laboratories. Most commercially available PV systems have an average conversion efficiency of around 10 per cent. New developments (such as multi-junction tandem cells) suggest solar cells with conversion efficiencies of greater than 40 per cent could become commercially available in the future. Fthenakis et al. (2009) posit that increases in efficiency of PV modules will come from further technology improvements.

### BOX 10.2 SOLAR ENERGY TECHNOLOGIES FOR DIRECT-USE APPLICATIONS

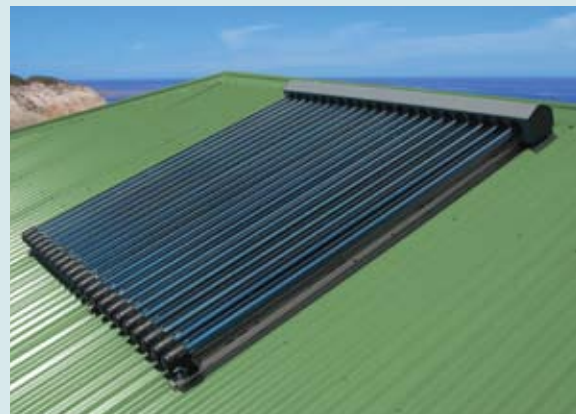
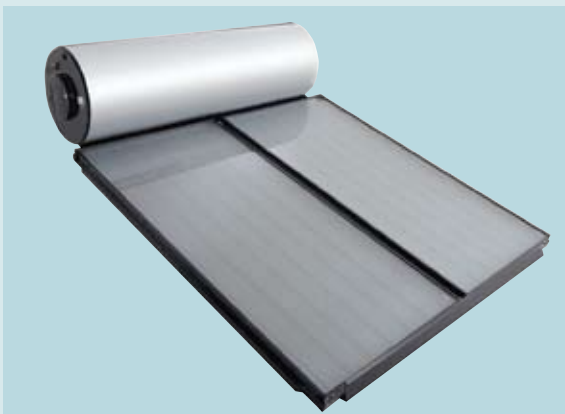
#### *Solar thermal heating*

Solar thermal heating uses direct heat from sunlight, without the need to convert the energy into electricity. The simplest form of solar thermal heating is achieved simply by pumping water through a system of light-absorbing tubes, usually mounted on a rooftop. The tubes absorb sunlight, and heat the water flowing within them. The most common use for solar thermal heating is hot water systems, but they are also used for swimming pool heating or space heating.

There are two main types of solar water heaters: flat-plate and evacuated tube systems (figure 10.26). Flat-plate systems are the most widespread and mature technology. They use an array of very small tubes, covered by a transparent glazing for insulation. Evacuated tubes consist of a sunlight absorbing metal tube, inside two concentric transparent glass tubes. The space between the two glass tubes is

evacuated to prevent losses due to convection. Evacuated tubes have lower heat losses than flat plate collectors, giving them an advantage in winter conditions. However, flat-plate systems are generally cheaper, due to their relative commercial maturity.

Solar thermal heating is a mature technology and relatively inexpensive compared to other solar technologies. This cost advantage has meant that solar thermal heating has the largest energy production of any solar technology. In some countries with favourable sunlight conditions, solar water heaters have gained a substantial market share of water heaters. For example, the proportion of households with solar water heaters in the Northern Territory was 54 per cent in 2008 (CEC 2009) whereas in Israel this proportion is approximately 90 per cent (CSIRO 2010).



**Figure 10.26** (a) Flat-plate solar water heater. (b) Evacuated tube solar water heater

**Source:** Western Australian Sustainable Energy Development Office 2009; Hills Solar (Solar Solutions for Life) 2009



### Solar air conditioning

Solar thermal energy can also be used to drive air-conditioning systems. Sorption cooling uses a heat source to drive a refrigeration cycle, and can be integrated with solar thermal heat collectors to provide solar air-conditioning. Since sunlight is generally strong when air-conditioning is most needed, solar air-conditioning can be used to balance peak summer electricity loads. However, a number of developments are required before solar air-conditioning becomes cost competitive in Australia (CSIRO 2010).

### Passive solar heating

Solar energy can also be used to heat buildings directly, through designing buildings that capture sunlight and store heat that can be used at night. This process is called passive solar heating, and can save energy (electricity and gas) that would otherwise be needed to heat buildings during cold weather. New buildings can be constructed with passive solar heating features at minimal extra cost, providing a reliable source of heating that can greatly reduce energy demands in winter (AZSC 2009).

Passive solar heating usually requires two

basic elements: a north-facing (in the Southern Hemisphere) window of transparent material that allows sunlight to enter the building; and a thermal storage material that absorbs and stores heat. Passive solar heating must also be integrated with insulation to provide efficient storage of heat, and roof designs that can maximise exposure in winter, and minimise exposure in summer. Although some of these features can be retrofitted to existing buildings, the best prospects for passive solar heating are in the design of new buildings.

### Combined heat and power systems

A technology under development in Australia and overseas is the combined heat and power system, combining solar thermal heating with PV technology (ANU 2009). Typically this consists of a small-scale concentrating parabolic trough system with a central PV receiver, where the receiver is coupled to a cooling fluid. While the PV produces electricity, heat is extracted from the cooling fluid and can be used in the same way as a conventional solar thermal heater. These systems can achieve a greater efficiency of energy conversion, by using the same sunlight for two purposes. These systems are being targeted for small-scale rooftop applications.

Electricity generation from solar energy is projected to increase strongly, from only 0.1 TWh in 2007–08 to 4 TWh in 2029–30, representing an average annual growth rate of 17.4 per cent (figure 10.28). The share of solar energy in electricity generation is also projected to increase, from 0.04 per cent in 2007–08 to 1 per cent in 2029–30.

While high investment costs currently represent a barrier to more widespread use of solar energy, there is considerable scope for the cost of solar technologies to decline significantly over time. The competitiveness of solar energy will also depend on government policies. The RET, the results of RD&D

programs and the proposed emissions reduction target are all expected to underpin the growth of solar energy over the outlook period.

### Proposed development projects

As at October 2009, there were no solar projects nearing completion in Australia (table 10.5). There are currently five proposed solar projects, with a combined capacity of 116 MW. The largest of these projects is Wizard Power's \$355 million Whyalla Solar Oasis, which will be located in South Australia. The project is expected to have a capacity of 80 MW and is scheduled to be completed by 2012.

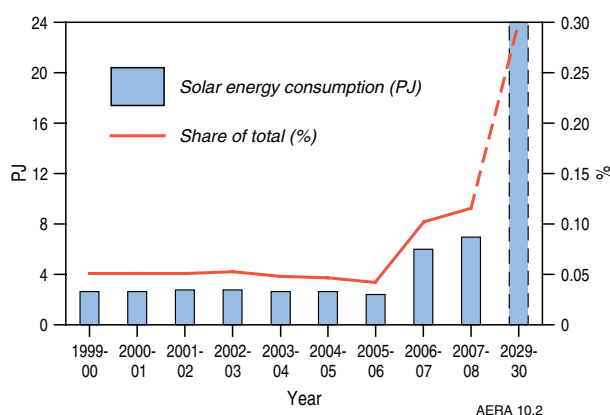


Figure 10.27 Projected primary energy consumption of solar energy

Source: ABARE 2009a, 2010

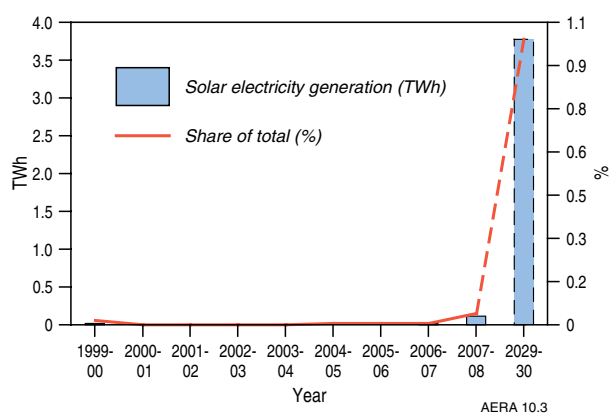


Figure 10.28 Projected electricity generation from solar energy

Source: ABARE 2009a, 2010

**Table 10.4** Outlook for Australia's solar market to 2029–30

	unit	2007–08	2029–30
<b>Primary energy consumption</b>	PJ	7	24
Share of total	%	0.1	0.3
Average annual growth, 2007–08 to 2029–30	%		5.9
<b>Electricity generation</b>			
Electricity output	TWh	0.1	4
Share of total	%	0.04	1.0
Average annual growth, 2007–08 to 2029–30	%		17.4

**a** Energy production and primary energy consumption are identical  
**Source:** ABARE 2009a, 2010

**Table 10.5** Proposed solar energy projects

Project	Company	Location	Status	Start up	Capacity	Capital expenditure
SolarGas One	CSIRO and Qld Government	Qld	Government grant received	2012	1MW	na
Lake Cargelligo solar thermal project	Lloyd Energy Systems	Lake Cargelligo, NSW	Government grant received	na	3MW	na
Cloncurry solar thermal power station	Lloyd Energy Systems	Cloncurry, Qld	Government grant received	2010	10MW	\$31m
ACT solar power plant	ACT Government	To be determined, ACT	Pre-feasibility study completed	2012	22MW	\$141m
Whyalla Solar Oasis	Wizard Power	Whyalla, SA	Feasibility study under way	2012	80MW	\$355 m

**Source:** ABARE 2009c; Lloyd Energy Systems 2007

## 10.5 References

ABARE (Australian Bureau of Agricultural and Resource Economics), 2010, Australian energy projections to 2029–30, ABARE research report 10.02, prepared for the Department of Resources, Energy and Tourism, Canberra

ABARE, 2009a, Australian Energy Statistics, Canberra, August

ABARE, 2009b, Electricity generation: Major development projects – October 2009 listing, Canberra, November

AER (Australian Energy Regulator), 2008, State of the Energy Market 2008, <<http://www.aer.gov.au/content/index.phtml/itemId/723386>>

Ausra, 2009, The Liddell Solar Thermal Power Station, <<http://www.ausra.com/pdfs/LiddellOverview.pdf>>

ANU (Australian National University), 2009a, Solar Thermal Energy Research, <<http://solar-thermal.anu.edu.au/pages/DownloadPics.php>>

ANU, 2009b, Combined Heat and Power Solar (CHAPS) Concentrator System, <[http://solar.anu.edu.au/projects/chaps\\_proj.php](http://solar.anu.edu.au/projects/chaps_proj.php)>

AZSC (Arizona Solar Center), 2009, Passive Solar Heating and Cooling, <<http://www.azsolarcenter.com/technology/pas-2.html>>

Begay-Campbell S, 2008, Concentrating Solar Technologies and Applications: Sandia National Laboratories, <[http://apps1.eere.energy.gov/tribalenergy/pdfs/course\\_tcd0801\\_ca17ax.pdf](http://apps1.eere.energy.gov/tribalenergy/pdfs/course_tcd0801_ca17ax.pdf)>

BIS Shrapnel, 2008, Hot water systems installed in new

dwellings in Australia, North Sydney, <[http://www.bis.com.au/reports/hot\\_water\\_systems\\_nd\\_in\\_aust.html](http://www.bis.com.au/reports/hot_water_systems_nd_in_aust.html)>

Borenstein S, 2008, The Market Value and Cost of Solar Photovoltaic Electricity Production, Centre for the Study of Energy Markets, University of California

Bureau of Meteorology, 2009, Average Daily Solar Exposure, <[http://www.bom.gov.au/climate/averages/climatology/solar\\_radiation/IDCJCM0019\\_solar\\_exposure.shtml](http://www.bom.gov.au/climate/averages/climatology/solar_radiation/IDCJCM0019_solar_exposure.shtml)>

CEC (Clean Energy Council), 2009, Solar Industry Snapshot, <[http://www.bcse.or.au/cec/resourcecentre/reports/mainColumnParagraphs/00/text\\_files/file15/CEC%20Solar%20Sheet\\_revised\\_2.pdf](http://www.bcse.or.au/cec/resourcecentre/reports/mainColumnParagraphs/00/text_files/file15/CEC%20Solar%20Sheet_revised_2.pdf)>

Climate Action Newcastle, 2009, Newcastle's Going Solar, <[http://www.climateaction.org.au/files/images/solar%20panel%20photo\\_0.jpg](http://www.climateaction.org.au/files/images/solar%20panel%20photo_0.jpg)>

CSIRO, 2010, Energy technology in Australia: overview and prospects for the future, A report for the Department of Resources, Energy and Tourism, Canberra (forthcoming)

DESERTEC, 2009, Clean Power From Deserts. Whitebook 4th Edition, <<http://www.desertec.org/en/concept/whitebook/>>

Desertec-UK, 2009, Concentrating Solar Thermal Power, <[http://www.trec-uk.org.uk/images/schott\\_parabolic\\_trough.jpg](http://www.trec-uk.org.uk/images/schott_parabolic_trough.jpg)>

DEWHA (Department of Environment, Water, Heritage and the Arts), 2009, Solar homes and communities plan website, <<http://www.environment.gov.au/settlements/renewable/pv/index.html>>

EIA (Energy Information Administration of the United States), 2009, International Energy Outlook 2009, Washington DC

- Enviromission, 2009, Technology Overview, <[http://www.enviromission.com.au/EVM/content/technology\\_technologyover.html](http://www.enviromission.com.au/EVM/content/technology_technologyover.html)>
- EPIA (European Photovoltaic Industry Association), 2009, Global Market Outlook for Photovoltaics Until 2013, <<http://www.epia.org/publications/epia-publications.html>>
- Fthenakis V, Mason JE and Zweibel K, 2009, The technical, geographical, and economic feasibility for solar energy to supply the energy needs of the US, Energy Policy, vol 37, no 2, 387–399
- Geoscience Australia, 2009, Renewable Energy Power Stations, <[http://www.ga.gov.au/renewable/operating/operating\\_renewable.xls](http://www.ga.gov.au/renewable/operating/operating_renewable.xls)>
- Greenpeace, 2009, Concentrating Solar Power, Global Outlook 09, <<http://www.greenpeace.org/international/press/reports/concentrating-solar-power-2009>>
- IEA (International Energy Agency), 2003, Greenhouse Gas Research and Development Programme – The potential of solar electricity to reduce CO<sub>2</sub> emissions, Paris
- IEA, 2009a, World Energy Outlook 2009, Paris
- IEA, 2009b, World Energy Balances, 2009, Paris
- IEA-PVPS, 2008, Trends in Photovoltaic Applications: Survey report of selected IEA countries between 1992 and 2007, IEA Photovoltaic Power Systems Programme
- Jiaying Dyi Solar Energy Co, 2009, Solar Water Heater-1, <<http://jxdyiy.en.made-in-china.com/product/sqdnACbhfQDM/China-Flat-Solar-Water-Heater-1.html>>
- Jones J, 2008, Concentrating Solar Thermal Power, Renewable Energy World Magazine
- Lloyd Energy Systems, 2007, Cloncurry Solar Thermal Storage Project, <<http://www.lloydenergy.com/presentations/Cloncurry%20Solar%20Thermal%20Storage%20Project.pdf>>
- Lorenz P, Pinner D and Seitz T, 2008, The Economics of Solar Power. The McKinsey Quarterly, June 2008
- Lovegrove K and Dennis M, 2006, Solar thermal energy systems in Australia. International Journal of Environmental Studies. 63 (6): 791–802
- MacKay DJC, 2009, Sustainable Energy – Without the Hot Air. UIT, Cambridge, <<http://www.withouthotair.com/>>
- McKinsey & Company, 2008, The Economics of Solar Power, in McKinsey Quarterly, June 2008, <<http://www.mckinseyquarterly.com>>
- Mills D, Morrison G and Le Lievre P, 2002, Project Proposal for a Compact Linear Fresnel Reflector Solar Thermal Plant in the Hunter Valley, <[http://solar1.mech.unsw.edu.au/glm/papers/Mills\\_projectproposal\\_newcastle.pdf](http://solar1.mech.unsw.edu.au/glm/papers/Mills_projectproposal_newcastle.pdf)>
- National Aeronautics and Space Administration (NASA), 2009, Surface Meteorology and Solar Energy Dataset, <<http://eosweb.larc.nasa.gov/sse>>
- NREL, 2009a, Photographic Information Exchange, <<http://www.nrel.gov/data/pix/searchpix.html>>
- NREL, 2009b, Photovoltaic Research – Building-Integrated PV, <[http://www.nrel.gov/pv/building\\_integrated\\_pv.html](http://www.nrel.gov/pv/building_integrated_pv.html)>
- Prowse R, 2009, Personal communication, 5/6/2009. Centre Manager, Centre for Sustainable Energy Systems, Australian National University
- RET (Department of Resources, Energy and Tourism), 2009a, Australian Solar Institute Fact Sheet, <<http://www.ret.gov.au/energy/Documents/ASI%20Fact%20sheet%2014Jan%20cleared%20by%20MO.pdf>>
- RET, 2009b, Solar Flagships Program Fact Sheet, <<http://www.ret.gov.au/energy/Documents/Solar%20Flagships%20factsheet%20-%20Oct%202009.pdf>>
- Sandia, 2009, Lab Accomplishments 2009: Sandia National Laboratories, <[http://www.sandia.gov/LabNews/labs-accomplish/2009/lab\\_accomplish-2009.pdf](http://www.sandia.gov/LabNews/labs-accomplish/2009/lab_accomplish-2009.pdf)>
- SEGS, 2009, Solar Electricity Generating Systems website, <[http://www.flagsol.com/SEGS\\_tech.htm](http://www.flagsol.com/SEGS_tech.htm)>
- Sellsius, 2006, The World's Most Efficient Solar Energy, <<http://blog.sellsiusrealestate.com/technology/the-worlds-most-efficient-solar-energy/2006/08/06/>>
- Solar Systems, 2009, 154 MW Victorian Project, <<http://www.solarsystems.com.au/154MWVictorianProject.html>>
- Solar Tube Company, 2009, Solar Water Heating System, <<http://www.solartubecompany.co.uk/solar-water-heating/>>
- Stein W, 2009a, personal communication, 4/8/2009. Manager, National Solar Energy Centre, CSIRO Division of Energy Technology
- Stein W, 2009b, personal communication, 3/11/2009. Manager, National Solar Energy Centre, CSIRO Division of Energy Technology
- Sunwize Technologies, 2008, SunWize World Insolation Map, <[http://www.sunwize.com/info\\_center/solar-insolation-map.php](http://www.sunwize.com/info_center/solar-insolation-map.php)>
- Watt M, 2009, National Survey Report of PV Power Applications in Australia 2008: Australian PV Association
- WEC (World Energy Council), 2007, Survey of Energy Resources 2007, London, September 2007, <[http://www.worldenergy.org/publications/survey\\_of\\_energy\\_resources\\_2007/default.asp](http://www.worldenergy.org/publications/survey_of_energy_resources_2007/default.asp)>
- WEC, 2009, Survey of energy resources: Interim update 2009. London, July 2009, <[http://www.worldenergy.org/publications/survey\\_of\\_energy\\_resources\\_interim\\_update\\_2009/default.asp](http://www.worldenergy.org/publications/survey_of_energy_resources_interim_update_2009/default.asp)>
- Wyld Group and MMA, 2008, High Temperature Solar Thermal Technology Roadmap. Prepared for the NSW and Victorian Governments by Wyld Group and McLennan Magasanik Associates, <[http://www.coag.gov.au/reports/docs/HTSolar\\_thermal\\_roadmap.pdf](http://www.coag.gov.au/reports/docs/HTSolar_thermal_roadmap.pdf)>

# Chapter 11

## Ocean Energy



### 11.1 Summary

#### KEY MESSAGES

- Ocean energy – wave, tide and ocean thermal energy sources – is an underdeveloped but potentially substantial renewable energy source.
- Australia has world-class wave energy resources along its western and southern coastline, especially in Tasmania.
- Australia's best tidal energy resources are located along the northern margin, especially the north-west coast of Western Australia.
- Worldwide, ocean energy accounts for a negligible proportion of total electricity generation. The share of ocean energy in world electricity generation is projected to increase by 2030, albeit only modestly.
- Current ocean energy use is mainly based on tidal power stations. Wave energy technologies are at early stages of commercialisation and ocean thermal technologies are still at development stage.
- Adoption of ocean energy in Australia depends on technologies for tidal or wave energy proving commercially viable. The cost of access to the transmission grid may also be an impediment for many sites.

#### 11.1.1 World ocean energy resources and market

- There are substantial ocean (tidal, wave and ocean thermal) energy resources that have potential for zero or low emission electricity generation.
- Ocean energy industries are at an early stage of development, and they are currently the smallest contributors to world electricity generation. Commercial applications of ocean energy have been limited to tidal barrage power plants in two OECD countries, France (240 MW) and Canada (20 MW), but major new tidal barrage plants are under construction in the Republic of Korea.
- Government policies and falling investment costs are projected to be the main factors underpinning future growth in world ocean energy use. World electricity generation from ocean energy is projected by the IEA in the reference case to increase at an average annual rate of 14.6 per cent between 2007 and 2030.

#### 11.1.2 Australia's ocean energy resources

- The northern half of the Australian continental shelf has limited wave energy resources, but has sufficient tidal energy resources for local electricity production in many areas, particularly the Northwest Shelf, Darwin, Torres Strait and the southern Great Barrier Reef (figure 11.1).

- The southern half of the Australian continental shelf has world-class wave energy resources along most of the western and southern coastlines, particularly the west and southern coasts of Tasmania (figure 11.2). In contrast, tidal energy resources are limited in this region.
- Areas in the Pacific Ocean are prospective for ocean thermal energy.

#### 11.1.3 Key factors in utilising Australia's ocean energy resources

- Production costs for ocean energy systems are currently high, but are expected to fall as technologies mature. The production costs of ocean energy technologies are estimated by the IEA to range from US\$60 per kW to US\$300 per kW (in 2005 dollars), with tidal barrage systems at the lower end of this range and tidal current and wave systems at the higher end.
- Given the largely pre-commercial status of the current ocean energy systems, the outlook is highly dependent on research, development and demonstration (RD&D) activities and the outcomes of these activities, both in assessing energy potential and developing low-cost energy conversion technologies.
- Government policies that encourage RD&D will be an important driver of the future development of ocean energy technologies in Australia.

- Many of Australia's best tidal and wave energy resources are in areas distant from the electricity grid. The proximity of the resource to major population centres and the electricity grid appears to be somewhat better for wave energy than tidal or ocean thermal energy.
- Some of Australia's best tidal energy resources are also located in environmentally sensitive areas and there are significant environmental impacts associated with tidal energy systems.
- New tidal technologies based on the use of tidal currents have environmental advantages over tidal barrage systems, but, like wave and ocean thermal energy systems, are still at an early stage of development.

#### 11.1.4 Australia's ocean energy market

- Ocean energy technologies are still at an early stage of development and have only been used at a pilot scale in Australia. Four tidal or wave energy plants, with a combined capacity of less than 1 MW, have been developed in recent years.
- There are also plans to develop several commercial scale tidal and wave energy

projects in Australia. If successful, these projects could lead to commercial scale plants generating electricity for the grid, for off-grid local domestic and industrial use, or to power water desalination plants.

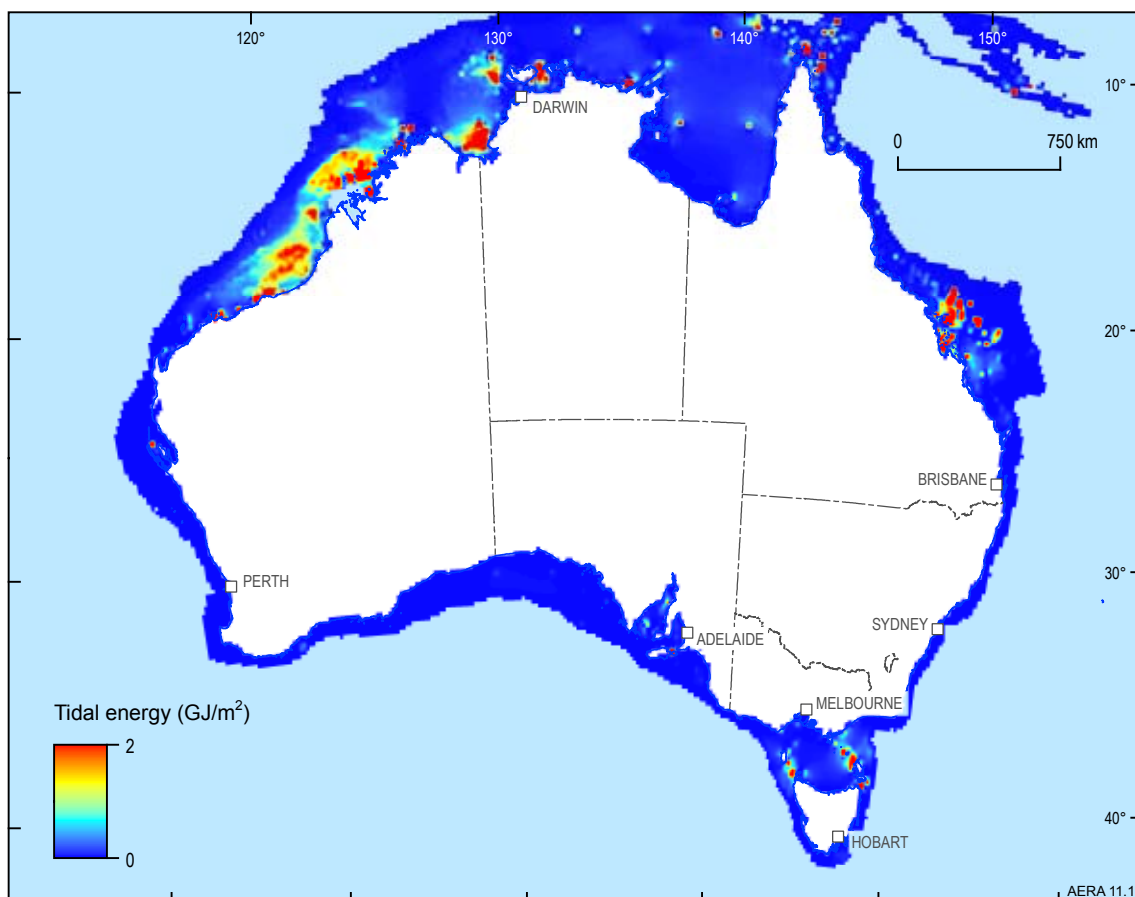
## 11.2 Background information and world market

### 11.2.1 Definitions

There are two broad types of ocean energy: mechanical energy from the tides and waves, and thermal energy from the sun's heat. In this report, ocean energy is classified as tidal energy, wave energy and ocean thermal energy. Potential energy resources associated with major ocean currents, such as the East Australia Current or the Leeuwin Current, are not considered here.

#### Tidal energy

**Tides** result from the gravitational attraction of the Earth-Moon-Sun system acting on the Earth's oceans. Tides are long period waves that result in the cyclical



**Figure 11.1** Total annual tide kinetic energy (in gigajoules per square metre, GJ/m<sup>2</sup>) on the Australian continental shelf (less than 300 m water depth)

**Note:** The low range of the colour scale is accentuated to show detail. The colour scale saturates at 2 GJ/m<sup>2</sup> but the maximum value present is 195 GJ/m<sup>2</sup>

**Source:** Geoscience Australia



rise and fall of the ocean's surface together with horizontal currents. The rotating tide waves result in different sea levels from one place on the continental shelf to the next at any one time, and this causes the water column to flow horizontally back and forth (tidal currents) over the shelf with the tidal oscillations in sea level.

**Tidal energy** is energy generated from tidal movements. Tides contain both potential energy, related to the vertical fluctuations in sea level, and kinetic energy, related to the horizontal motion of the water column. It can be harnessed using two main technologies:

- **Tidal barrages (or lagoons) are based on the rise and fall of the tides** – these generally consist of a barrage that encloses a large tidal basin. Water enters the basin through sluice gates in the barrage and is released through low-head turbines to generate electricity.
- **Tidal stream generators are based on tidal or marine currents** – these are free-standing structures built in channels, straits or on the shelf and are designed to harness the kinetic energy of the tide. They are essentially turbines

that generate electricity from horizontally flowing tidal currents (analogous to wind turbines).

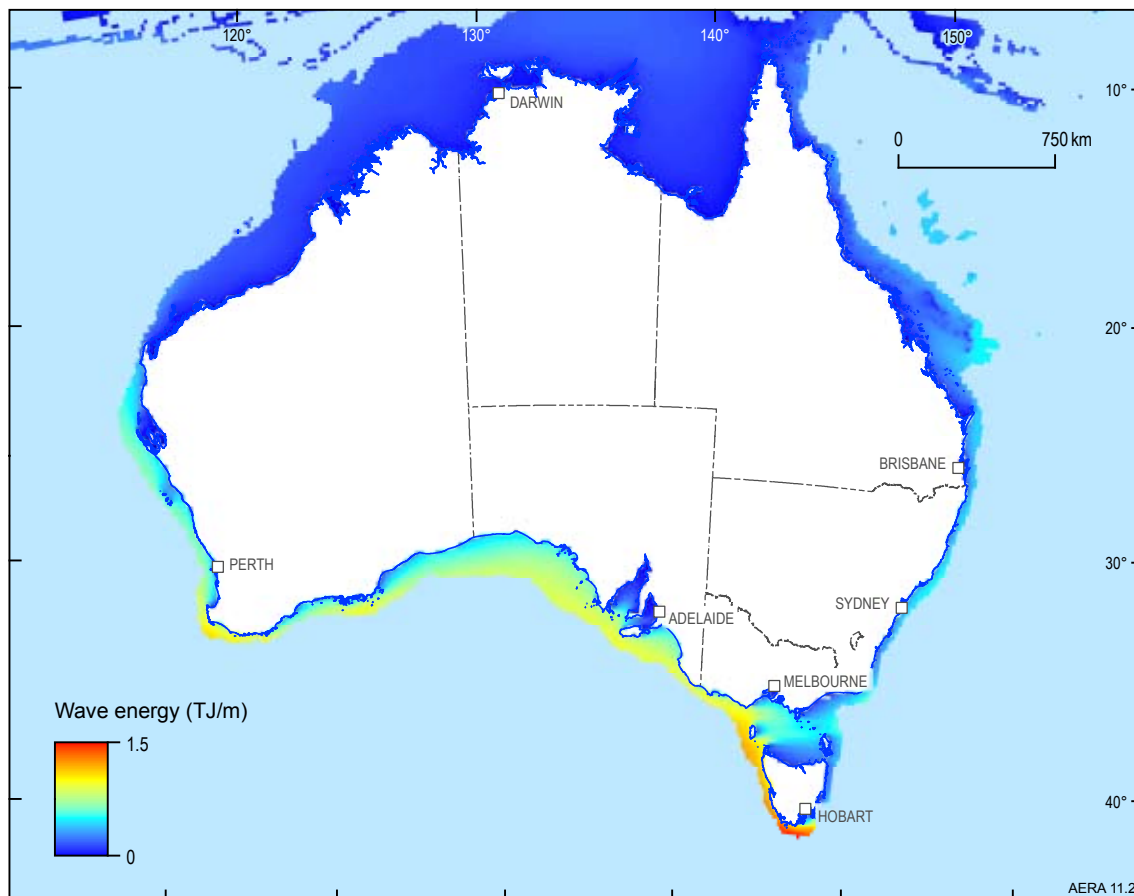
### Wave energy

**Waves (swell)** are formed by the transfer of energy from atmospheric motion (wind) to the ocean surface. Wave height is determined by wind speed, the length of time the wind has been blowing, the fetch (distance over which the wind has been blowing), and the depth and topography of the sea floor. Large storms generate local storm waves and more distant regular waves (swell) that can travel long distances before reaching shore.

**Wave energy** is generated by converting the energy of ocean waves (swells) into other forms of energy (currently only electricity). It can be harnessed using a variety of different technologies, several of which are currently being trialled to find the most efficient way to generate electricity from wave energy.

### Ocean thermal energy

Oceans cover more than 70 per cent of the Earth's surface. The sun's heat results in a temperature difference between the surface water of the ocean and deep ocean water, and this temperature difference creates ocean thermal energy.



**Figure 11.2** Total annual wave energy (in Terrajoules per metre, TJ/m) on the Australian continental shelf (less than 300 m water depth)

**Source:** Geoscience Australia

**Ocean thermal energy conversion (OTEC)** is a means of converting into useful energy the temperature difference between surface water and water at depth. OTEC plants may be used for a range of applications, including electricity generation. They may be land-based, floating or grazing.

More detailed information on tidal, wave and ocean thermal energy technologies is provided in Box 11.2 in section 11.4.

### 11.2.2 Ocean energy supply chain

Figure 11.3 provides a schematic representation of the potential tidal, wave and ocean thermal energy industry in Australia. Ocean energy resources have the potential to generate electricity using various types of turbines and other energy converters. The electricity generated could be used either locally, or fed into the electricity grid. As well as electricity generation, some ocean energy resources can be used for other purposes such as pumping seawater through desalination plants to generate potable water.

The supply of tidal, wave and ocean thermal energy requires firstly identifying the sites with the best energy resources matched to the energy converter technology being considered, so that their potential for generating electricity can be determined. Whether or not a potential project then proceeds to development will require detailed economic assessment, including factors such as the capital and operating costs, access to finance, the cost of grid connection, if relevant, including transmission distances and associated losses, environmental and community issues and the price received for the energy generated.

### 11.2.3 World ocean energy market

There is only a small market at present for tidal, wave and ocean thermal energy. In 2009, commercial applications were limited to electricity generation based on tidal energy resources in France and Canada but significant investment in new tidal energy projects was taking place in the Republic of Korea. Feasibility assessments and RD&D investments in ocean energy technologies are taking place in several countries.

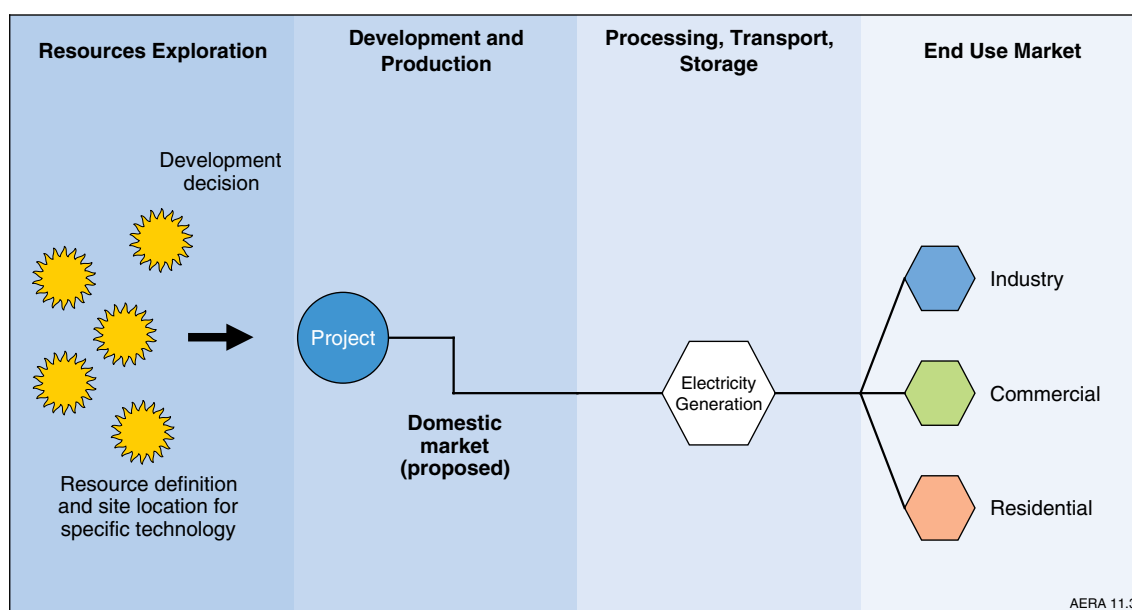
#### Resources

##### *Tidal energy*

The tidal energy resource is vast and sustainable. However, the economically exploitable resource is currently small because of the considerable costs associated with energy extraction and the environmental impacts of some tidal energy technologies, notably barrages and lagoons (tidal pools). There are few estimates of the world tidal energy resource potential.

##### *Wave energy*

The global wave power resource in deep water (100 m or more) has been estimated at 1–10 TW and the economically exploitable resource could be as high as 2000 TWh per year (WEC 2007). The average annual wave power across the world is shown in figure 11.4. Some of the coastlines with the greatest wave energy potential are the western and southern coasts of South America, South Africa and Australia. These coasts experience the waves generated by the westerly wind belt between latitudes 40° and 50° south, which are



**Figure 11.3** Australia's ocean energy supply chain

Source: ABARE and Geoscience Australia

blowing over an effectively infinite fetch. This produces some of the largest and most persistent wave energy levels globally.

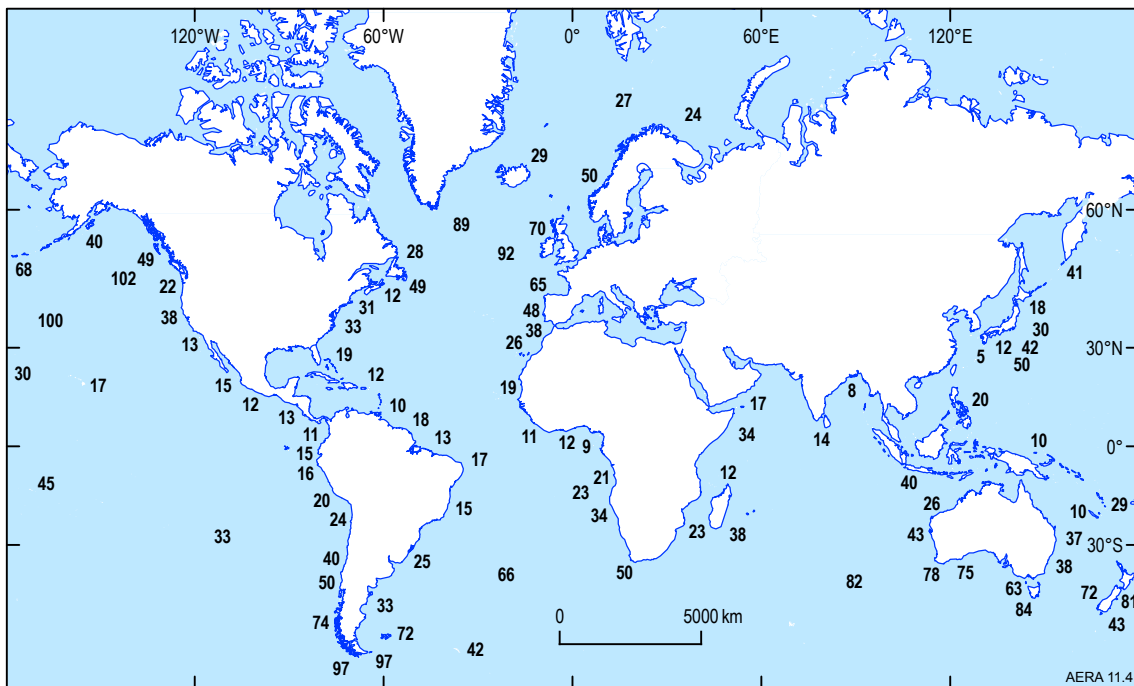
*Ocean thermal energy*

At present, it is not possible to quantify ocean thermal energy resource potential (WEC 2007). Figure 11.5 shows the temperature difference between the surface water of the oceans in tropical and subtropical areas, and water at a depth of around 1000 metres which is sourced from the polar regions (WEC 2007).

OTEC may be used in circumstances where there are temperature differences of at least 20°C.

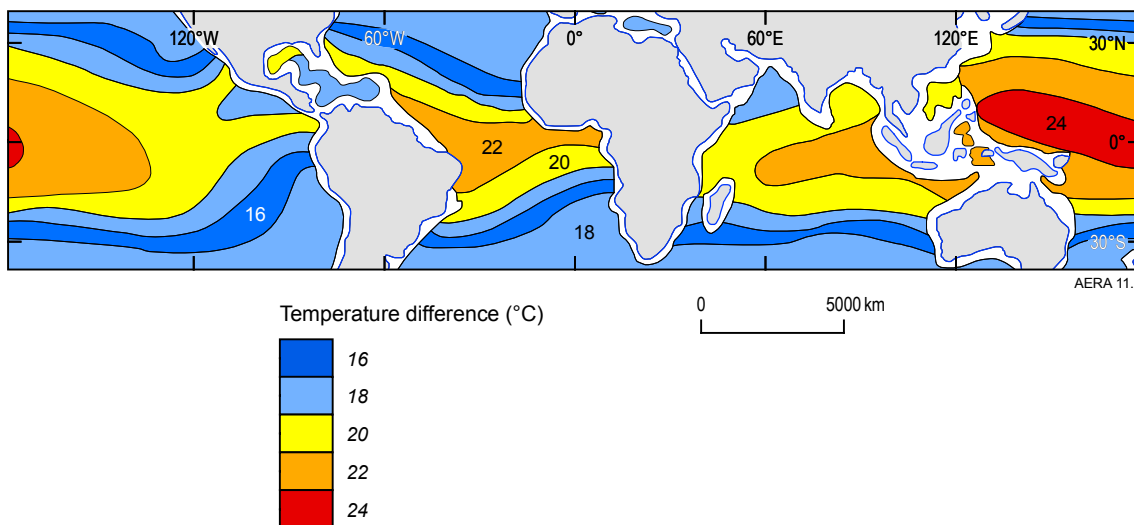
**Primary energy consumption**

Ocean energy is currently only used to generate electricity and hence primary energy consumption of ocean energy is the same as fuel inputs to electricity generation. World ocean energy use decreased at an average annual rate of 1.4 per cent between 2000 and 2008, and accounted for only a very small proportion of total primary energy consumption



**Figure 11.4** Average annual wave power levels (in kW/m)

Source: World Energy Council 2007



**Figure 11.5** The areas available for ocean thermal energy conversion (OTEC) and the temperature difference (measured in °C)

Source: World Energy Council 2007

(table 11.1). Tidal energy has been utilised on a commercial scale to date only in OECD countries.

### Electricity generation

In 2008, 544 GWh (0.5 TWh) of electricity was generated from ocean (tidal) energy, representing only 0.003 per cent of world electricity generation (figure 11.6). Ocean energy has been generated from tidal energy plants in France and Canada;

- France, the main ocean energy producing country, produced 1.8 PJ (512 GWh) commercially in 2007 and 2008. A 240 MW tidal barrage power plant has been operating at La Rance in France since 1966 and is currently the largest tidal power station in the world. It will be overtaken when the 260 GW

tidal energy power plant at Lake Sihwa, near Seoul, Republic of Korea is commissioned in 2010.

- Canada produced 0.1 PJ (35 GWh) in 2007 and 2008. Canada has a 20 MW tidal barrage power plant in Annapolis Royal, Nova Scotia, which has been operating since 1984.

Globally, there is significant RD&D activity that will contribute to the future commercialisation of other ocean energy technologies. Information on global RD&D activity is provided in section 11.4.

### World ocean energy market outlook

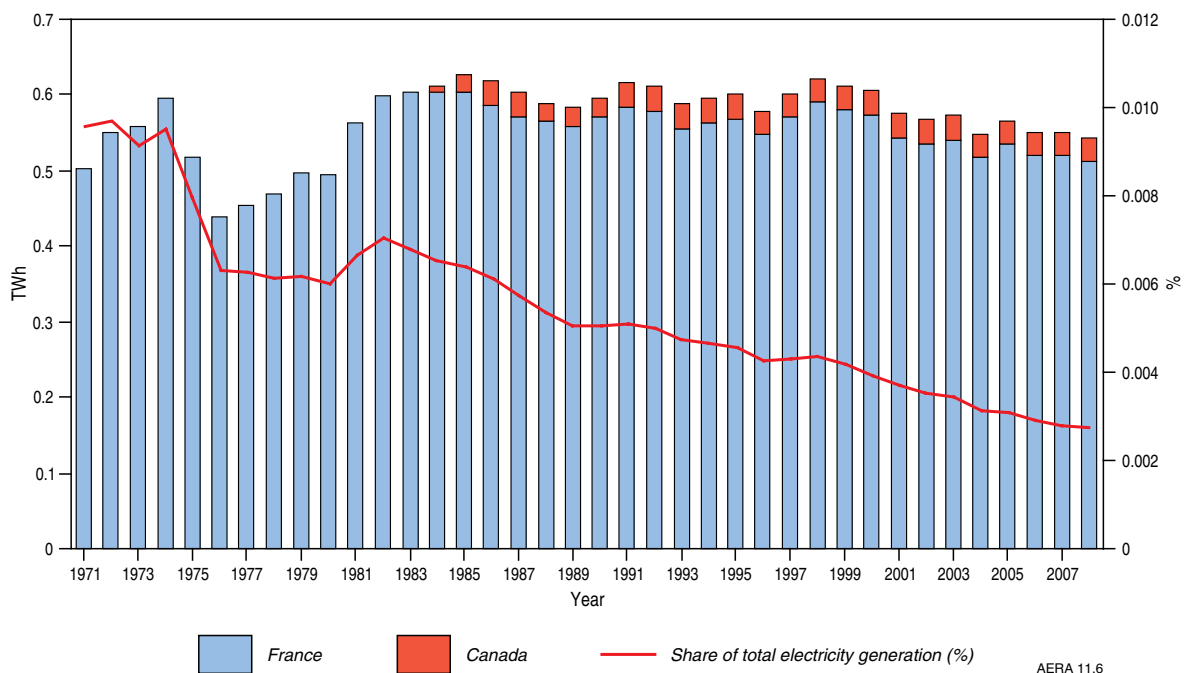
The IEA projects some growth in ocean energy production over the outlook period to 2030, although

**Table 11.1** Key ocean energy statistics

	unit	Australia 2007–08	OECD 2008	World 2008
<b>Primary energy consumption<sup>a</sup></b>	PJ	-	2.0	2.0
Share of total <sup>b</sup>	%	-	0.0009	0.0004
Average annual growth, 2000–2008	%	-	-1.3	-1.4
<b>Electricity generation</b>				
Electricity output	TWh	-	0.5	0.5
Share of total <sup>b</sup>	%	-	0.005	0.003
Electricity capacity	GW	0.0008	0.261	0.261

**a** Energy production and primary energy consumption are identical **b** Total world primary energy consumption and electricity generation data are for 2007

Source: IEA 2009a



**Figure 11.6** World wave and tidal electricity generation and share of total electricity generation

Source: IEA 2009a

it is projected to remain the smallest supplier of electricity. In 2030, ocean energy is projected to account for 0.1 per cent of OECD electricity generation and 0.04 per cent of total world electricity generation (table 11.2).

Most of the growth is projected to occur in the European Union, which is projected to account for almost 70 per cent of total ocean energy use in 2030. A further 3 TWh is projected to be generated in small quantities in the United States, Canada and the Pacific. Tidal projects currently under development in the Republic of Korea are planned to be producing 550 GWh in 2010 with potential to increase significantly beyond that toward the Korean government's goal of producing 5 TWh using tidal power by 2020 (IEA 2009b).

**Table 11.2** IEA reference case projections for world ocean energy electricity generation

	unit	2007	2030
<b>OECD</b>	TWh	1	12
Share of total	%	0.009	0.091
Average annual growth	%	-	14.3
<b>Non-OECD</b>	TWh	0.0	1
Share of total	%	0.000	0.005
Average annual growth	%	-	-
<b>World</b>	TWh	1	13
Share of total	%	0.005	0.038
Average annual growth	%	-	14.6

Source: IEA 2009b

## 11.3 Australia's ocean energy resources and market

### 11.3.1 Ocean energy resources

The following discussion focuses on Australia's tidal energy and wave energy resources. There has been limited progress in assessing Australia's ocean thermal energy resources, not least because of the greater prospectivity of other renewable energy resources (WEC 2007).

#### Tidal energy

Assessment of Australia's tidal energy resources is restricted to the tide kinetic energy present on Australia's continental shelf. Tidal currents off the shelf are minimal. Moreover, significant transmission losses would be expected for tidal energy converters located far from shore. The continental shelf for this assessment is defined as water depths less than 300 m. Details of the data and methods used in this assessment and its limitations are described in Box 11.1.

Indicative values for the mean spring tide range around Australia are shown in figure 11.7. A variety of tide energy converters are presently available to generate

electricity. Barrage-type systems require specific coastal geomorphic settings – typically bays or estuaries – as they are designed to harvest the potential energy of the tide, which depends on both the tide range and the surface area of the basin (i.e. the tidal prism). Because of their site-specific requirements and the complex response of the tide in very shallow water, it is not practical to undertake a detailed national scale assessment of the tidal potential energy. Nevertheless, figure 11.1 identifies in broad terms the regions that may support tide energy converters of the barrage type, and therefore highlights where more site-specific studies could be directed.

Barrage-type tide energy systems generally require macro-tide ranges (greater than 4 m), which are restricted to the broad northern shelf of Australia; from Port Hedland northwards to Darwin and the southern end of the Great Barrier Reef. Other types of tidal energy converters (tidal turbines) harness the kinetic component of tide energy. They are suitable for installation on the continental shelf, and while they do not necessarily require highly-specific coastal configurations they can be deployed in locations where local coastal configurations result in increased tidal flows.

The total tidal kinetic energy on the entire Australian continental shelf at any one time, on average, is about 2.4 PJ. The total amount of tide kinetic energy on the shelf adjacent to each state is listed in Table 11.3. Since the tidal movement of shelf waters occupies the entire water column, the tide energy adjacent to each state at any one time reflects both the volume of shelf waters and the current speed of those waters. Table 11.3 provides some interesting comparisons, but it is skewed by the North West

**Table 11.3** Total tidal kinetic energy (on average at any one time on the continental shelf adjacent to each jurisdiction)

State/Territory	Total energy (TJ)
Northern Territory	311.63
Queensland	454.19
New South Wales	1.21
Victoria and Tasmania	151.41
South Australia	27.15
Western Australia	1496.33
<b>National Total</b>	<b>2441.92</b>

**Note:** These data were obtained by taking the time-average of the 1-year time series of tide kinetic energy density available at each grid point, multiplying by the water depth and multiplying by the area of a 0.1 degree by 0.1 degree quadrant at each grid point, and summing the results for all grid points across the shelf

Source: Geoscience Australia



Shelf region, where there is a large energy density due to the tide range and a large volume of water mobilised by the tide. There are numerous other locations on shallower or narrower regions of shelf where the total tide kinetic energy is considerably less, but still more than enough for the purpose of electricity generation (e.g. Darwin, Torres Strait and Bass Strait).

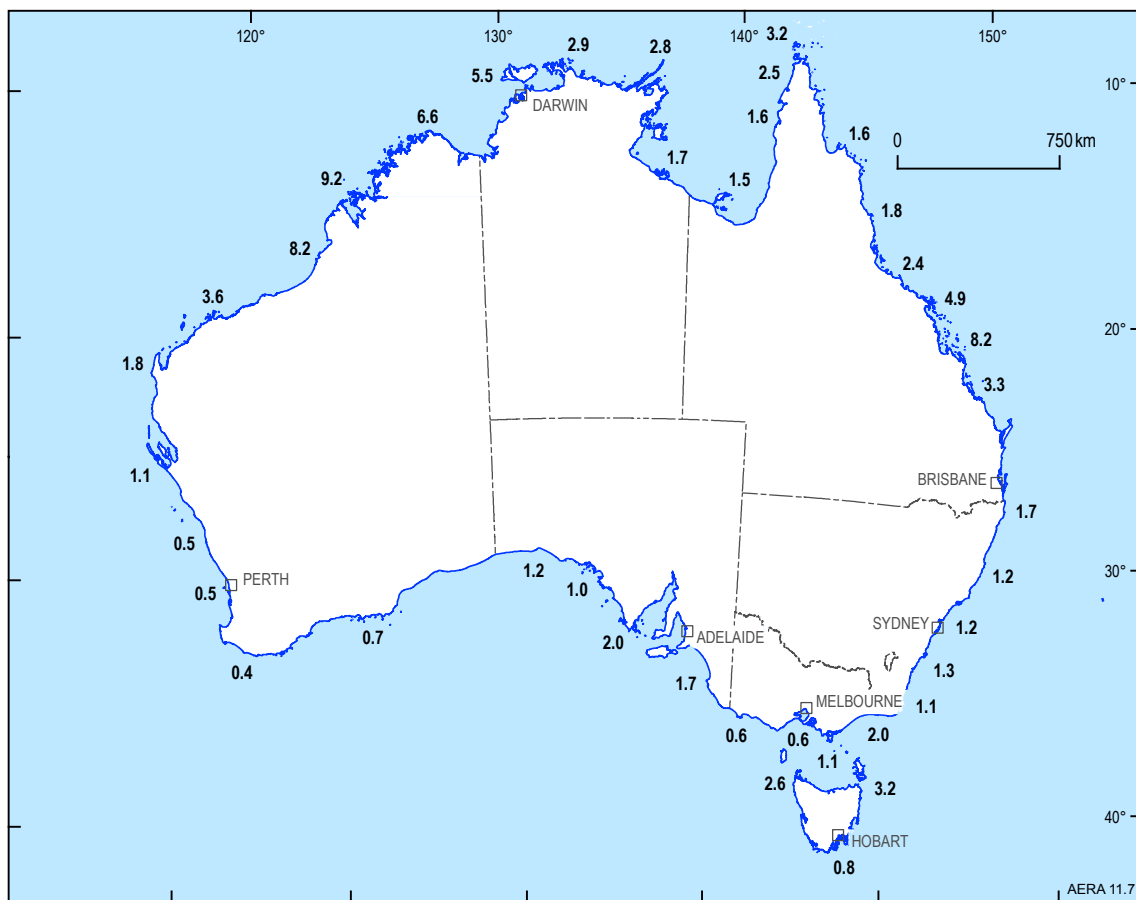
The spatial distribution of time-averaged tidal kinetic energy density on the Australian continental shelf is shown in figure 11.8. Consistent with the tide ranges shown in figure 11.7, the regions of shelf that have the largest kinetic energy densities are the North West Shelf and the southern shelf of the Great Barrier Reef, with large areas having densities of more than 100 Joules per cubic metre ( $J/m^3$ ). Darwin, Bass Strait and Torres Strait have localised areas with similar energy densities, despite more modest tide ranges (figure 11.8). This is due to the convergence and acceleration of tidal streams on the shelf between the islands and mainland.

The rate of delivery of tidal kinetic energy, or energy flux, is also referred to as *tidal (kinetic) power*. The spatial distribution of time-averaged tidal (kinetic)

power on the Australian continental shelf is shown in figure 11.9. Tidal (kinetic) power is also greatest on the northern half of the Australian continental shelf, with many areas having more than 100 Watts per square metre ( $W/m^2$ ). The southern half of the Australian shelf (with the exception of Bass Strait) has relatively little tidal kinetic energy or power (figures 11.8 and 11.9). The tidal kinetic energy delivered in a given time period, for example, in one year (total annual tidal kinetic energy), can be obtained by integrating the tidal (kinetic) power time series over one year.

The spatial distribution of total annual tide kinetic energy is shown in figure 11.10. This annual resource is expressed in  $GJ/m^2$  of tidal flow. In principle, the total annual tidal kinetic energy adjacent to each state could be estimated by integrating with respect to the cross-sectional area, but in practice the result depends on where the cross-section is drawn.

The estimated maximum time-average tidal (kinetic) power occurring on the shelf adjacent to each state is listed in table 11.4. The mean as well as the 10th, 50th, and 90th percentile power at that location is listed together with the total tidal kinetic



**Figure 11.7** Tide ranges (in metres) for the main standard ports around Australia

**Source:** Australian National Tide Tables; Australian Hydrographic Service

energy delivered annually. In all cases the maximum tidal power occurs in water depths less than or equal to 50 m, which in all likelihood is the depth range in which the present generation of tidal energy converters could be installed.

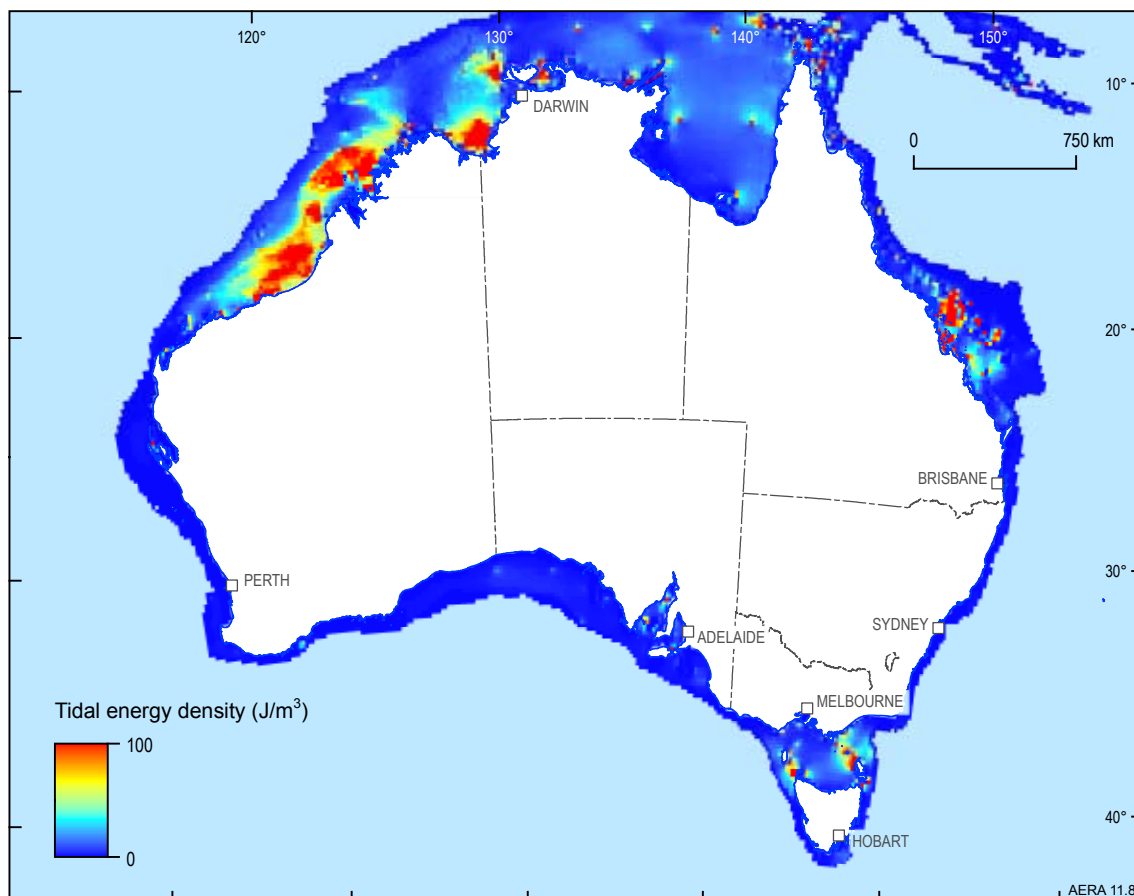
The best resourced jurisdictions are Western Australia, Queensland and the Northern Territory. Western Australia has locations off its coast where the average tidal (kinetic) power in water depths less than or equal to 50 m exceed 6.1 kW per square metre ( $\text{KW}/\text{m}^2$ ), delivering a total tidal kinetic energy of over  $195 \text{ GJ}/\text{m}^2$  annually.

### Wave energy

Previous studies of Australia's wave climate have focused mainly on the energetic south-western, southern and south-eastern margins of the continent, but there has been no previous publicly available comprehensive national assessment of Australia's wave energy resources. The wave energy resource assessment presented here is based on wave data hindcast by the Bureau of Meteorology at 6-hourly intervals over an eleven year period from 24 090 locations evenly distributed over Australia's entire

continental shelf (Hasselmann et al. 1988). The assessment methodology is described in more detail in Box 11.1.

Several types of wave energy converters are presently available to generate electricity. The choice of converter technology places limits on the locations from which wave energy can be harvested. For example, the Pelamis device is capable of generating electricity in water depths of 60 to 80 metres, whereas CETO is suited to shallower water depths (15 to 50 metres). Given these considerations, and the transmission losses expected if a wave energy converter is too far from shore, this resource assessment is restricted to the wave energy present on Australia's continental shelf. The shelf is defined here as water depths less than 300 metres. The spatial distribution of time-averaged wave energy density on the Australian continental shelf is shown in figure 11.11. The northern Australian shelf (i.e. above latitude 23 degrees south) is characterised by relatively low wave energy densities of generally less than  $2.5 \text{ kJ}/\text{m}^2$ . The southern Australian shelf, on the other hand, is characterised by energy



**Figure 11.8** Spatial distribution of time averaged tidal kinetic energy density on the Australian continental shelf (not depth integrated). The energy density at each location represents the average over any one year in  $\text{J}/\text{m}^3$ . Note that the colour scale saturates at  $100 \text{ J}/\text{m}^3$  to show detail; the maximum value present is  $2696 \text{ J}/\text{m}^3$

**Source:** Geoscience Australia

*Tidal energy*

There are no previous national assessments of Australia's tidal energy resource publicly available (although CSIRO's Marine and Atmospheric Research unit has work in progress). This assessment of Australia's tide energy resource is based on the mean spring tidal ranges calculated using the Australian National Tide Tables produced by the Australian Hydrographic Service (2006) together with the depth-averaged tidal current speed predicted using a hydrodynamic model. Tidal currents are one component of Geoscience Australia's GEOMACS Model (Geological and Oceanographic Model of Australia's Continental Shelf). A full description of the tide component of the model is presented in Porter-Smith et al. (2004).

Tidal water levels at a given site are highly predictable, provided more than a year of measurements is available. The tidal ranges presented in figure 11.7 are all from standard ports with long-term tide gauges installed, and are therefore considered sufficiently reliable for use in the resource assessment. The prediction of tidal water levels at sites where no tide gauge measurements exist is less straightforward. The accuracy then depends on the nature of the hydrodynamic model used and the complexity of the shelf and coastal bathymetry. Predictions of tidal currents are even more sensitive to these natural complexities. The hydrodynamic model used in this assessment to predict tidal current speeds, and ultimately tidal kinetic energy and power, provides reasonable, but at best approximate and as yet unsubstantiated, estimates of current speed on the shelf. However, it produces somewhat less adequate results in areas such as elongated coastal bays and in narrow seaways between islands and between islands and the mainland. The predictions for tidal kinetic energy and power in King Sound, Western Australia, for example, are small, yet this is where the largest tides in Australia occur (figure 11.11).

Overall, the tidal energy resource assessment presented here is acceptable as a first-estimate at the national scale. It indicates the relative importance of regions, but it cannot be considered accurate at a regional or local scale and it cannot be relied upon to any degree other than on the open shelf. There is a need to develop a new, national scale hydrodynamic model, based on the latest available national bathymetric grid and verified by satellite altimetry, oceanographic moorings, and tidal stream data. Regional scale hydrodynamic models suitable for elongate coastal bays and convoluted coastlines need to be developed for detailed site assessment.

*Wave energy*

The data used to undertake the wave energy resource assessment are wave conditions hindcast using the WAM Model – a third generation ocean wave prediction model (Hasselmann et al. 1988) – implemented by the Australian Bureau of

Meteorology. The hindcast wave data from the WAM model were converted to wave energy and power (energy flux) using linear wave theory for arbitrary depth. Details of the methods used are discussed in full in Hughes and Heap (2010). The Australian WAM model grid has a resolution of 0.1 degree and the resolution for significant wave height in the hindcast wave data is 0.1 metre. The accuracy varies with conditions, but is nominally 0.25 metre for wave heights in the range used for electricity generation. The resolution of the wave period is 0.1 second and the accuracy is nominally 1 second. This equates to a percentage range of uncertainty in the calculated wave energy density and power of 100 per cent or more for small wave heights (less than 1 metre), but decreasing rapidly to 17 per cent or less for larger wave heights (greater than 6 m). In essence, the percentage uncertainty is least for the southern half of Australia's continental shelf where the resource is of most promise.

The results of this assessment appear broadly consistent with those of a study of Australia's wave energy resource by RPS MetOcean for the Carnegie Corporation (now Carnegie Wave Energy Limited), an extract of which was published in the Corporation's 2008 Annual Report. The MetOcean wave energy resource assessment concluded that, on the southern half of Australia's shelf, there is an estimated resource of 525 000 MW in deep water and 171 000 MW in shallow water (a depth of less than 25 metres) (Carnegie Corporation 2008). The MetOcean rankings of each jurisdiction's resource are also consistent with the relative magnitudes of values in tables 11.5 to 11.6, but cannot be directly compared because their data are presented in different units of measurement.

Overall, the wave energy resource assessment presented here is considered to be sufficiently reliable as a national scale assessment. It is best suited to water depths greater than 25 m. In water depths less than 25 m the WAM model does not sufficiently account for shallow water processes (e.g. friction effects and refraction) that dissipate or redistribute the wave energy. Given that many of the current technologies are designed for deployment in water depths of 25 m or less, and some on the shoreline, a more refined assessment is warranted. This would involve:

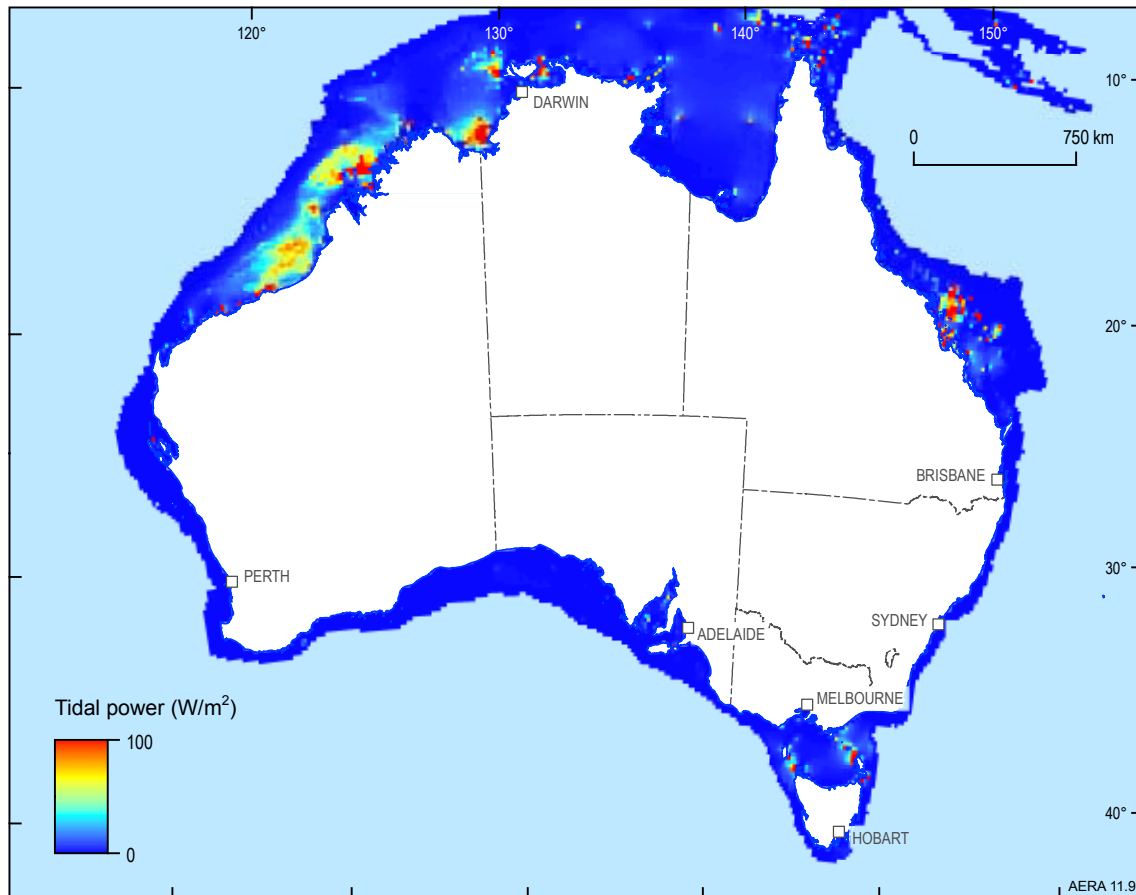
1. using the spatially limited waverider buoy data to verify/calibrate the WAM Model data, providing a more accurate data set with complete coverage of the shelf.
2. Integrating geographic information layers such as bathymetry, seabed type (gravel, sand, mud, reef), and coastal geomorphology into a GIS together with the wave climatology to identify the accessible resource. This integrated approach will have a strong influence on determining whether a site is suitable for a wave farm, irrespective of the wave climate.

densities of more than 2.5 kJ/m<sup>2</sup>, with large areas of the shelf experiencing twice this value (e.g. western and southern Tasmania). Much of the southern Australian coastline experiences significant wave heights (in excess of 1 m) virtually all of the time.

The total wave energy on the entire Australian continental shelf at any one time, on average, is about 3.47 PJ. The total amount of wave energy on the shelf adjacent to each state is listed in

table 11.5. The wave energy adjacent to each jurisdiction at any one time reflects both the area of shelf waters and the energy density in those waters. For example, Victoria and Tasmania have, on average, about the same total wave energy as the Northern Territory; however, it is concentrated in a smaller shelf area.

The shelf waters off Victoria and Tasmania are suitable sites for harvesting wave energy, whereas the shelf



**Figure 11.9** Spatial distribution of time-averaged tide (kinetic) power (W/m<sup>2</sup>) on the Australian continental shelf (not depth integrated). The (kinetic) power at each location represents a time-average over any one year. Note that the colour scale saturates at 100 W/m<sup>2</sup> to show detail; the maximum value present is 6179 W/m<sup>2</sup>

Source: Geoscience Australia

**Table 11.4** Mean and percentiles of tide (kinetic) power (W/m<sup>2</sup>) and total tide kinetic energy delivered annually (GJ/m<sup>2</sup>) on the continental shelf adjacent to each state

Jurisdiction	Power (W/m <sup>2</sup> )				Energy (GJ/m <sup>2</sup> )
	mean	10th percentile	50th percentile	90th percentile	
Northern Territory	2069.50	18.07	1029.68	5979.38	65.45
Queensland	4153.19	33.97	2316.85	10679.20	131.35
New South Wales	0.36	0.024	0.19	0.96	0.0011
Victoria and Tasmania	488.93	6.03	378.06	1193.56	15.46
South Australia	317.16	0.43	78.86	1014.65	10.03
Western Australia	6179.39	249.42	7529.65	10679.20	195.43

Source: Geoscience Australia

waters off the Northern Territory are not suitable, at least with existing technology. Consideration must also be given, however, to the rate at which useful energy can be delivered. In the case of tidal and wave energy resources, the lack of control over the timing, rate or level of delivery can impact significantly on their potential as an electricity source.

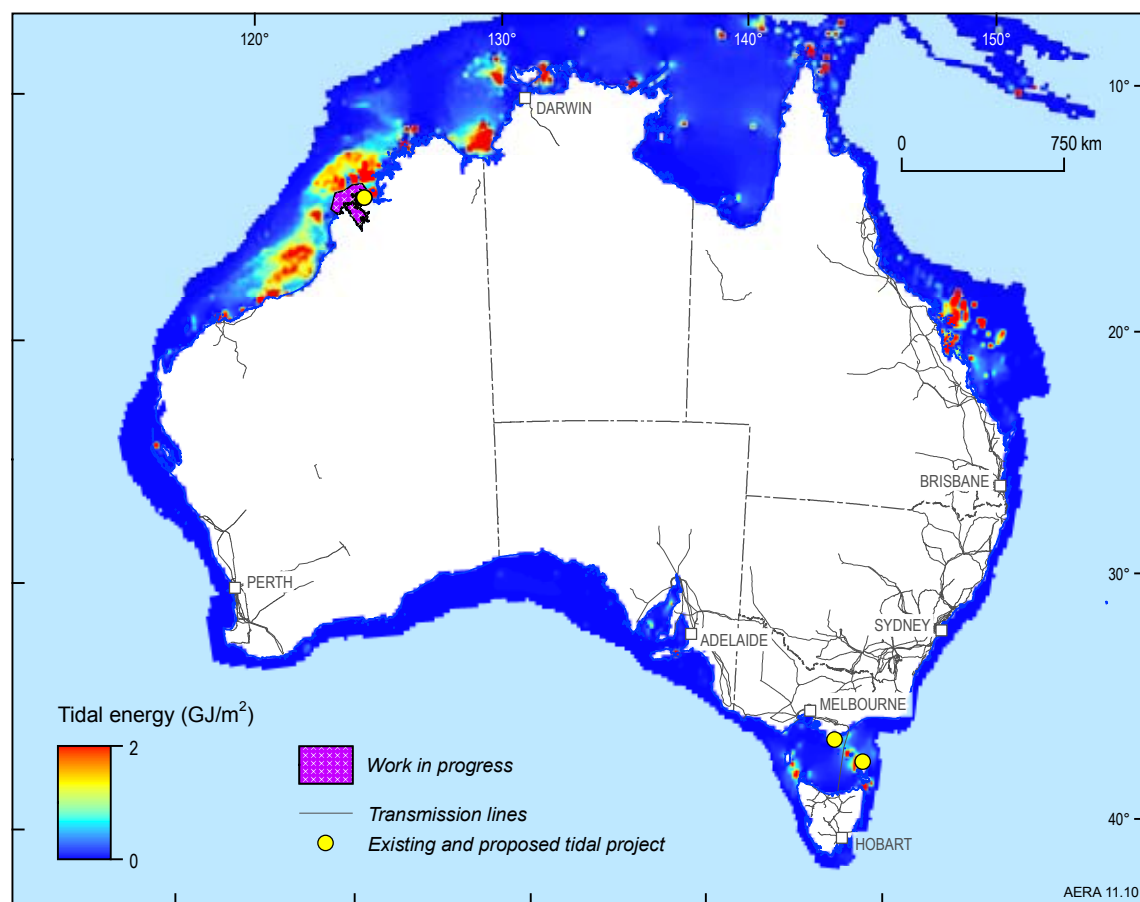
**Table 11.5** Total wave energy (on average at any one time) on the continental shelf adjacent to each state

Jurisdiction	Total energy (TJ)
Northern Territory	458.20
Queensland	805.04
New South Wales	69.53
Victoria and Tasmania	485.49
South Australia	631.62
Western Australia	1018.10
<b>National Total</b>	<b>3467.98</b>

**Note:** These data were obtained by taking the time-average of the 11-year time series of wave energy density available at each grid point, multiplying by the area of a 0.1 by 0.1 degree quadrant at each grid point, and summing the results for all grid points across the shelf  
**Source:** Geoscience Australia

The rate of delivery of wave energy, or energy flux, is also referred to as wave power. The spatial distribution of time-averaged wave power on the Australian continental shelf is shown in figure 11.12. Wave power is also greatest on the southern half of the Australian shelf, with 25–35 kW/m being common on the outer shelf. Despite the fact that there is a considerable amount of energy on the northern half of the Australian shelf at any one time due to the large shelf area (table 11.6), the energy density and power or rate that the energy is delivered is small (figures 11.11 and 11.12). For example, wave power off the Northern Territory shelf is typically less than 10 kW/m and unsuitable for harvesting with current technologies.

The spatial distribution of total annual wave energy (the total wave energy delivered in a year) is shown in figure 11.13. This annual resource (expressed in joules per metre), is the theoretical total annual wave energy available along a line orthogonal to the wave direction. In practice, the result depends on where



**Figure 11.10** Spatial distribution of total annual tide kinetic energy on the Australian continental shelf (less than 300 m water depth), with existing and proposed projects

**Note:** The kinetic energy at each location represents the total delivered in a year. Data obtained from a linearised, shallow tide model. The colour scale saturates at 2 GJ/m<sup>2</sup> to show detail; the maximum value present is 195 GJ/m<sup>2</sup>

**Source:** Geoscience Australia

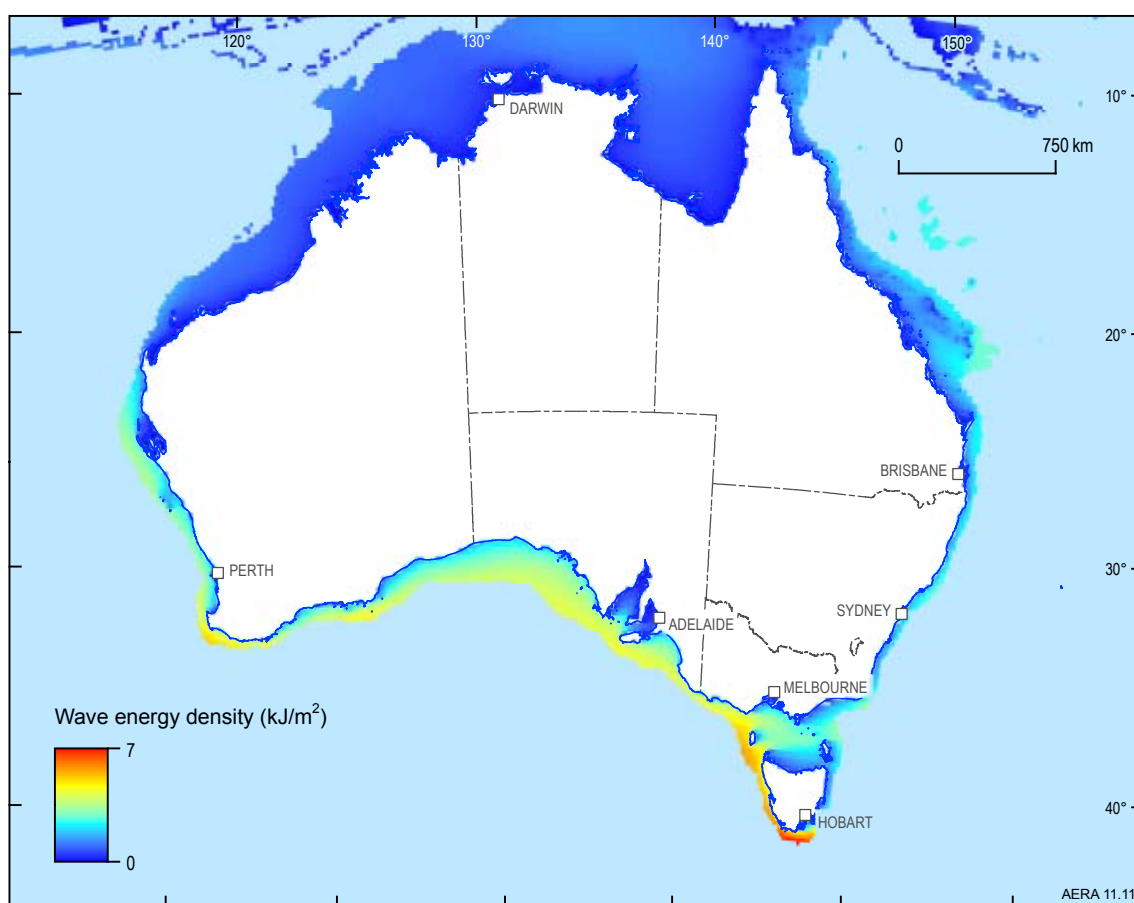


the line is drawn. Generally, the further offshore the line is drawn the greater the total energy resource available, because waves lose energy and power as they approach the coast.

The energy and power available for water depths less than or equal to 50 m (at which current generation energy converters predominate) are listed in table 11.6. Both the power and the total annual energy available in the less than or equal to 50 m depth range are generally slightly smaller than the total energy and power available in deeper water. The

differences between the two are more pronounced in New South Wales, Victoria and Tasmania.

On the basis of the assessment summarised in table 11.6, the states with the best wave energy resource are Western Australia, South Australia, Victoria and Tasmania. Tasmania is particularly well endowed with wave energy resources. There are locations off its coast where the average wave power in water depths less than or equal to 50 m reach almost 35 kW/m, delivering a total wave energy of 1100 GJ/m annually.



**Figure 11.11** Spatial distribution of time-averaged wave energy density on the Australian continental shelf, in  $\text{kJ/m}^2$ . The energy density at each location represents the average of the available 11-year time series from March 1997 to February 2008

**Source:** Geoscience Australia

**Table 11.6** Mean and percentiles of wave power ( $\text{kW/m}$ ) and total energy ( $\text{GJ/m}$ ) delivered annually in water depths equal to or less than 50 m

Jurisdiction	Power				Energy
	mean	10th percentile	50th percentile	90th percentile	mean
Northern Territory	5.32	0.33	2.68	13.09	167.90
Queensland	14.72	3.52	9.03	29.82	442.80
New South Wales	13.61	2.77	7.31	27.19	391.04
Victoria and Tasmania	34.87	4.88	18.22	70.66	1100.80
South Australia	25.51	4.28	15.35	54.96	885.13
Western Australia	26.38	4.65	15.05	56.86	901.44

**Source:** Geoscience Australia

### 11.3.2 Ocean energy market

In Australia, four electricity generation units based on either tidal or wave energy have been developed in recent years (table 11.7). All four units are pilot or demonstration plants with capacities of less than 0.5 MW. These four projects have collectively added less than 1 MW of generating capacity, but they represent an important stage in the technology innovation process for ocean energy in Australia.

Carnegie Wave Energy Limited (formerly Carnegie Corporation) holds the intellectual property and global development rights for the Cylindrical Energy Transformation Oscillator (CETO) wave energy converter (see Box 11.2 for a technology description). Carnegie completed the CETO 2 pilot test (proof of concept) at Fremantle and in late 2009 announced plans for a demonstration project (box 11.3).

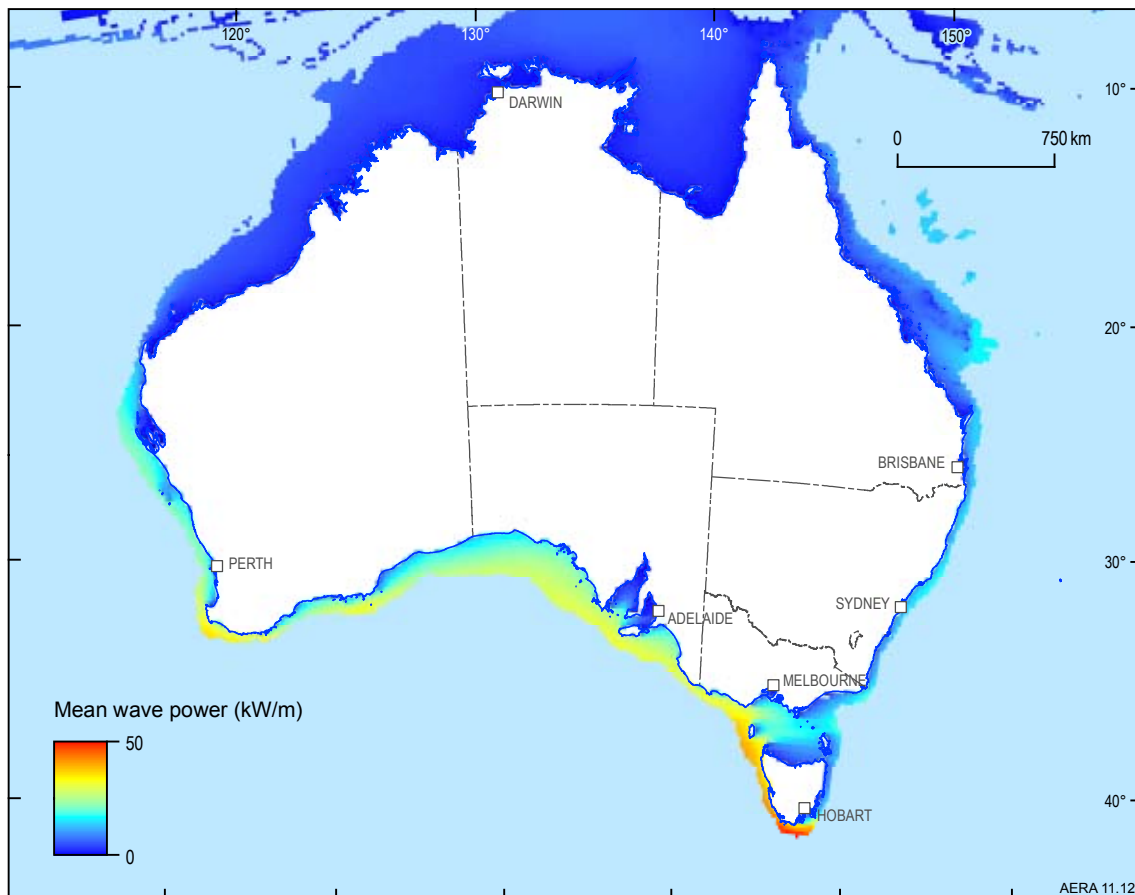
Oceanlinx has had a 500 kW prototype oscillating water column wave power unit (box 11.2) at Port Kembla, New South Wales since 2006. This unit is currently being replaced by a third generation demonstration scale device designed to suit the

environment at Port Kembla and is due to be commissioned in early 2010. Oceanlinx is also developing a large scale demonstration project (up to 2.5 MW per wave energy converter) at Portland, Victoria ([www.oceanlinx.com](http://www.oceanlinx.com)).

The most recent ocean energy project based on tidal energy began operations in 2008. The 150 kW tidal plant was installed by Atlantis Resources Corporation at Phillip Island (south of Melbourne) ([www.atlantisresourcescorporation.com](http://www.atlantisresourcescorporation.com)).

### 11.4 Outlook to 2030 for Australia's ocean energy resources and market

Ocean energy resources have significant potential for future utilisation but are at an early stage of development and have yet to be demonstrated to be a commercially viable option for electricity generation in Australia. However, given the level of global RD&D activity, it is possible that technological and economic advances will increase the commercial attractiveness of ocean energy.



**Figure 11.12** Spatial distribution of time-averaged wave power on the Australian continental shelf (kW/m). The wave power at each location represents a time-average of the available 11-year time series from March 1997 to February 2008

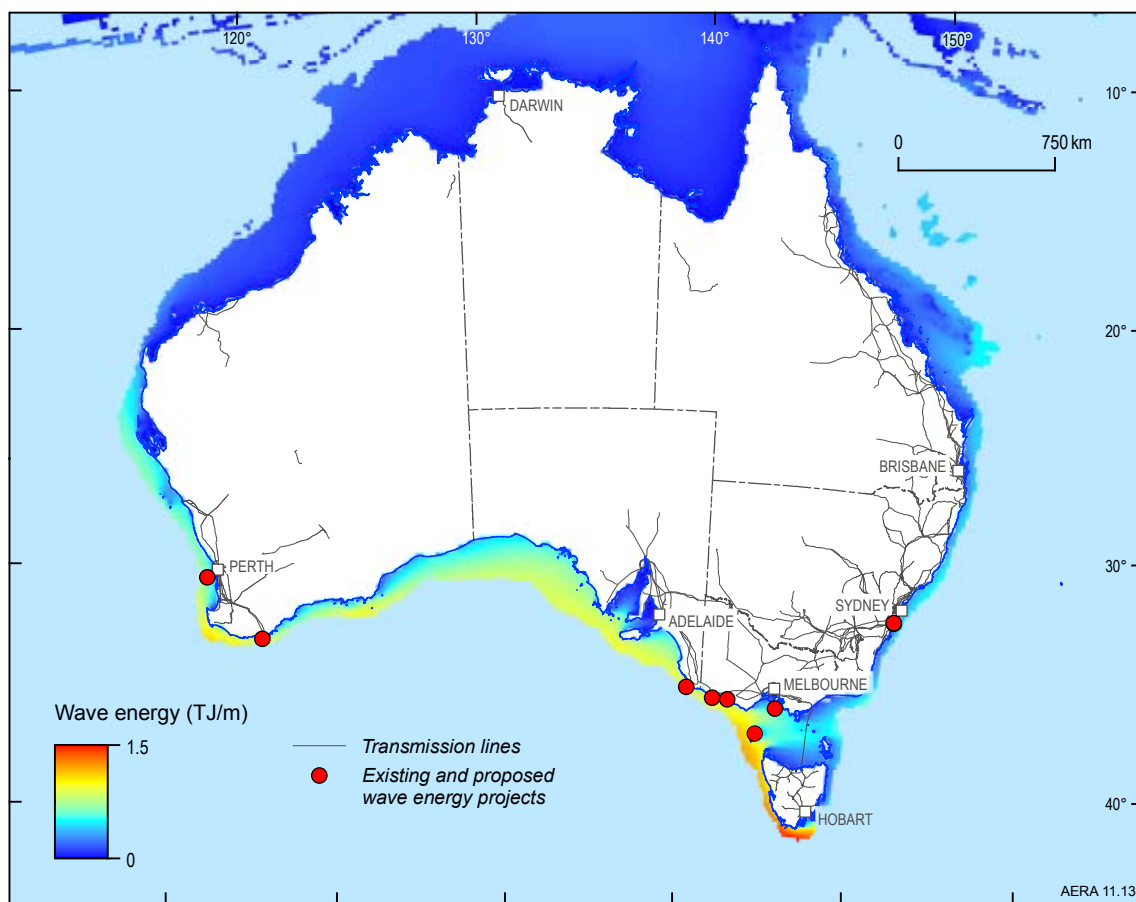
**Source:** Geoscience Australia

### 11.4.1 Key factors influencing the future development of Australia’s ocean resources

Australia has a significant potential ocean energy resource, especially along its western, northern and southern coastlines if both waves and tides are considered. Government policies such as the expanded Renewable Energy Target (RET) and the proposed emissions reduction target could contribute to a more favourable environment for ocean energy resource development. There has also been direct government funding for ocean energy: Victorian Wave Partners obtained a \$66 million grant from the Australian Government towards the cost of a 19 MW commercial-scale wave power demonstration

project at Portland. The grant was funded from the Renewable Energy Demonstration Program.

Despite its potential, there are significant constraints on the future development of ocean energy in Australia. Two limitations in particular need to be addressed: technologies for the commercial conversion and utilisation of ocean energy are still immature; and capital costs, including grid connection, are high relative to other energy sources. A number of technologies have passed proof-of-concept stage but many are yet to deliver electricity to a grid. Some of them have reached the commercial scale demonstration stage and may be in commercial operation by mid-this decade, but they will still be in



**Figure 11.13** Total annual wave energy (TJ/m) on the Australian continental shelf (water depths less than 300 m) and wave energy projects. The total annual wave energy at each location represents an average of the 11 years from March 1997 to February 2008

Source: Geoscience Australia

**Table 11.7** Ocean energy pilot and demonstration plants in Australia

Project	Company	State	Start up	Capacity
Portland (wave energy)	Ocean Power Technologies and Powercor Aust	VIC	2002	0.02 MW
Fremantle (wave energy)	Carnegie Wave Power Ltd	WA	2005	0.1 MW
Port Kembla (wave energy)	Oceanlinx	NSW	2006	0.5 MW
San Remo (tidal energy)	Atlantis Resource Corporation	VIC	2008	0.15 MW

Source: Geoscience Australia

competition with other – in some cases more mature and lower cost – renewable energy technologies.

### **Ocean energy provides a low emissions source of energy with potential for base load electricity generation**

Ocean energy is a relatively predictable, and therefore a potentially attractive source of electricity, generated with low greenhouse gas emissions. The reliability of some forms of ocean energy such as ocean thermal may make it potentially suitable for base load electricity generation. Other forms of ocean energy, such as tidal energy, while not consistent in providing energy, can be accurately predicted, and therefore, should facilitate grid integration:

- **Tidal energy** is very predictable, but cannot be used to generate electricity at consistent levels constantly. Twice in every 12.42 hours (24 hours in some locations) the tidal current speed and hence the electricity generation capability falls to zero. If tidal energy is required to produce a sustained base load for the local grid, some form of energy storage or back-up will be needed.
- **Waves** are rarely of consistent length or strength. Wave energy levels may vary considerably from wave to wave, from day to day, and from season to season, because of variations in local and distant wind conditions. This inherent variability needs to be converted to a smooth electrical output to be a reliable source of electricity supply. Moreover, there are sites on the western and southern coastlines where regular storms in the Southern Ocean generate consistent swells with periods of wave energy failure both of low frequency and short duration. Higher level forecasting, grid management or possibly energy storage systems are needed to smooth out such peaks and troughs in supply.
- **Ocean thermal energy** is potentially suitable for base load electricity generation, as the ocean temperatures on which it relies show only slight variation between seasons (WEC 2007).

### **RD&D activity is critical for the future development of ocean energy resources**

Despite the large potential ocean energy resource, the low level of market uptake can be largely attributed to the currently immature extraction technology and the large number of different technologies being trialled. Tidal current systems are converging on a few different converter designs; for other forms of ocean energy, there has so far been no such convergence:

- **Tidal energy technologies** – tidal energy extraction technology is essentially analogous to that of wind energy. Both require a passing current to drive a rotating turbine. Tidal

energy turbines are subject to less turbulent environments than wave energy.

- **Wave energy technologies** – Many different wave energy converters are at the prototype stage and are undergoing trials in a number of countries. This is partly explained by the need to develop technologies for a range of different wave energy environments and climatic conditions, including the ability to survive significant storms, and by the lack of individual technologies that have been shown to be commercially viable.
- **Ocean thermal energy technologies** – ocean thermal energy conversion technologies are relatively new and still need to be proven in pilot scale and demonstration scale plants. Land-based, floating and grazing plants are all options. OTEC is best suited to tropical waters with warm surface waters.

Currently, 25 countries are participating in the development of ocean power, with the United Kingdom leading the development effort, followed by the United States, Canada, Norway, Australia and Denmark. In Portugal three Pelamis wave energy converters with a combined capacity of 2.25 MW have been trialled, but are currently not in use.

Although there is potential energy from other ocean sources, current ocean power development efforts have focussed on tidal and wave energy (IEA 2009c).

### **Tidal energy**

At least nine countries outside Australia have a demonstrated interest in tidal energy for commercial electricity generation (table 11.8). All of these countries provide support for R&D in universities and/or government-funded research institutes; the R&D commitment extends to the commercial sector in eight of the countries. There are full-scale plants currently operating in three countries. In addition, in 2009 a 1 MW tidal plant was commissioned in the Republic of Korea and the 260 MW tidal plant utilising an existing sea wall at the entrance to Lake Sihwa is under construction. The project will create environmental flows for the lake. A major tidal development project has also been advanced for the Severn River in the United Kingdom, based on a series of three proposed barrages and two lagoons.

### **Wave energy**

A significant number (at least 20) of countries, including Australia, have demonstrated an interest in wave energy for commercial electricity generation (table 11.9). All but Spain are involved in R&D in universities and/or government-funded research institutes; the R&D commitment extends to the commercial sector in 14 of the countries.

Currently operating full-scale projects, albeit at the demonstration stage, exist in 10 countries outside Australia. The size of these current projects range from small plants of hundreds of kilowatts in size, to the largest being the 2.25 MW Aguçadoura Wave Park near Póvoa de Varzim in Portugal. This project, and its proposed expansion to 21 MW, have been suspended pending resolution of technical issues and obtaining new financing. A 4 MW wave farm is planned for Siadar on the Isle of Lewis in Scotland.

A more substantial project, the South-west Region Development Authority's Wave Hub in Cornwall, is well advanced in organisation of a 20 MW wave energy array, involving a number of technology suppliers each installing 4–5 MW systems. OPT, which as a member of Victorian Energy Partners, is developing a demonstration project at Portland with the Australian Government's assistance, is the first technology supplier engaged to install generators at the Cornwall Wave Hub.

### Ocean thermal energy

An important focus in RD&D activity, particularly in Europe, is the combination of OTEC technologies with other deep water applications, such as potable water production, that result in benefits in addition to electricity generation (WEC 2007). Three major studies in Europe (European Commission, Maritime Industries Forum and UK Foresight) have resulted in recommendations for both OTEC and other deep water energy applications that emphasised funding and construction of a plant in the 5–10 MW range.

A demonstration plant with a capacity of 1–1.2 MW planned for construction in Hawaii is awaiting government approval following completion of an environmental impact assessment. Plans for 10 and 25 MW ocean thermal energy projects are being considered (WEC 2008).

R&D on OTEC and other ocean energy technologies has been undertaken since 1974 by a number of organisations in Japan. Saga University conducted the first OTEC electricity generation experiments in late 1979 and more recently has been collaborating with the National Institute of Ocean Technology of India on a 1 MW plant off the Indian coast (WEC 2008).

### Ocean energy technologies are expected to be relatively high cost options until technologies mature

Given the largely pre-commercial status of the current ocean energy industries, the outlook is highly dependent on the amount of resources devoted to RD&D, and the potential for cost reduction over time. This includes RD&D activity both in surveying techniques to assess energy potential and energy conversion technologies.

**Table 11.8** Country involvement in tidal energy R&D and/or with full scale plant

Country	Govt and Academic R&D	Commercial R&D	Currently Operating Projects
Canada	✓	✓	✓
China	✓	✓	✓
France	✓	✓	✓
India	✓		
Republic of Korea	✓	✓	Under construction
Norway	✓	✓	
Russian Federation	✓	✓	
United Kingdom	✓	✓	
United States of America	✓	✓	

**Note:** Table may not include all projects, especially smaller R&D projects, but includes the main countries involved

**Source:** IEA 2009c

**Table 11.9** Country involvement (other than Australia) in wave energy R&D and/or with full-scale projects

Country	Govt and Academic R&D	Commercial R&D	Currently Operating Projects
Canada	✓	✓	
China	✓	✓	✓
Denmark	✓	✓	✓
Finland	✓	✓	
France	✓		
Germany	✓		
Greece	✓	✓	
India	✓	✓	
Ireland	✓	✓	✓
Japan	✓	✓	✓
Mexico	✓		
Netherlands	✓	✓	
New Zealand	✓	✓	✓
Norway	✓	✓	✓
Portugal	✓	✓	✓
Spain			✓
Sri Lanka	✓		
Sweden	✓		
United Kingdom	✓	✓	✓
United States of America	✓	✓	✓

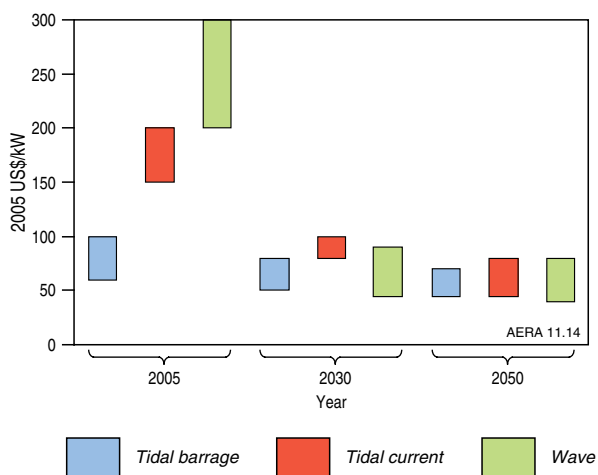
**Source:** IEA 2009c



Investment costs are currently lower for tidal barrage systems than for tidal current or wave systems. Investment costs for tidal barrage systems are estimated to have been US\$2–4 million per MW in 2005, while investment costs for tidal current and wave systems are estimated to have been US\$7–10 million per MW and US\$6–15 million per MW, respectively (IEA 2008). Shoreline installations and tidal barrage systems typically have a lower production cost than deep water devices, but most deep water technologies are still at the R&D stage. However, wave energy technologies tend to have higher costs because of unscheduled maintenance caused by storm damage.

Ocean energy technologies are expected to remain relatively high cost options for development in the medium term.

Investment and production costs for ocean energy systems are projected to fall over time. They are projected to fall more significantly for wave energy systems than for tidal barrage systems as wave technologies are currently less mature. Tidal barrage systems currently have the lowest production cost of all ocean energy technologies. Tidal barrage production costs were estimated to have ranged from US\$60 to US\$100 per kW in 2005, while the production cost of tidal current systems is estimated to have been US\$150–200 and the production cost of wave energy systems to have been US\$200–300 (IEA 2008). As the relatively newer wave and tidal current technologies mature, the difference between the production costs of these technologies and tidal barrage systems is projected to fall. By 2030, the production costs of ocean energy technologies are projected to range from US\$45 to US\$100 per kW (in 2005 dollars) (figure 11.14).



**Figure 11.14** Ocean energy production costs  
**Source:** IEA 2008

## Australia's population is mainly located in coastal areas, but grid access may be a significant issue for more remote future ocean energy projects

### Tidal energy

The best tidal energy resources tend to be located off the more remote coastlines along the northern margin of Australia. With the present technology constraints, the most suitable sites for harvesting with good access to the electricity grid favour only a few regional centres, although there are large resources within reasonable proximity to the major centres of Darwin and Mackay. The domestic demand for electricity is relatively small in the very well-resourced areas of the Kimberley and Pilbara, but tide-generated electricity could potentially contribute to the energy requirements of the mining sector.

The environmental impact of a barrage-type power station may not be acceptable in these environmentally sensitive regions. However, there is the potential for converters that harvest kinetic energy from tidal currents with much lower environmental impact. The 1.2 MW tide turbine being installed at Koolan Island (Western Australia) will meet up to 20 per cent of the power needs of the mining operations there when operational in 2010 (box 11.3). In general, however, the industrial loads of remote mining operations are commonly serviced by gas-fired generators. New renewable energy options such as tidal or wave, in the absence of capital grants or other subsidies such as feed-in tariffs, will need to compete with the prevailing, long-run, marginal cost of gas generation.

### Wave energy

The best wave energy resources tend to be located off the more remote coastlines along the southern margin of Australia. With the current technology constraints, the most suitable sites for harvesting with access to the electricity grid favour only a few regional centres. This may change in time if the current small-scale projects of 0.5 MW to 1 MW evolve into significant projects of 100 MW or more, and the possibility of connecting over longer distances to the grid – or expanding the grid – to take advantage of this resource is demonstrated to be economic.

## Ocean energy is a zero or low emissions renewable resource, but other environmental impacts also need to be assessed

Electricity generation from wave or tidal energy produces no greenhouse gas emissions; however, emissions associated with the production of the wave or tide energy device and other environmental issues must also be taken into account.

Tidal barrages disrupt the surrounding environment more than other tidal or wave energy systems. Tidal barrages reduce the range of tides that occur inside the barrage. This may have negative impacts on water quality and biodiversity in the surrounding area and cause loss of habitat where intertidal zones are reduced in area (IEA 2008). Offshore tidal or wave energy projects typically have a lower impact on the environment. However, offshore systems may pose a navigation hazard, and therefore must be located in areas that are not heavily navigated. There may also be potential conflicts with other local uses of the marine area and a possible impact on migrating marine mammals. The extent of the potential impacts will depend on the type of wave energy converter technology; undersea technologies tend to have less impacts.

Wave and tidal energy systems located near the shoreline may be objected to by nearby communities on the grounds of noise and possibly visual pollution. This may result in public opposition to projects, particularly if they are located in populated areas.

#### 11.4.2 Outlook for ocean energy resources

Wave and tidal energy are non-depletable resources; increased use of the resources does not affect resource availability. However, estimates of resource availability may change over time as new measurement methods become available. In addition, the quantity of the resource that can be utilised will change over time as new technology developments allow increased exploitation of ocean resources.

The tidal energy resource assessment presented in Section 11.3.1 suggests that there is future development potential, largely on the northern half of Australia's continental shelf and particularly

in King Sound and the Bonaparte Gulf (Western Australia), Darwin (Northern Territory), the Torres Strait and southern parts of the Great Barrier Reef (Queensland). The quality of the resource is spatially variable, but also highly predictable once field measurements of one year's duration have been obtained for a site. The suitability of sites will also be influenced by water depth and seabed type, which affect the engineering of tide energy converters and placement of cables across the seabed.

The wave energy resource assessment discussed in Section 11.3.1 suggests that there is future development potential across the southern half of Australia's continental shelf from Exmouth around to Brisbane. The quality of the resource is variable, with the failure rate of the waves to deliver sufficient energy and the frequency of failures generally increasing in the more northerly waters. There may also be strong local variability in both the resource and its accessibility; the latter being determined by requirements for particular water depths and seabed types for installation of the wave energy converters and networks of pipe or cable across the seabed.

#### 11.4.3 Outlook for ocean energy market

The major ocean energy developments occurring in Australia are focussed on proving up technologies for tidal or wave energy. Several companies have plans for pilot and demonstration plants (box 11.3). Importantly for the future of the ocean energy industry, companies are now investing in commercial scale power projects. This is an essential step in demonstrating the technical and economic viability of these technologies. Early demonstration of the commercial viability of these or comparable technologies could well accelerate the development of wave and tide energy in Australia.

### BOX 11.2 CURRENT OCEAN ENERGY TECHNOLOGIES

#### *Tidal energy technologies*

The rotating tide waves result in different sea levels from one place on the shelf to the next at any one time, and this causes the water column to flow horizontally back and forth (tidal currents) over the shelf with the tidal oscillations in sea level. Two different technologies have been developed to harness these tidal movements.

The design of underwater turbines has advanced considerably in recent years, but there is still considerable research and development seeking to maximise efficiency and robustness while minimising overall size (figure 11.15).

Barrages harness some of the potential energy of the tide. In essence, a barrage with sluice gates allows water to enter the basin on the rising tide, and at

high tide the sluice gates are closed, thus trapping a large body of water (figure 11.15). As the water level on the ocean side of the barrage falls with the ebbing tide, the elevated water from behind the barrage is released through the sluice gates, where turbines are located, to generate electricity. The principle is similar to hydro-electric schemes on dammed rivers. More complicated systems of basins and barrages can be designed to generate electricity on both the ebbing and flooding tide. The potential energy that is available to be harnessed is related to the vertical tide range and the horizontal area of the basin (the tidal prism).

Tidal stream generators focus on the kinetic energy component of the tide. A turbine is placed within a tidal current and the kinetic energy

associated with the horizontal motion of the water drives the turbine to generate electricity. There are turbines developed for relatively shallow water installation that rotate in a vertical plane, and others that rotate in a horizontal plane.

The first (and still the largest) tidal power station was built on the Rance River estuary in France, between 1961 and 1966. It has been operating continuously since then. It is a barrage-type system consisting of an 800-metre long dam enclosing a basin with a surface area of 22.5 km<sup>2</sup>. The spring tide range is up to 13 m. The plant has a power generating capacity of 240 MW and it delivers 2.3 PJ of energy annually to the grid (World Energy Council 2007). A smaller barrage-type station at Annapolis, on the Bay of Fundy, Canada was completed in 1984. The tide range in this location can exceed 12 m (Pugh 2004). This plant has a power capacity of 20 MW and delivers 108 TJ annually. The Republic of Korea is currently building the largest barrage-type power station (260 MW) at Sihwa Lake with completion due this year. China has seven small barrage-type power stations with a total capacity of 11 MW, and plans for more. India also has plans for a barrage-type power station (World Energy Council 2007).

Power stations seeking to harness the kinetic energy of tidal currents are presently much smaller, and still in the developmental phase. Norway has the first grid connected underwater turbine located at Kvalsundet, which has a 300 kW power capacity (World Energy Council 2007). There are similar pilot projects in the Russian Federation, the United Kingdom and the United States.

#### Wave energy technologies

To operate efficiently a wave energy converter must be tuned for the modal wave energy conditions, but also designed and engineered to withstand extreme energy conditions. This poses a significant challenge,

because it is the lower energy levels that produce the normal output, but the capital cost is driven by the design standard necessary to withstand extreme waves (WEC 2007). There is a large number of designs for wave energy converters. For the most part, they can be broadly grouped into one of four types (table 11.10).

**Oscillating water columns** (OWCs) consist of a semi-enclosed air chamber that is partially submerged (figure 11.16). The passage of waves past the chamber causes the water level inside the chamber to rise and fall, and the oscillating air pressure drives air through a turbine to generate electricity. OWCs have been developed for installation on the shoreline, in shallow water resting on the seabed, and in deep water mounted on a surface buoy.

**Hinged (and similar) devices** are submerged units that consist of a paddle or buoy that oscillates with the passage of waves (figure 11.16). Both the Oyster and CETO use this motion to pump high pressure water ashore. The intention is for this water to be pushed through turbines located onshore for electricity generation. The water can also undergo reverse osmosis to produce potable water. These examples have passed proof of concept, delivering high pressure seawater ashore. However, these are yet to deliver electricity to the grid.

**Overtopping devices** are designed to cause ocean waves to push water up to a reservoir situated above sea level, from which the water drains back to sea level through several turbines (figure 11.16). These devices have been designed for both shoreline and offshore installation.

Of the remaining types, **the Pelamis wave energy converter** consists of two or more cylindrical sections linked together (figure 11.16). The passage of waves causes the sections to undulate, and the movement at the hinged joints is resisted by hydraulic cylinders

**Table 11.10** Examples of different types of wave energy converters

Device	Example	Location of installation	Location of generator	Proof of concept	Electricity to grid
Oscillating water columns	LIMPET	Shoreline	Onshore	✓	✓
	Energetech OWC	Seabed, shallow water	Offshore	✓	✓
	OPT PowerBuoy	Seabed, shallow water	Offshore	✓	
Hinged (and similar) devices	Oyster	Seabed, shallow water	Onshore	✓	✓
	CETO	Seabed, shallow water	Onshore	✓	
Overtopping devices	Wave Dragon	Surface, tethered to seabed	Offshore	✓	✓
	Seawave slot cone	Shoreline or offshore	Onshore or offshore	✓	
Other	Pelamis	Surface, tethered to seabed	Offshore	✓	✓
	Archimedes swing	Immediate	Offshore	✓	

that pump high pressure fluid through hydraulic motors and electrical generators. The **Archimedes Waveswing** consists of a sub-surface vertical cylinder tethered to the seabed (figure 11.16). An air-filled upper cylinder moves against a lower fixed cylinder with the passage of each wave. The vertical oscillatory motion is converted to electricity with a linear generator.

#### *Ocean thermal energy conversion (OTEC) technologies*

There are three types of electricity conversion systems for ocean thermal energy: closed cycle systems, open cycle systems and hybrid systems.

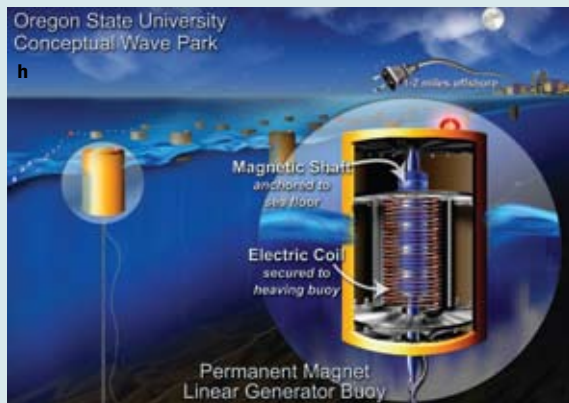
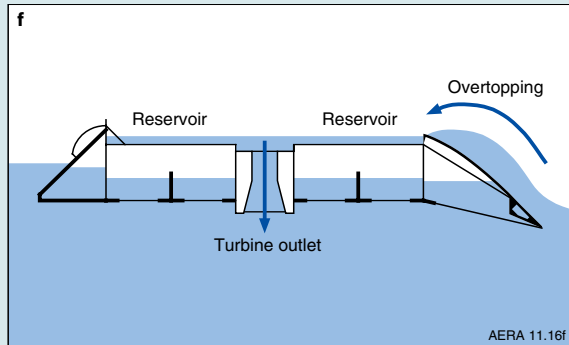
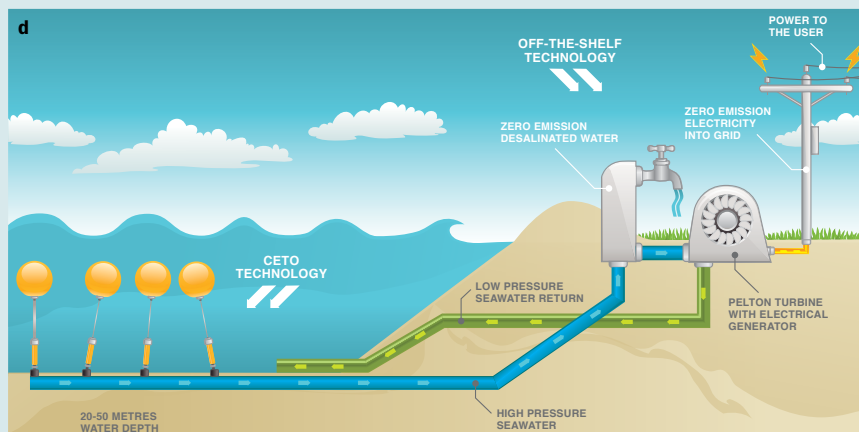
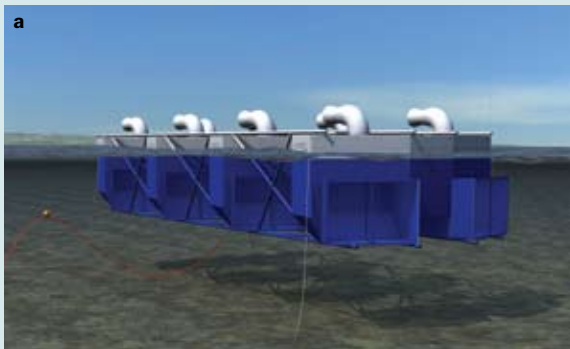
- **Closed-cycle systems** use the ocean's warm surface water to vaporise a working fluid with a low boiling point, such as ammonia. This vapour expands and turns a turbine which activates a generator to produce electricity.
- **Open-cycle systems** boil the seawater by operating at low pressures, producing steam that passes through a turbine to generate electricity.
- **Hybrid systems** combine both closed-cycle and open-cycle systems.



**Figure 11.15** Examples of different types of tidal energy converters. (a) La Rance River estuary tidal barrage (b) Schematic showing the water levels either side of a barrage during power generation (c) Sea Generation Ltd's SeaGen turbine with blades elevated for servicing (d) BioPower System's bioStream turbine (e) and (f) Atlantis Resources Corporation's Nereus and Solon turbines, respectively

**Source:** Wikimedia Commons; [www.seageneration.co.uk](http://www.seageneration.co.uk); [www.biopowersystems.com](http://www.biopowersystems.com); Atlantis Resources Corporation





**Figure 11.16** Examples of different types of wave energy converters. (a) Schematic of Oceanlinx MK3PC (oscillating water column) planned for installation at Port Kembla (b) Ocean Power Technologies' PowerBuoy®, Atlantic City, New Jersey (c) CETO wave energy converter (d) Schematic of CETO wave farm (e) Wave Dragon overtopping device (f) Schematic showing the operation of Wave Dragon (g) Pelamis wave energy converter (h) Schematic of Archimedes wave swing

**Source:** [www.oceanlinx.com](http://www.oceanlinx.com); [www.oceanpowertechnologies.com](http://www.oceanpowertechnologies.com); [www.carnegiecorp.com.au](http://www.carnegiecorp.com.au); [www.wavedragon.co.uk](http://www.wavedragon.co.uk); [www.pelamiswave.com](http://www.pelamiswave.com); Oregon State University



OTEC plants may be land-based, floating or grazing (WEC 2007):

- **Land-based plants** have the advantage of no transmission cable to shore and no mooring costs, but require a cold water pipe to cross the surf zone and follow the seabed to the required depth. This results in lower efficiency because a longer pipe has greater friction losses and there is greater warming of the cold water before it reaches the heat exchanger.
- **Floating plants** require a transmission cable to shore and moorings in deep water, but have the advantage that the cold water pipe is shorter. Technology developments in high voltage DC transmission and mooring in the offshore oil and gas industry may be utilised in floating plants.
- **Grazing plants** are able to drift in ocean areas that are prospective for ocean thermal energy where the output, liquid hydrogen, would be offloaded into shuttle tankers for transport to market.

### BOX 11.3 PROPOSED OCEAN ENERGY DEVELOPMENT PROJECTS IN AUSTRALIA

Australia currently has no commercial scale ocean energy projects at an advanced stage of development.

There are four commercial scale projects that are at a less advanced stage of development, three of which are based on utilising tidal energy (table 11.11). These projects are significantly larger than those previously commissioned in Australia, with a combined capacity of 805 MW. Two projects account for around 93 per cent of this additional capacity – the Clarence Strait Tidal Energy project (450 MW) in the Northern Territory and the Banks Strait Tidal Energy project (302 MW) in Tasmania. Both projects have been proposed by Tenax Energy and are expected to enter production in 2011 and 2013 respectively.

There are at present no barrage-type tidal power stations in Australia. Several proposals have been put forward for a station at Derby, Western Australia, including a 2001 proposal for a 5 MW plant to deliver 68.4 TJ per year (Hydro Tasmania 2001). It has been set aside because of the environmental impacts of a construction of this scale on sensitive wetlands and high grid connection costs.

Atlantis Resources Corporation currently operates a 150 kW (soon to be upgraded to 400 kW) Nereus turbine at a test site at San Remo, Victoria, that is connected to the electricity grid. The company is installing a 1.2 MW tidal plant near Cockatoo and Koolan Islands in King Sound, north of Derby in Western Australia that is expected to be operational in early 2010. The project involves the installation of a 16.5 metre Nereus turbine that will provide up to 20 per cent of the power needs of Mt Gibson Iron ([www.atlantisresourcescorporation.com](http://www.atlantisresourcescorporation.com)).

BioPower Systems has a proposal for a small pilot plant (250 kW) at Flinders Island, Tasmania,

to commence this year. The project involves the installation of a 20 metre bioSTREAM turbine.

There are several commercial scale wave energy demonstration projects either proposed or under way, in Western Australia, South Australia, Victoria and Tasmania. Carnegie Wave Energy Limited announced that it had completed a feasibility assessment that identified Garden Island as the preferred site for the development of a 5 MW demonstration wave energy project based on CETO 3 wave converter. The company has five other project sites in Australia at the licensing agreement stage spread across Western Australia, South Australia and Victoria (Albany, Port MacDonnell, Portland, Warnambool and Phillip Island) and is undertaking a feasibility study to assess the viability of using wave energy to supply power to the remote naval base at Exmouth in WA ([www.carnegiecorp.com.au](http://www.carnegiecorp.com.au)).

Victorian Wave Partners, a partnership between Ocean Power Technologies Australasia (OPTA) and Leighton Contractors Pty Ltd, have been awarded a grant under the Australian Government's Renewable Energy Demonstration Program (REDP) to develop a 19 MW wave power demonstration project near Portland in Victoria, Australia. The project will use Ocean Power Technologies Inc's PowerBuoy® wave energy converter (box 11.2; [www.oceanpowertechologies.com](http://www.oceanpowertechologies.com)).

BioPower Systems has a 250 kW pilot project planned for King Island, Tasmania, in collaboration with Hydro Tasmania using its BioWAVE seabed-mounted hinged wave energy converter. The pilot is scheduled to be operational in 2010, with the intention of connecting it to the island's electricity grid.

Oceanlinx is planning demonstration project trials of its wave energy converter technology in Portland, Victoria. The project will involve the installation

of multiple units integrated into a single wave farm ([www.oceanlinx.com](http://www.oceanlinx.com)). The Victorian Government is an investment partner in this project, through its Centre for Energy and Greenhouse Technologies. Subject

to the successful completion of the demonstration phase, the company is considering installation of a wave energy conversion array with a total capacity of 30 MW.

**Table 11.11** Commercial scale tidal energy projects at a less advanced stage of development in Australia

Project	Company	Location	Status	Start up	Capacity	Capital Expenditure
Victorian Wave Power Demonstration Project	Victorian Wave Partners Pty Ltd	Portland, Vic	Govt grant awarded	na	19 MW	na
Clarence Strait Tidal Energy Project	Tenax Energy Pty Ltd	Clarence Strait, NT	Govt approval under way	2011	450 MW	na
Port Phillip Heads Tidal Energy Project	Tenax Energy Pty Ltd	Port Phillip Heads, Vic	Govt approval under way	2012	34 MW	na
Banks Strait Tidal Energy Facility	Tenax Energy Pty Ltd	Banks Strait, TAS	Govt approval under way	2013	302 MW	na

Source: ABARE 2009

## 11.5 References

ABARE (Australian Bureau of Agricultural and Resource Economics), 2009, Electricity Generation Major Development Projects – October 2009 Listing, Canberra, November 2009

Australian Hydrographic Service, 2006, Australian National Tide Tables, Royal Australian Navy, Canberra

Carnegie Corporation, 2008, Carnegie 2007 Annual Report, Carnegie Corporation Ltd

Hasselmann K and the WAMDI Group, 1988, The WAM Model – A third generation ocean wave prediction model. *Journal of Physical Oceanography*, 18, 1775–1810

Hydro Tasmania, 2001, Study of Tidal Energy Technologies for Derby. Hydro Electric Corporation, Report No. WA-107384-CR-01

Hughes MG and Heap AD, 2010, National-scale wave energy resource assessment for Australia. *Renewable Energy* (in press)

IEA (International Energy Agency), 2008, Energy Technology Perspectives 2008 – Scenarios & Strategies to 2050, Paris

IEA, 2009a, World Energy Balances (2009 edition), Paris

IEA, 2009b, World Energy Outlook 2009, Paris

IEA, 2009c, Ocean Energy: Global technology development status, Paris

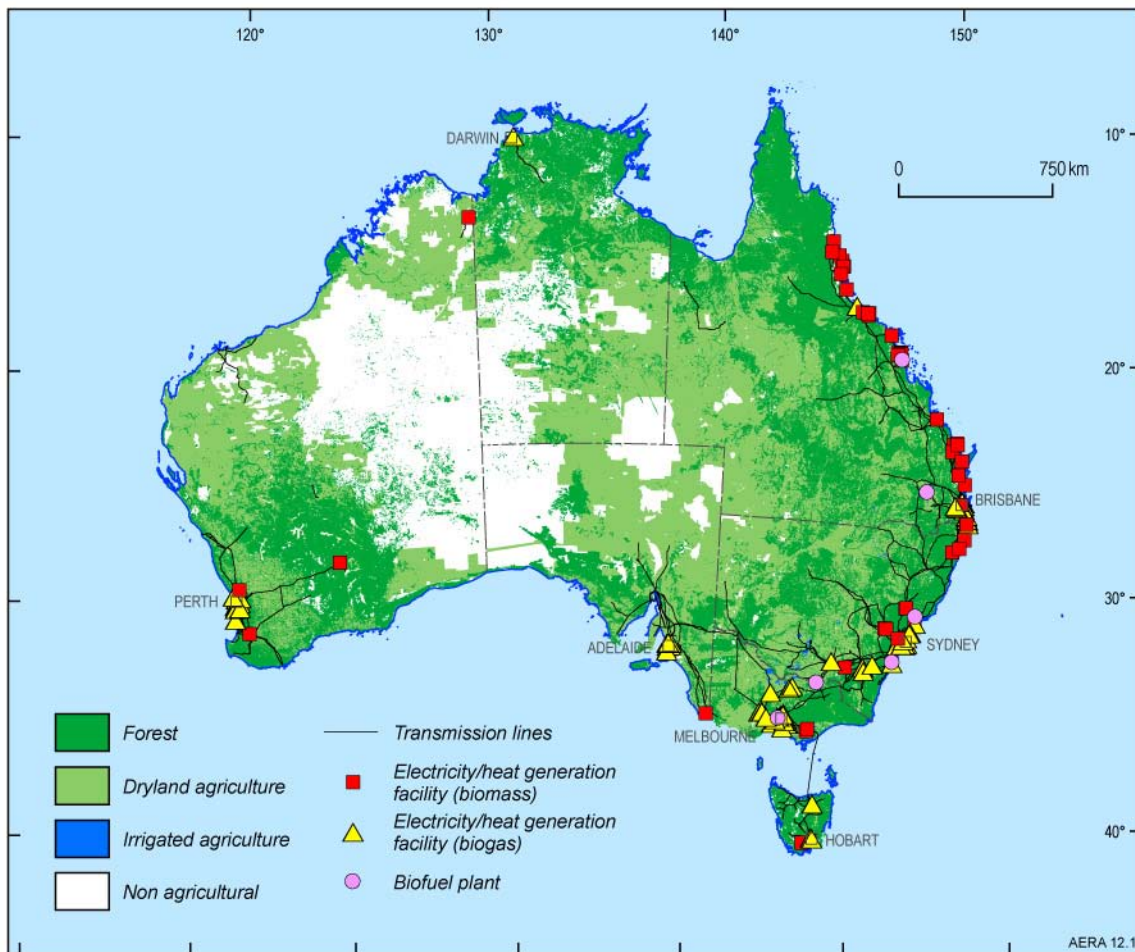
Porter-Smith R, Harris PT, Andersen OB, Coleman R, Greenslade D and Jenkins CJ, 2004, Classification of the Australian continental shelf based on predicted sediment threshold exceedence from tidal currents and swell waves. *Marine Geology*, 211, 1–20

Pugh D, 2004, *Changing Sea Levels: Effects of Tides, Weather and Climate*, Cambridge University Press

WEC (World Energy Council), 2007, Survey of Energy Resources 2007, London, <[http://www.worldenergy.org/documents/ser2007\\_final\\_online\\_version\\_1.pdf](http://www.worldenergy.org/documents/ser2007_final_online_version_1.pdf)>

WEC (World Energy Council), 2008, Survey of Energy Resources, Interim Update 2009, <[http://www.worldenergy.org/publications/survey\\_of\\_energy\\_resources\\_interim\\_update\\_2009/default.asp](http://www.worldenergy.org/publications/survey_of_energy_resources_interim_update_2009/default.asp)>





**Figure 12.1** Land use and bioenergy facilities in Australia

**Note:** Areas depicted as under irrigation are exaggerated for presentation

**Source:** Geoscience Australia and Bureau of Rural Sciences

#### 12.1.4 Australia's bioenergy market

- Bioenergy accounted for only 4 per cent of Australia's primary energy consumption in 2007–08, but it represented 78 per cent of Australia's renewable energy use.
- The majority of Australia's bioenergy use is sourced from bagasse and wood waste, which represents 92 per cent of bioenergy use for direct heat and electricity generation. Biogas represents 6 per cent of bioenergy use and the remaining 2 per cent is biofuels for transport fuel.
- ABARE's latest Australian energy projects include the Renewable Energy Target (RET), a 5 per cent emissions reduction target and other government policies. Bioenergy use in Australia is projected to increase by 2.2 per cent per year to 340 petajoules (PJ) in 2029–30 (figure 12.2).
- Electricity generation from bioenergy is projected to increase from 2 terawatt hours (TWh) in 2007–08 to 3 TWh by 2029–30 growing at an average rate of 2.3 per cent per year (figure 12.3).

## 12.2 Background information and world market

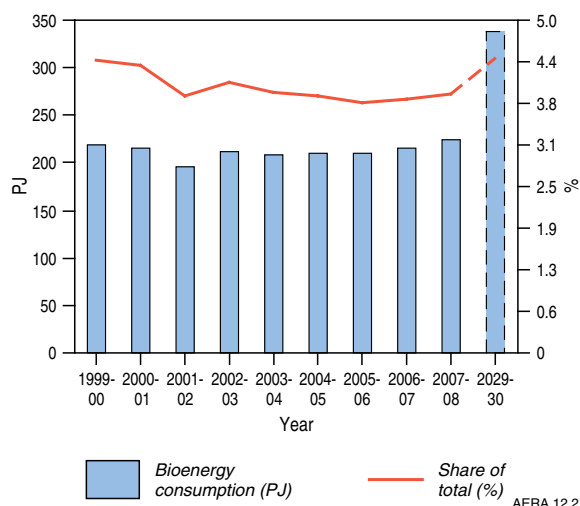
### 12.2.1 Definitions

**Bioenergy** denotes the use of organic material (biomass) as a source of energy for power generation and direct source heat applications in all energy sectors including domestic, commercial and industrial purposes as well as the production of liquid fuels for transport.

Bioenergy is a form of renewable energy. Biomass releases carbon dioxide (CO<sub>2</sub>) and small amounts of other greenhouse gases when it is converted into another form of energy. However CO<sub>2</sub> is absorbed during the regrowth of the restored vegetation through photosynthesis process.

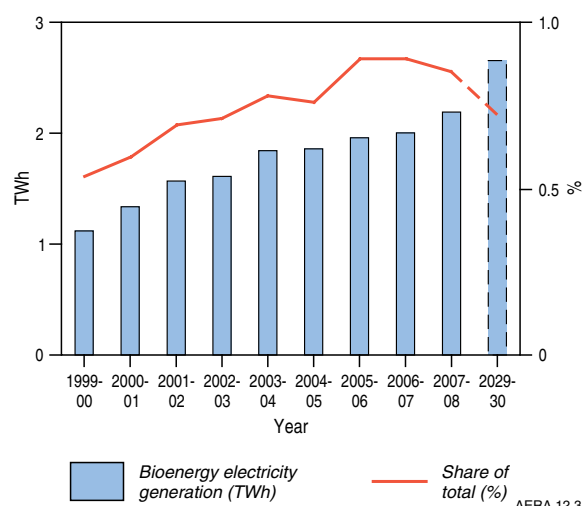
**Biomass** is vegetable and animal derived organic materials, which are grown, collected or harvested for energy. Examples include wood waste, bagasse and animal fats.

A conventional combustion process converts solid biomass through direct burning to release energy in the form of heat which can be used to generate



**Figure 12.2** Projected primary consumption of bioenergy in Australia

Source: ABARE 2009a; ABARE 2010



**Figure 12.3** Projected electricity generation from bioenergy in Australia

Source: ABARE 2009a; ABARE 2010

electricity and heat. Chemical conversion processes breaks down the biomass into fuels, in the form of biogas or liquid biofuels, which are then used for electricity generation and transport.

**Biogas** is composed principally of methane and CO<sub>2</sub> produced by anaerobic digestion of biomass. It is currently captured from landfill sites, sewage treatment plants, livestock feedlots and agricultural wastes.

**Biofuels** are liquid fuels, produced by chemical conversion processes that result in the production of ethanol and biodiesel. Biofuels can be broadly grouped according to the conversion processes:

- **First generation biofuels** are based on fermentation and distillation of ethanol from sugar and starch crops or chemical conversion of vegetable oils and animal fats to produce biodiesel. First generation technologies are proven and are currently used at a commercial scale.
- **Second generation biofuels** use biochemical or thermochemical processes to convert lignocellulosic material (non-edible fibrous or woody portions of plants) and algae to biofuels. Second generation technologies and biomass feedstocks are in the research, development and demonstration (RD&D) stage.
- **Third generation biofuels** are in research and development (R&D) and comprise integrated biorefineries for producing biofuels, electricity generation and bioproducts (such as petrochemical replacements).

### 12.2.2 Bioenergy supply chain

Figure 12.4 provides a conceptual representation of Australia's current bioenergy industry. Currently, there is a wide range of bioenergy resources potentially available for bioenergy utilisation. Biomass used to

generate electricity and heat include agricultural and forest residues, and municipal wastes and residues. Biofuels are produced from waste products, grain (sorghum) and oil-bearing crops. Australian bioenergy production is mainly consumed domestically.

There is a range of technologies currently available for converting biomass into energy for electricity and heat generation and/or transport biofuels. The technologies are based on either thermal or chemical conversion processes or a combination.

The fuel type (in particular the heating value and moisture) and the conversion technology have an effect on energy conversion efficiency. The energy conversion efficiency for wood waste in a direct combustion facility is about 35 per cent, compared to between 70 and 85 per cent efficiency in a combined heat and power facility.

#### Electricity and heat generation

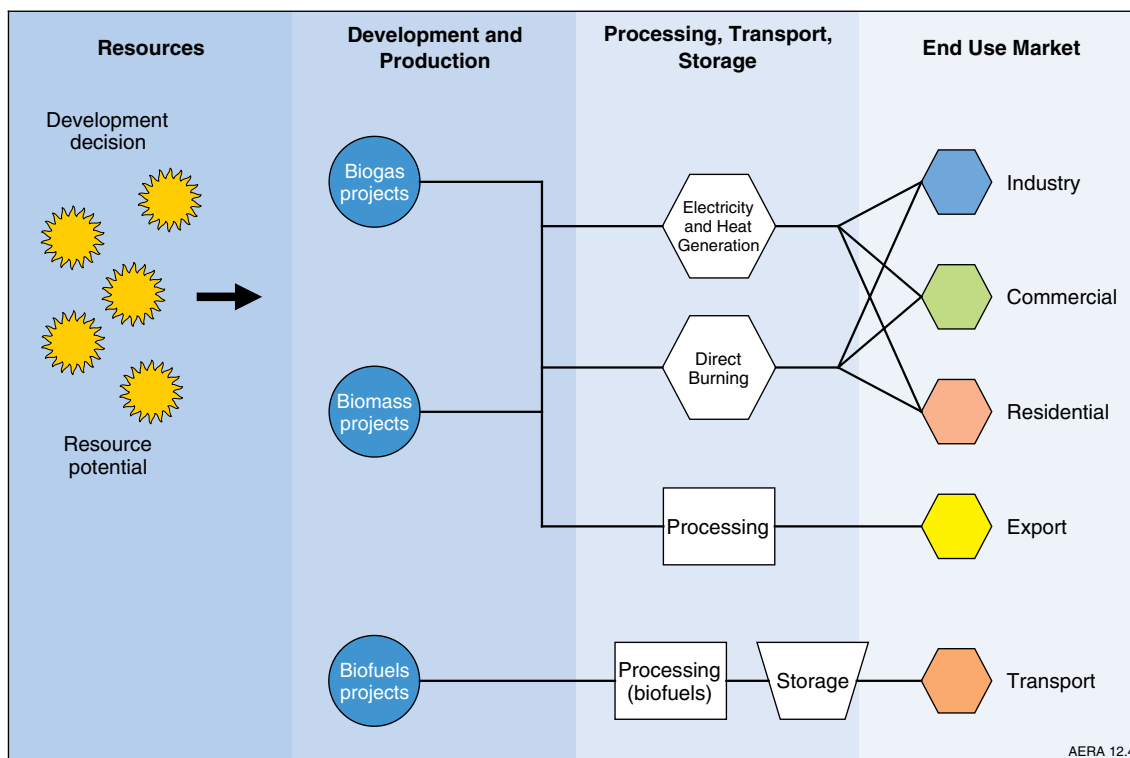
In Australia, biomass electricity generation is predominantly from bagasse (sugar cane residues) by steam turbine, with some cogeneration installation. Several wood waste bioenergy facilities use steam turbines and fluidised bed combustion technologies. There is minor electricity generation from co-firing with coal, and facilities using urban waste.

Biogas from landfill and sewage facilities are located in urban centres and generate electricity by means of reciprocating engine or gas turbine. Some facilities have cogeneration installations.

#### Transport biofuels

A small amount of biofuels is used in the transport sector. In Australia, first generation biofuels consist of ethanol produced from C-molasses and wheat starch by-products and grain (mainly sorghum), and biodiesel predominantly produced from tallow (animal fats) and used cooking oil.





**Figure 12.4** Australia's bioenergy supply chain

Source: ABARE and Geoscience Australia

**Table 12.1** Key bioenergy statistics

	unit	Australia 2007-08	OECD 2008	World 2007
<b>Primary energy consumption</b>	PJ	226	9317	48 980
Share of total	%	3.9	4.1	9.7
Average annual growth, since 2000	%	0.3	3.0	1.9
<b>Electricity generation</b>				
Electricity output	TWh	2.2	214	255
Share of total	%	0.9	2.0	1.3
Average annual growth, since 2000	%	8.7	4.8	6.0
Electricity capacity	GW	0.87	1.6	na
<b>Transport</b>	PJ	4.9	987	1207
Share of total	%	0.4	1.9	1.3
Average annual growth, since 2000	%	-	29.9	22.9

Source: IEA 2009a; ABARE 2009a

### 12.2.3 World bioenergy market

Around 10 per cent of the world's primary energy consumption comes from bioenergy (table 12.1). The share of bioenergy in primary energy consumption is higher in non-OECD countries than in OECD countries. In Australia, the bioenergy share is comparable to the OECD average, at around 4 per cent. The majority of the world's bioenergy is used directly for heat production through the burning of solid biomass; only 4 per cent is used for electricity generation and another 2.5 per cent is in the form of biofuels used in the transport sector.

### Resources

Global bioenergy resources are difficult to quantify due to the resources being committed to food, animal feed and material for construction. The availability of biomass for energy is also influenced by population growth, diet, agricultural intensity, environmental impacts, climate change, water and land availability (IEA Bioenergy 2008).

Current bioenergy resources consist of residues from forestry and agriculture, various organic waste streams and dedicated biomass production from pasture land, wood plantations and sugar cane.

Unused residues and waste are a significant under-exploited resource.

At present, the main biomass feedstocks for electricity and heat generation are forestry and agricultural residues and municipal waste in cogeneration and co-firing power plants. In 2007, fuel wood dominates (67 per cent) the share of biomass sources in the bioenergy mix (figure 12.5). Fuel wood is used in residential applications in inefficient stoves for domestic heating and cooking, which is also considered a major health issue in developing countries (IEA Bioenergy 2009a). This traditional use is expected to grow with increasing population, however there is scope to improve efficiency and environmental performance.

The main growth markets for power generation from bioenergy are the European Union, North America, Central and Eastern Europe and Southeast Asia (IEA Bioenergy 2007). China continues to increase power generation from industry-scale biogas (mainly livestock farms) and straw from agricultural residues. The sugar industry in many developing countries continues to build bagasse-fuelled power plants (REN21 2009).

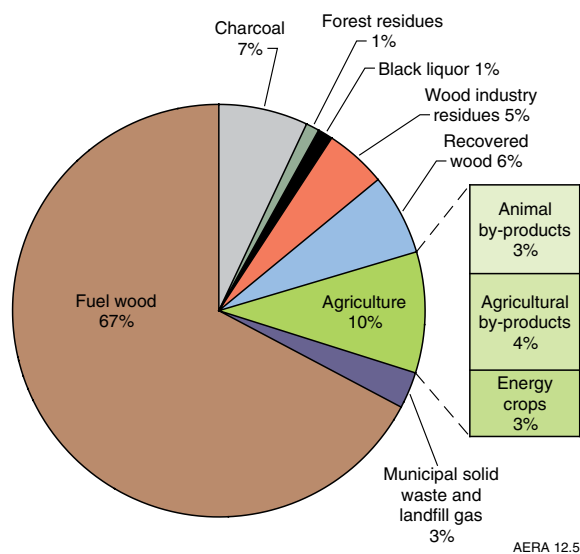
A small share of sugar, grain and vegetable oil crops is used for the production of biofuels. There is increasing interest in transport biofuels in Europe, Brazil, North America, Japan, China and India (IEA Bioenergy 2007). There is potential to expand the use of conventional crops for energy; however careful consideration of land availability and food demand is required.

There is a mature commercial market for first generation biofuels. Biofuels from commercially available technology are more prospective in regions where energy crop production is feasible: for example, sugar cane in subtropical areas of South America and sub-Saharan Africa, and sugar beet in more temperate regions such as the United States, Argentina and Europe. In the longer term, lignocellulosic crops could provide bioenergy resources for second generation biofuels which are considered more sustainable, provide land use opportunities and will reduce the competition with food crops.

### Primary energy consumption

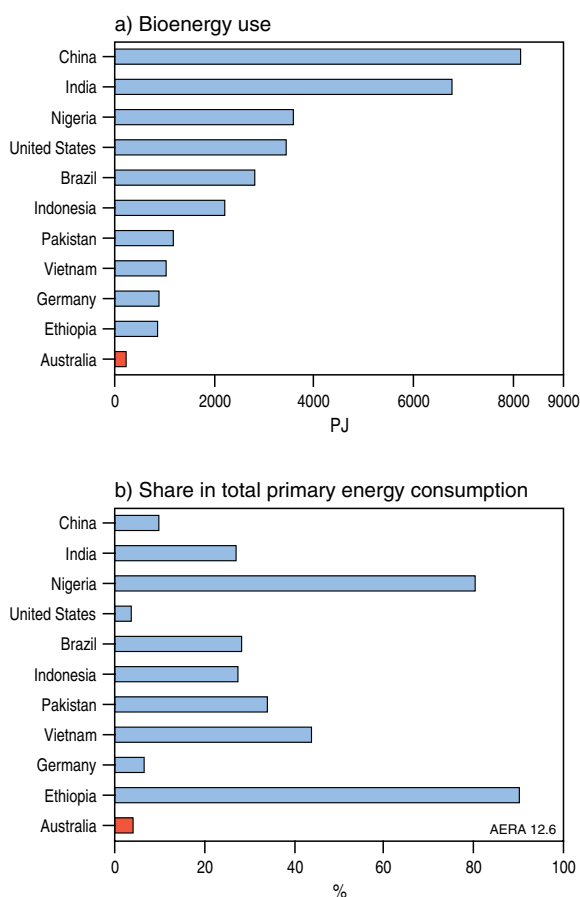
World primary consumption of bioenergy was 48 980 PJ in 2007 (table 12.1). From 2000 to 2007 world bioenergy use increased at an average rate of 1.9 per cent per year. OECD countries accounted for 19 per cent (9317 PJ) of world bioenergy consumption; however the average rate of growth in consumption was 3 per cent per year from 2000 to 2008, faster than the world average.

In 2007, China was the largest user of bioenergy, consuming 8145 PJ, followed by India (6771 PJ) and Nigeria (3582 PJ) (figure 12.6). The majority of



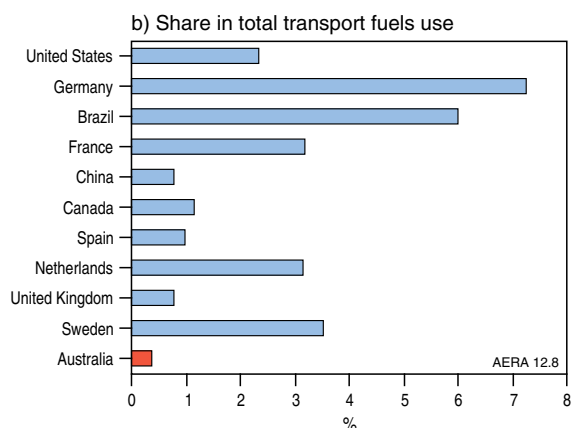
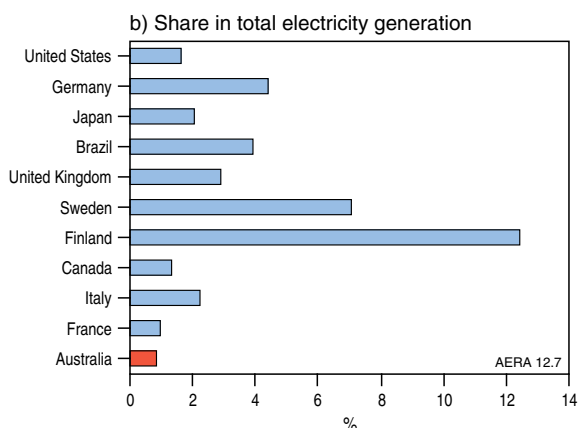
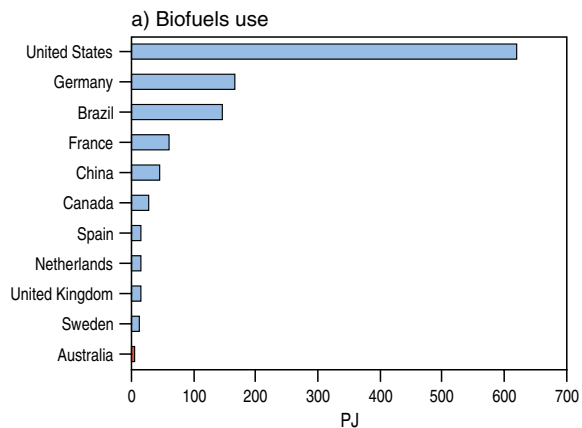
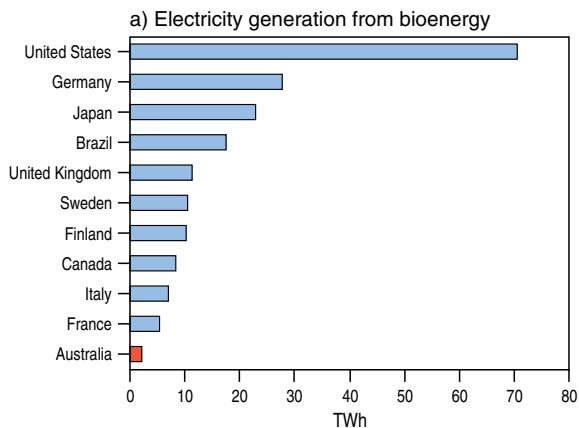
**Figure 12.5** Share of biomass sources in the world primary bioenergy mix in 2007

Source: IEA Bioenergy 2009a



**Figure 12.6** Primary consumption of bioenergy, by country, 2007

Source: IEA 2009a



**Figure 12.7** Electricity generation from bioenergy, by country, 2007

Source: IEA 2009a

**Figure 12.8** Biofuels use for transport, by country, 2007

Source: IEA 2009a

bioenergy use in China, India and Nigeria is solid biomass used in the residential sector. Bioenergy represented a relatively small proportion of China's total primary energy consumption, with a share of 10 per cent, while Nigeria's bioenergy use represented 80 per cent of its total primary energy consumption and Ethiopia's bioenergy use represented 90 per cent of its energy consumption (figure 12.6).

### Electricity generation

A small proportion of the world's electricity generation is sourced from bioenergy. In 2007, the global share of bioenergy in total electricity generation was only 1.3 per cent (table 12.1). Despite its small share, electricity generated from bioenergy increased at an average rate of 6 per cent per year from 2000 to 2007, to reach 255 TWh.

In some countries, the share of bioenergy in total electricity generation is significantly higher than the world average. Finland had a bioenergy share of electricity generation of more than 12 per cent in 2007 (figure 12.7). The United States is the largest contributor to total world electricity generation from bioenergy, followed by Germany and Japan.

While bioenergy use is higher in non-OECD countries, it is of considerably more significance for electricity generation in OECD countries. Bioenergy for electricity generation represents 17 per cent of total bioenergy consumption in OECD countries, compared to only 1 per cent in non-OECD countries (IEA 2009a).

Worldwide primary solid biomass is the major bioenergy fuel used for electricity generation. In 2007, electricity generated from solid biomass represented 62 per cent of bioenergy electricity, while biogas represented 11 per cent and waste represented the remaining 27 per cent of electricity from bioenergy.

### Transport biofuels

The United States is the world's largest consumer of biofuels, using 619 PJ in 2007 (figure 12.8). However, biofuels represent only 2.3 per cent of total transport fuels use in the United States. Germany and Brazil follow the United States as large biofuels users. Biofuels represent a larger share of total transport fuels use in Germany and Brazil, 7.2 per cent and 6.0 per cent, respectively.

### Trade

The increase in demand for biomass feedstock (e.g. wood chips, vegetable oils and agricultural residues)

and bioenergy commodities (e.g. ethanol, biodiesel and wood pellets) has seen the rapid growth in international trade (IEA Bioenergy 2009b). The main biomass feedstocks and bioenergy commodities traded and the trade routes include:

- ethanol from Brazil to Japan, United States and western Europe;
- wood pellets from Canada, United States and eastern Europe to western Europe; and
- palm oil and agricultural residues from Brazil and Southeast Asia to western Europe.

In addition, there is a substantial amount of trade within Europe.

### World market outlook for bioenergy to 2030

Bioenergy use is projected by the IEA to increase moderately to 2030, with transport biofuels growing at a slightly faster rate than electricity generation from bioenergy. Among non-transport uses, an increasing proportion of bioenergy is projected to be devoted to electricity generation rather than direct burning of biomass, in line with growing electricity demand, particularly in non-OECD countries.

Global demand for bioenergy resources is expected to increase with the projected growth in bioenergy use. In the short-term, demand for bioenergy resources are likely to be met by sugar, starch and

oilseed crops, as well as utilising the large volumes of unused residues and wastes. Lignocellulosic crops are expected to contribute in the medium- to long-term. Algae could make a significant contribution in the longer term (IEA Bioenergy 2009b).

### Electricity and heat generation

The IEA projects world electricity generation from bioenergy to increase to 839 TWh by 2030, growing at an average rate of 5.3 per cent per year (table 12.2). The share of bioenergy in electricity generation is not projected to increase significantly, reaching only 2.4 per cent in 2030, from 1.3 per cent currently. Electricity generation from bioenergy is projected to increase at a faster rate in non-OECD countries than in OECD countries, although from a smaller base.

The biggest increases in electricity generation from bioenergy are projected to occur in the United States, Europe and China. The costs of power generation from renewables, including bioenergy, are expected to fall over time as a result of increased deployment.

### Transport biofuels

Worldwide use of biofuels is projected to increase at an average rate of 6.9 per cent per year to 5568 PJ by 2030 (table 12.3). In non-OECD countries, biofuels use is projected to increase at an average rate of 11.2 per cent per year, whereas it is projected to increase

**Table 12.2** IEA reference case projections for world bioenergy electricity generation

	unit	2007	2030
<b>OECD</b>	TWh	217	492
Share of total	%	2.0	3.7
Average annual growth, 2007–2030	%	-	3.6
<b>Non-OECD</b>	TWh	41	347
Share of total	%	0.5	1.6
Average annual growth, 2007–2030	%	-	9.7
<b>World</b>	TWh	259	839
Share of total	%	1.3	2.4
Average annual growth, 2007–2030	%	-	5.2

Source: IEA 2009b

**Table 12.3** IEA reference case projections for transport biofuels consumption

	unit	2007	2030
<b>OECD</b>	PJ	963	3056
Share of total	%	1.9	5.8
Average annual growth, 2007–2030	%	-	5.1
<b>Non-OECD</b>	PJ	461	2512
Share of total	%	1.0	2.9
Average annual growth, 2007–2030	%	-	7.6
<b>World</b>	PJ	1424	5568
Share of total	%	1.5	4.0
Average annual growth, 2007–2030	%	-	6.1

Source: IEA 2009b

at a rate of 5 per cent per year in OECD countries. However, the share of biofuels in total transport fuel use is projected to remain at less than 3 per cent in non-OECD countries, while in OECD countries it is projected to increase to almost 6 per cent.

Biofuels use is not expected to increase significantly in the short term. The fall in oil prices at the end of 2008 affected the profitability of biofuels production and led to the cancelling of many planned biofuels projects around the world. Many countries have scaled back their biofuels policies as a result of concerns over the impact of biofuels on food prices, land and water resources and biodiversity, further affecting the profitability of biofuels production.

Biofuels production and use is projected to recover in the longer term, however, aided by second generation production technologies. Second generation biofuels are projected to represent almost 25 per cent of the increase in total biofuels production over the period to 2030 (IEA 2009b).

## 12.3 Australia's bioenergy resources and market

### 12.3.1 Bioenergy resources

Bioenergy resources currently used, potential future resources and the bioenergy outputs are summarised in table 12.4. There is a range of bioenergy resources (feedstocks) available for multiple conversion technologies to generate electricity and heat and produce biofuels. Bioenergy resources are difficult to estimate due to their multiple and competing uses. There are production statistics for current commodities such as grain, sugar, pulp wood and saw logs; however these commodities are currently largely committed to food, animal feed and materials markets. They could be switched to the bioenergy market in certain conditions, but this may not be the highest order use for them.

Australia's potential bioenergy resources are large. There are under-utilised resources in crop residues,

**Table 12.4** Current and future bioenergy resources

Biomass groups	Current resources	Bioenergy		Future resources	Bioenergy	
		P	T		P	T
Agricultural related wastes and by-products	Livestock wastes: <ul style="list-style-type: none"> <li>• manure</li> <li>• abattoir wastes solids</li> </ul> By-products: <ul style="list-style-type: none"> <li>• wheat starch</li> <li>• used cooking oil</li> </ul>	P	T	Crop and food residues from harvesting and processing: <ul style="list-style-type: none"> <li>• large scale: rice husks, cotton ginning, and cereal straw</li> <li>• small scale: maize cobs, coconut husks and nut shells</li> </ul>	P	
Sugar cane	Bagasse, fibrous residues of sugar cane milling process Sugar and C-molasses	P	T	Trash, leaves and tops from harvesting	P	
Energy crops	High yield, short rotation crops grown specifically: <ul style="list-style-type: none"> <li>• sugar and starch crops</li> <li>• oil bearing crops – sunflower, canola, juncea and soya beans</li> </ul>		T	Woody crops (oil mallee) GM crops Tree crops Woody weeds (e.g. Camphor Laurel) New oilseed (Pongamia) and sugar (agave) crops Algae (micro and macro)	P	T
Forest residues	Wood from plantation forests	P		Wood from plantation forests and native forestry operations	P	T
Wood related waste	Saw mill residues: <ul style="list-style-type: none"> <li>• wood chips and saw dust</li> </ul> Pulp mill residues: <ul style="list-style-type: none"> <li>• black liquor and wet wastes</li> </ul>	P				
Urban solid waste		P		Food related wastes, garden organics, paper and cardboard material and urban timber	P	
Landfill gas	Methane emitted from landfills mainly municipal solid wastes and industrial wastes	P				
Sewage gas	Methane emitted from the solid organic components of sewage	P				

**Note:** P = electricity and heat generation; T = transport biofuel production

**Source:** Batten and O'Connell 2007; Clean Energy Council 2008



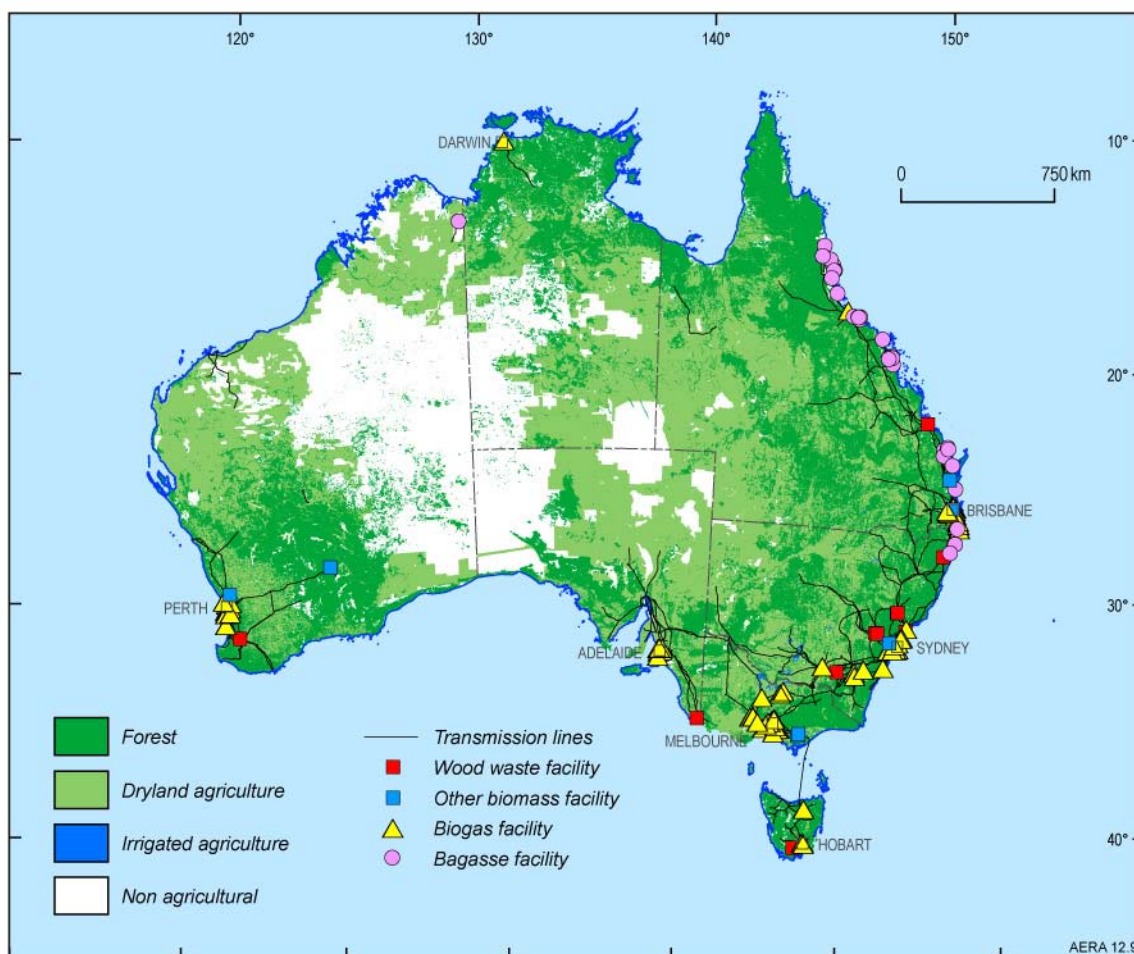
plantation and forest residues and waste streams. There is a significant expansion into a new range of non-edible biomass feedstocks with the development of second generation technologies. Potential feedstocks of the future include modifying existing crops, growing of new tree crops and algae.

There are many factors to be taken into account for each bioenergy resource, such as moisture content, resource location and distribution, and type of conversion process. Different sources of biomass have very different production systems and therefore can involve a variety of sustainability issues. These range from very positive benefits (e.g. use of waste material, or growing woody biomass on degraded agricultural land) through to large scale diversion of high input agricultural food crops for biofuels (O'Connell et al. 2009a). There is also a range of potential impacts on the resources including drought, flood, fire, climate change and energy prices. Future biomass feedstocks from agricultural production are dependent on whether production areas expand or reduce or yields increase.

The proportion of biomass potentially available will depend on the value of biomass relative to competing uses, impact of their removal (retention of biomass in situ returns nutrients to soil, improves soil structure and moisture retention), and global oil prices. The right economic conditions may result in some of the biomass potentially being used for bioenergy production. Depending on the price point, biomass may be diverted to biofuels or electricity generation – sawmill residues otherwise sold for garden products, for example, or pulpwood chipped and exported or used for paper production may be diverted to bioenergy if it is a higher value product.

### Electricity and heat generation

Current bioenergy resources used for generating electricity and heat are predominantly from agricultural wastes and by-products, wood waste, landfill and sewage facilities (figure 12.9). The Clean Energy Council (2008) identified significant potential for growth in bioenergy production from waste streams, such as landfill and sewage gas and urban waste.



**Figure 12.9** Distribution of bioenergy electricity and heat generation facilities

**Note:** Areas depicted as under irrigation are exaggerated for presentation

**Source:** Geoscience Australia and Bureau of Rural Sciences

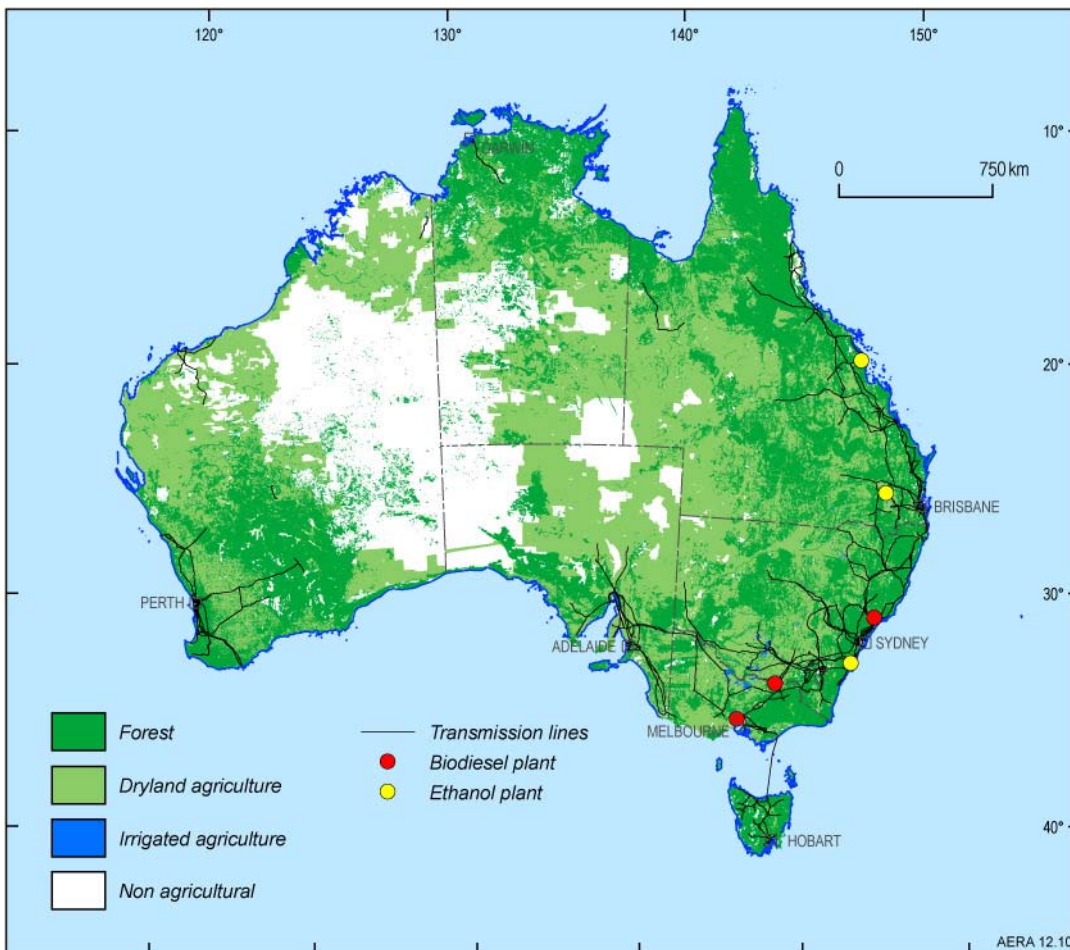
**Agricultural related wastes** in total are a very large resource. However, the resources are widely dispersed and can have a range of alternative uses including composting for garden product manufacture and stockfeed for animals. Currently, the bulk of biomass resources are not collected as a feedstock for bioenergy.

The sugar cane industry is one of few industries self sufficient in energy, through the combustion of bagasse in cogeneration plants. The sugar mill directly consumes the heat and electricity generated and any surplus steam is used to generate electricity and fed into the power grid. The industry is located mainly in coastal Queensland, with a few mills in northern New South Wales. The total annual sugar cane crop is about 35.5 million tonnes (Mt), of which 14 per cent is cane fibre, resulting in a total available energy of above 90 PJ (Clean Energy Council 2008). Currently, the energy generation is dependent on the crushing periods and the availability of bagasse resources. There is potential to increase electricity generation efficiency with integrated gasification combined cycle technology and expand the biomass

feedstock to include sugar cane trash, tops and leaves.

Other agricultural waste streams, including manure from livestock raised or yarded in concentrated areas, are suitable for generating bioenergy. Waste material can be used to produce stationary energy and assist in reducing environmental problems from waste disposal, methane emissions and pollution of water supplies.

**Wood waste and forest residues** are only used in a few bioenergy plants in Australia for generating electricity. For the purposes of resource assessment, it is assumed that native forest wood waste will remain constant; the potential from plantations may increase in line with plantation expansion. Wood related waste for energy generation, while having economic benefits, also has to be managed in terms of environmental considerations. In Australia, governments at all levels, have established regulatory mechanisms, including Regional Forest Agreements, as well as other specific provisions under the Renewable Energy Target concerning the eligibility for forest wood waste for bioenergy use



**Figure 12.10** Distribution of biofuel plants

**Note:** Areas depicted as under irrigation are exaggerated for presentation

**Source:** Geoscience Australia and Bureau of Rural Sciences

in order to manage the sustainable use of these products. These regulatory frameworks place some limitations on the use of wood waste in Australia for electricity generation.

The use of **landfill gas** (mainly methane) to generate electricity is a relatively mature technology, which involves installing a network of perforated pipes into an existing landfill and capturing the gas generated from waste decomposition. The captured gas is used to generate electricity using reciprocating gas engines. Most facilities are centred near the major urban centres and used locally.

Bioreactor landfill technology accelerates the rate of waste decomposition maximising gas production by recirculating water through a specially designed landfill. This technology is being used at the Woodlawn Bioreactor, a disused open cut mine in New South Wales. The site accepts 300 000 tonnes of sorted residual waste per year and will ultimately support up to 25 Megawatts (MW) of generation capacity.

**Sewage gas** can be collected at treatment plants to generate electricity and heat. Organic waste is fed into an anaerobic digester to produce a methane-rich biogas then combusted in customised gas engines or gas turbines. Thermal energy produced by the engine during combustion is recovered and used to heat the anaerobic digestion process.

### Transport biofuels

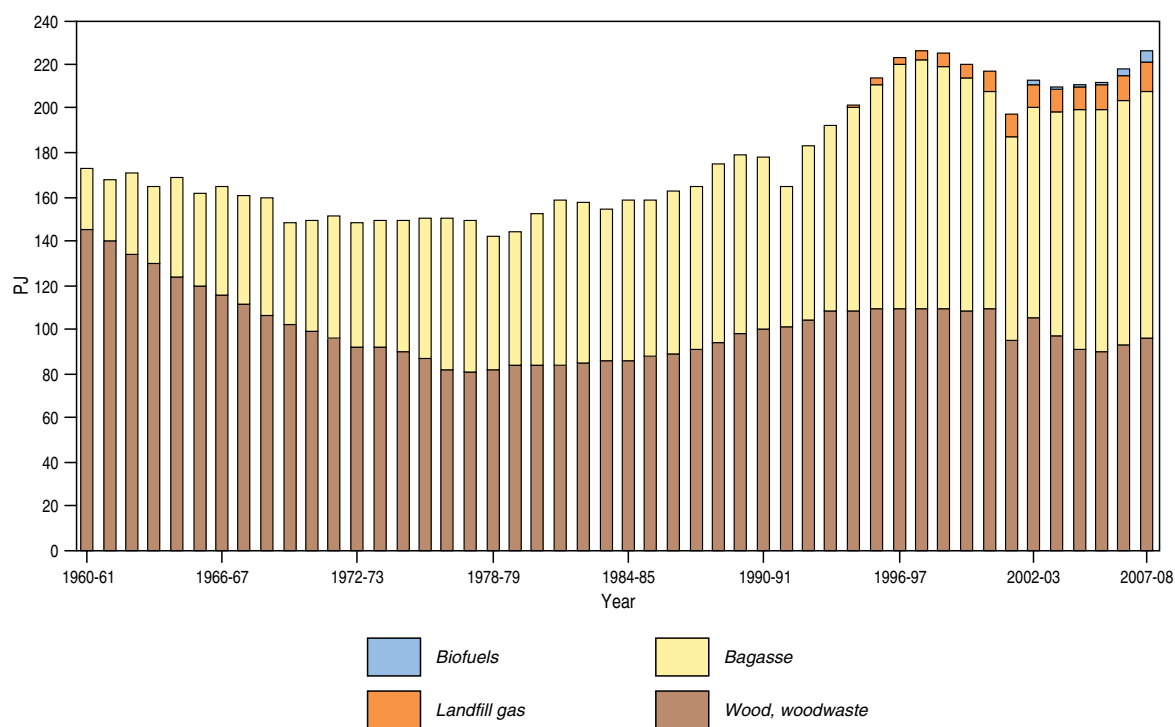
As at late 2009, there are three major ethanol plants and three major biodiesel plants in operation, with a total production capacity of about 330 million litres (ML) and 175 ML, respectively (figure 12.10). Ethanol production is from C-molasses from sugar processing, grain (mainly sorghum) and starch from flour milling. Biodiesel production is from tallow and used cooking oil. Biodiesel production is constrained by a limited availability of low cost feedstocks, which are by-products or waste streams.

### 12.3.2 Bioenergy market

#### Primary energy consumption

Bioenergy accounted for 78 per cent of Australia's renewable energy use but only 4 per cent of Australia's primary energy consumption in 2007–08. Over the decade from 1999–2000 to 2007–08, bioenergy use increased at an average rate of only 0.3 per cent per year. In Australia, production and consumption of bioenergy are about equal, because there is currently only very small trade of bioenergy. In mid 2009 Australia's largest exporter of wood pellets secured two three-year contracts, totalling \$130 million to supply Europe. The wood pellets will be used in co-firing plants and home heating markets.

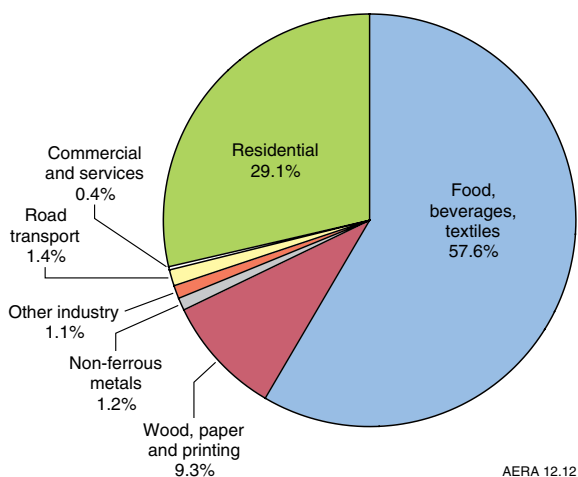
The majority of Australia's bioenergy is from wood and wood waste and bagasse. Australia's use of wood and wood waste, predominately for direct heat



AERA 12.11

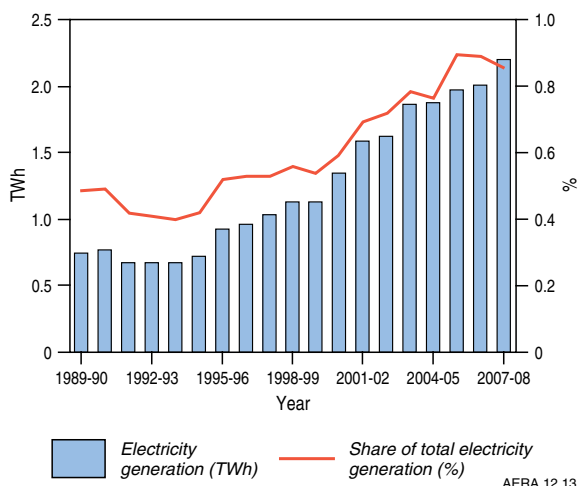
**Figure 12.11** Australia's primary consumption of bioenergy

Source: ABARE 2009a



**Figure 12.12** Australian bioenergy use, by industry, 2007-08

Source: ABARE 2009a



**Figure 12.13** Australian electricity generation from bioenergy

Source: ABARE

application, has declined over time. In the 1960s wood use represented between 70 and 85 per cent of total bioenergy use, but as bagasse use expanded, this share declined to 55-65 per cent in the 1970s and remained relatively constant in the 1980s and 1990s.

In 2007-08, bagasse and wood represented 50 per cent and 42 per cent of bioenergy use, respectively. Landfill and sewage gas represented 6 per cent of total bioenergy use and liquid biofuels comprised the remaining 2 per cent (figure 12.11).

### Bioenergy use, by industry

Around 58 per cent of Australia's bioenergy is used in the food and beverages sector, specifically within the sugar industry, which uses bagasse from its sugar production to generate electricity and heat. The residential sector is the second largest bioenergy user, accounting for 29 per cent of bioenergy use (figure 12.12). This is in the form of wood used

predominantly for heating. There are also small amounts of bioenergy used in the transport and commercial and services sectors.

### Electricity generation

In 2007-08, wood and wood waste and landfill and sewage biogas fuel inputs to public electricity generation (excluding cogeneration) were 19.7 PJ, which generated 2.2 TWh of electricity. In addition, 112 PJ of bagasse were used as fuel within the food, beverages and textiles sector, the majority of which is used in sugar refineries in cogeneration plants.

The contribution of wood, wood waste and biogas to Australia's electricity generation has increased over the past two decades. From 1989-90 to 2007-08 bioenergy electricity generation grew at an average rate of 6 per cent per year. The share of bioenergy in total electricity generation increased modestly from 0.5 per cent to 0.8 per cent over that period (figure 12.13).

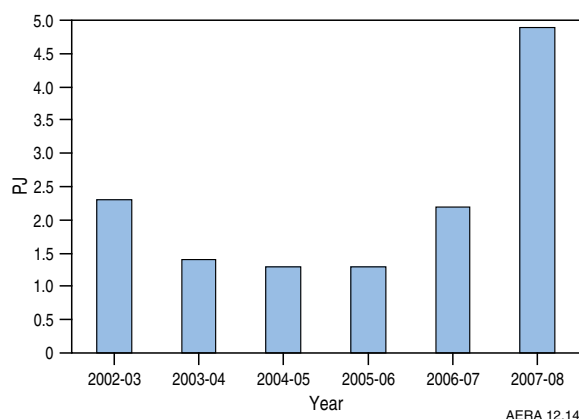
**Table 12.5** Capacity of electricity generation from bioenergy (MW), 2009

	Biogas	Bagasse	Wood waste	Other bioenergy <sup>b</sup>	Total bioenergy
New South Wales <sup>a</sup>	73	81	42	3	199
Victoria	80	0	0	34	114
Queensland	19	377	15	4	415
South Australia	22	0	10	0	32
Western Australia	27	6	6	63	102
Tasmania	4	0	0	0	4
Northern Territory	1	0	0	0	1
<b>Australia</b>	<b>226</b>	<b>464</b>	<b>73</b>	<b>104</b>	<b>867</b>
Share of total renewable electricity capacity (%)	2.2	4.4	0.7	1.0	8.3

<sup>a</sup> Includes the ACT. <sup>b</sup> Unspecified biomass and biodiesel

Source: Geoscience Australia 2009





**Figure 12.14** Australian biofuels production

Source: ABARE 2009a

**Table 12.6** Biofuels production in Australia

	2005-06	2006-07	2007-08	2008-09
	ML	ML	ML	ML
Biodiesel	21	54	50	85
Ethanol	42	84	149	209
<b>Total</b>	<b>63</b>	<b>138</b>	<b>199</b>	<b>294</b>

Source: Department of Resources, Energy and Tourism

The total capacity of electricity generation from bioenergy represented 1.6 per cent of all electricity generation capacity in 2008. Bagasse-fuelled electricity generation facilities represent 54 per cent of total bioenergy capacity, at 464 MW. These facilities are located predominantly in Queensland where sugar production plants are located (table 12.5).

In contrast, biogas-fuelled plants at landfill and sewage facilities are centred near major urban centres across all states and territories. These sites comprise a total installed capacity of 226 MW. Wood waste facilities represent 0.7 per cent of renewable energy capacity and have a total capacity of 73 MW (table 12.5).

#### Transport biofuels

Biofuels comprised about 0.5 per cent of Australia's transport fuel supply in 2007-08. Australian biofuels production decreased by about 40 per cent from 2002-03 to 2004-05 to 1.3 PJ. However, from 2004-05 to 2007-08 biofuels production increased almost fourfold to 4.9 PJ (figure 12.14).

In 2007-08, Australia's ethanol production is estimated at 149 ML and biodiesel production at 50 ML. Ethanol production has increased as a result of the new Dalby plant in Queensland and a small expansion at the Manildra plant in New South Wales. In 2008-09 ethanol production increased to 209 ML. Biodiesel production fell slightly from 2006-07 to 2007-08, due to three plants temporarily halting production in 2007 and 2008 (table 12.6). In 2008-09, biodiesel is estimated to have increased to about 85 ML.

There are currently three major ethanol plants in operation. The largest operator is Manildra Group in New South Wales with total production capacity of 180 ML. Three major biodiesel plants are in production with a total production capacity of 175 ML. The total operating biofuels production capacity in Australia is around 600 ML a year (table 12.7).

**Table 12.7** Liquid biofuels production facilities in Australia, 2009

Location	Capacity ML/yr	Feedstocks
<b>Fuel ethanol</b>		
Manildra Group, Nowra, NSW	180	Waste wheat starch, some low grade grain
CSR Distilleries, Sarina, Qld	60	C-molasses
Dalby Biorefinery, Dalby, Qld	90	Sorghum
<b>Total</b>	<b>330</b>	
<b>Biodiesel</b>		
Biodiesel Industries Australia, Maitland, NSW	15	Used cooking oil, vegetable oil
Biodiesel Producers Limited, Wodonga, Vic	60	Tallow, used cooking oil
Smorgon Fuels, Melbourne, Vic	100	Dryland juncea (oilseed crop), tallow, used cooking oil, vegetable oil
Various small producers	5	Used cooking oil, tallow, industrial waste, oilseeds
<b>Total</b>	<b>180</b>	
<b>Biodiesel plants with limited production</b>		
Australian Renewable Fuels, Adelaide, SA	45	Tallow
Australian Renewable Fuels, Picton, WA	45	Tallow
<b>Total</b>	<b>90</b>	
<b>Biodiesel plants not in production</b>		
Eco-Tech Biodiesel, Narangba, Qld	30	Tallow, used cooking oil

Source: Department of Resources, Energy and Tourism



**Table 12.8** Bioenergy projects recently developed, as at September 2009

Project	Company	State	Type	Start up	Capacity (MW)
<b>Electricity and heat generation</b>					
Tumut	Visy Paper	NSW	Wood waste	2001	17.0
Rocky Point	National Power and Babcock and Brown Joint Venture	QLD	Bagasse	2001	30.0
Stapylton	Green Pacific Energy	QLD	Wood waste	2003	5.0
South Cardup	Landfill Management Services Ltd	WA	Landfill methane	2005	6.0
Werribee (AGL)	AGL	VIC	Sewage methane	2005	7.8
Pioneer 2	CSR Sugar Mills	QLD	Bagasse	2005	63.0
Woodlawn	Woodlawn Bioreactor Energy Pty Ltd	NSW	Landfill methane	2006	25.6
Carrum Downs 1 & 2	Melbourne Water	VIC	Sewage methane	2007	17.0
Eastern Creek 2	LMS Generation Pty Ltd	NSW	Landfill methane	2008	8.8
Condong	Sunshine Electricity	NSW	Bagasse	2008	30.0
Broadwater	Sunshine Electricity	NSW	Bagasse	2008	30.0
<b>Transport biofuels</b>					
Dalby	Dalby Biorefinery Ltd	QLD	Ethanol	2008	90.0

Source: Geoscience Australia; ABARE

### Recent bioenergy projects

Eleven bioenergy electricity projects have been commissioned in Australia since 2001, with a combined capacity of 240.2 MW (table 12.8). Bagasse-fuelled bioenergy plants accounted for most of the commissioned capacity. Australia's largest recently commissioned bioenergy plant is CSR Sugar Mills in Queensland with a capacity of 63 MW.

Australia's first grain to ethanol plant at Dalby, Queensland commenced operation in December 2008. The plant processes 220 000 tonnes of dry grain (sorghum) as its feedstock with a capacity of 90 ML of ethanol per year.

## 12.4 Outlook to 2030 for Australia's resources and market

There is significant potential to expand the use of biomass for electricity, heat and transport biofuels production. There is a diversity of bioenergy resources and conversion technologies that can provide greenhouse gas emissions savings and reduce waste disposal issues. There may be opportunities for the bioenergy sector to support agricultural industries and rural communities through growing complementary energy crops and in developing regional energy facilities.

### 12.4.1 Key factors influencing the outlook

The future growth of Australia's bioenergy industry will depend on its competitiveness against other energy sources, the commercialisation of efficient conversion technologies and availability of bioenergy resources.

The cost competitiveness of bioenergy with alternative electricity generation and transport fuels

will depend on the cost of resources (both bioenergy and alternatives), conversion technologies and relevant government policies, particularly those that affect both the availability of resources and their price.

Cost factors aside, the growth of the bioenergy industry will be influenced by the commercialisation of second generation technologies, which will also increase the range of bioenergy resource options and reduce competition for resources between bioenergy feedstocks and agricultural/forestry commodities. Development of effective harvesting and processing methods and improved transportation and storage will also be important factors in achieving efficiencies in bioenergy production.

Availability of biomass will be central to the expansion of the bioenergy sector. The availability of biomass is influenced by:

- diversion of current biomass production and waste and residues streams. Biomass residues from forestry, agricultural harvest and processing, and waste streams, such as landfill and sewage gas, offer a large under-utilised energy resource, which can also assist in waste disposal issues;
- change in harvesting regimes for crops or forests (e.g. stubble from agricultural lands and thinnings from forests); and
- new production systems which may include land use change, in turn influenced by available land, crop or forest types and productivity. The amount of land available for biomass depends on the amount of land used for agricultural and forestry products and that devoted to nature reserves. The demand for food, which is a function of population and diet, has a direct impact on land

use and availability to grow primary biomass resources for bioenergy. The amount of biomass produced is a function of the quality of the land, the climate, water availability and management practices.

There are potential risks in the expansion of biomass production into areas that provide valuable ecosystems that support high biodiversity and may result in nutrient pollution.

### Cost competitiveness

Bioenergy production costs are a function of biomass feedstock, labour, transportation, capital and operating costs.

The cost of feedstocks depends on whether it is a primary biomass (energy crop) or residue biomass from an agricultural, forestry or urban activity. Cost variations are due to input and harvest costs from production systems. Solid biomass can be bulky, difficult to handle and transport, and may decay over time. Onsite pre-processing of materials, such as chips or wood pellets, may increase the labour and processing costs, but reduce transport and storage costs.

Bioenergy becomes a competitive alternative in situations where cheap or 'negative-cost' residues or wastes are available and used onsite (IEA Bioenergy 2007). The most economical bioenergy production model is the production of energy at the biomass location such as at landfill and sewage sites, paper mills, sawmills or sugar mills. In Australia, a large proportion of bioenergy production occurs in small to medium cogeneration plants built at sugar mills and other food processing plants that have access to significant low cost biomass waste streams.

Large scale bioenergy production requires further development in conversion technologies and biomass production to be competitive with fossil fuels (IEA Bioenergy 2007).

### Electricity and heat generation

Electricity and heat generation through biomass combustion is a mature, efficient and reliable technology. In cases where low cost feedstocks are available for co-firing schemes, electricity and heat production from bioenergy is cost competitive with fossil fuels (IEA Bioenergy 2007).

An assessment of the electricity generation costs from biomass was undertaken by IEA Bioenergy (2007), which provides a comparison for three biomass types. It should be noted that the actual costs may not be directly applicable to Australia. In the short term (about 5 years) the costs of generating electricity range from €0.03–0.15 (US\$0.04–0.21)/kilowatt hour (kWh) (in 2007 dollars), depending on the biomass feedstock, technology and scale of generation plant (table 12.9). In the longer term (more than 20 years) biomass electricity costs are expected to decline to €0.02–0.08 (US\$0.03–0.11)/kWh (in 2007 dollars) with advances in technologies. The main variability in costs will arise from the cost of biomass supply.

A relatively low capital cost option for improving system efficiency and reducing carbon emissions is retrofitting of co-firing boilers with biomass delivery systems. Total costs vary depending on the type and condition of the boiler being modified and the biomass delivery system, with separate feed systems costing up to four times as much as a blended delivery system (Grabowski 2004). In the United States, the annual fuel costs are often lower in co-firing plants than in plants burning pure coal. These annual savings can result in payback periods on initial investment of less than 10 years and reduce production costs between \$US0.02–0.22/kWh. In addition, the use of biomass as a supplementary fuel in coal-fired plants reduces sulphur dioxide and nitrogen oxides emissions (EESI 2009a).

**Table 12.9** Electricity generation costs for three bioenergy resources

Biomass	Electricity generation	
	Short term	Longer term
Organic waste • municipal solid waste	Less than €0.03–0.05 (US\$0.04–0.07)/kWh For state-of-the-art incineration and co-combustion technology	Similar range Improvements in efficiency and environmental performance
Residues • forests • agriculture	€0.04–0.12 (US\$0.05–0.16)/kWh Lower cost in combined heat and power operations Major variable is biomass supply costs	€0.02–0.08 (US\$0.03–0.11)/kWh Major variable is biomass supply costs
Energy crops • oilseeds • sugar/starch • short rotation cropping trees	€0.05–0.15 (US\$0.07–0.21)/kWh High costs for small scale plants, lower costs for large scale (over 100 MW) state-of-the-art combustion	€0.03–0.08 (US\$0.04–0.11)/kWh Low costs due to advanced co-firing schemes and integration gasification using combined cycle technology over 100 MW

**Note:** Costs in 2007 dollars

**Source:** IEA Bioenergy 2007

### Transport biofuels

The main component of biofuels production costs is the cost of feedstock, which varies considerably according to the type of feedstock used. Low cost biofuels can be produced from crops grown in the most suitable climate zones and using commercially available technologies, such as ethanol from sugar cane grown in tropical regions. Biofuel production costs are low in Brazil, for example, largely because of the availability of low cost sugar cane. Sugar cane ethanol in Brazil has a lower cost than petrol (Worldwatch Institute 2006). Ethanol production costs vary significantly subject to the location and the feedstock used. Sugar cane ethanol produced in Brazil costs about US\$0.20 per litre, whereas in the United Kingdom costs were about US\$0.81 per litre (IEA 2006b).

The production cost of first generation biofuels in Australia is highly variable due to variations in the cost of feedstock. Ethanol from starch waste and C-molasses and biodiesel from used cooking oil can be produced at a cost less than A\$0.45 per litre, in 2007 dollars (comparative cost of oil at US\$40 per barrel). Ethanol from sugar and grain and biodiesel from tallow and oilseed crops (canola) can be produced from less than A\$0.80 per litre, in 2007 dollars (comparative cost of oil at US\$80 per barrel) (O’Connell et al. 2007).

In Australia, expansion and construction of first generation biofuel facilities were planned in 2007 as a result of government subsidies and high oil prices. However, many of these plans were postponed due to high feedstock prices and falling crude oil prices at the end of 2008. Uncertainty about future changes in oil and feedstock prices continues to restrict investment in new capacity.

The development of second generation biofuels from lignocellulosic biomass will not only increase the range of low cost feedstocks but will increase conversion efficiencies and lower production costs (IEA Bioenergy 2007).

The cost of second generation lignocellulosic biofuel production is estimated to be less than US\$1.00 per litre. Cost is expected to decrease to between US\$0.55 and US\$0.70 per litre in the long-term depending on the technologies and improvements

**Table 12.10** Production costs for second generation biofuels

Second generation technologies	Production cost US\$/litre gasoline equivalent	
	2010	2030
Biochemical ethanol	0.80–0.90	0.55–0.65
Biomass to Liquids (BTL) diesel	1.00–1.20	0.60–0.70

Source: IEA Bioenergy 2008

in techniques, up-scaling of production facilities and lower feedstock cost using biomass residues (table 12.10).

### Technology developments – more efficient, using a greater range of non-edible biomass resources

There is a range of technologies currently available and in development for converting biomass into energy (box 12.1). Energy is released either in the form of heat or is converted into another energy form such as liquid biofuels or biogas.

#### Electricity and heat generation

Electricity and heat are generated by combustion, cogeneration and gasification of biomass and from methane gas captured from landfill and sewage facilities. The burning of solid biomass is the dominant method of energy conversion for electricity and heat production. Increased efficiency can be gained through fluidised bed combustion and co-firing of biomass (e.g. wood residue) with coal. There is potential to increase bioenergy production through utilisation of under-exploited biomass residues and wastes from forestry and wood processing facilities. These residue and waste resources, if used more effectively, can assist in the reduction of greenhouse gas emissions.

#### Transport biofuels

First generation biofuels are mainly produced from sugar and starch by-products, grain oil crops, used cooking oil or animal fat (box 12.2). Given the limited supply of these feedstocks in Australia, first generation biofuels will not be able to supply a large proportion of transport fuel needs until second generation technologies become commercially viable.

Second generation biofuels are the subject of active RD&D (box 12.2). They are produced from lignocellulosic feedstocks such as crop and forest residues and wood processing wastes, which do not compete directly with food crops. In Australia, second generation biofuels show promise for making a greater contribution to transport fuel supply, but this is dependent on sustainable production of biomass at a competitive cost (Wild 2009).

The farming of algae to produce biofuels is an area of active research worldwide. Algae cultivation is not new technology – it has been used to produce food supplements such as beta-carotene, and spirulina. Both microalgae and macroalgae (e.g. seaweed) are being investigated as feedstocks for biofuels. Algae can be grown on non-arable land, in saline and waste water and has a high oil yield. Microalgae can fix CO<sub>2</sub> from the atmosphere, power plants and industrial processes and soluble carbonate, however only a small number of microalgae are tolerant to high levels of sulphur oxides and nitric oxides present in flue gases. There are challenges limiting the commercial

**BOX 12.1** BIOENERGY TECHNOLOGIES FOR ELECTRICITY AND HEAT GENERATION

Thermal conversion uses heat as the dominant mechanism to convert biomass to energy. Combustion is the simplest method by which biomass can be used for energy and has been used for millennia to provide heat. Conventional combustion technologies involve biomass being burnt in the presence of air in a boiler to generate heat to produce hot air, hot water or steam, which is used in a steam turbine to generate electricity.

*Combustion technologies*

The three main biomass combustion conversion technologies are grate boilers, fluidised bed combustion (gasification) and co-firing in utility boilers.

Grate boiler technology is the oldest combustion principle and was the most common design of small-size boilers. It remains popular for relatively small boilers (less than 5 MW) in countries using fuels such as wood pellets, straw and municipal solid waste (IEA 2008).

Fluidised bed combustion uses upward blowing jets of air to suspend solid fuels during the combustion process for increased efficiency. The process controls the supply of oxygen and/or steam. The biomass is devolatilised and combusted to produce a biogas that can be burnt for heat or used in a gas turbine for electricity generation.

There are two main technologies, bubbling fluidised bed (BFB) and circulating fluidised bed (CFB) technologies. BFB combustion offers better temperature control and is more suitable for non-homogeneous biomass. CFB combustion uses pulverised fuel that does not require a high temperature flame and allows better control of the furnace temperature.

Co-firing refers to the simultaneous combustion of a biomass feedstock and a base fuel (e.g. coal) to produce energy. The most common biomass include low value wood, crop residues and municipal waste. Most biomass feedstock must undergo processing before it can be utilised for co-firing (EESI 2009a). Processed solid biomass is added to the co-fired boilers along with the fossil fuel. It helps reduce reliance on a finite resource and can make a significant contribution to CO<sub>2</sub> emission reductions (Massachusetts Technology Collaborative 2009; IEA 2006a).

Biomass co-firing in modern, large scale coal power plants is efficient and can be cost effective. The technique has been successfully demonstrated in more than 150 installations worldwide. About a hundred of these are operating in Europe, around 40 in the United States and a few in Australia. A number of fuels such as crop residues, energy crops and woody biomass have been co-fired. The proportion of biomass in the fuel mix has ranged between 0.5 and 10 per cent in energy terms (IEA 2008).

For co-firing of up to 10 per cent of biomass mixed with coal or fed through the coal feeding system, only minor changes in the handling equipment are needed. For biomass exceeding 10 per cent or if biomass and coal are burned separately, changes in mills, burners and dryers are needed.

The development of biomass fuel preparation and drying technologies such as torrefaction (thermochemical treatment that lowers the moisture content and increases the energy content) and pelletising of biomass, increase the efficiency of plants. In addition, the biomass is very compact, stable and easier to transport, store and handle.

Wood pellets are rapidly becoming an important source of fuel for co-fired plants. Wood pellets or Densified Biomass Fuel (DBF) are manufactured from low value trees and from sawdust and other pulp waste. Wood pellets are increasingly used as a renewable fuel for power generation in countries such as Japan, Canada, South Africa and particularly in Europe. Much of the new generation capacity in Europe is based on dedicated pellet-fuelled combined heat and power plants. European production has been based on both scarce sawmill waste and, increasingly, imports. In Australia, wood pellet use remains limited but supply to the domestic market and export market is expected to increase.

*Cogeneration technology*

In the most efficient electricity generation plant around 30 per cent of the energy in the biomass is converted into electricity; the rest is lost into the air and water. Cogeneration or combined heat and power (CHP) plants have greater conversion efficiencies as they produce both electricity and process heat.

There is a number of different types of cogeneration technology. For many years, all cogeneration installations were based on the use of conventional boilers, with steam turbines for electricity generation. Gas turbine technology has largely superseded steam turbine technology for medium size installation (Saddler et al. 2004). Bagasse, sludge gas from sewage treatment plants and methane from landfill sites are used as fuel in cogeneration plants. Where a cogeneration plant is powered by waste gases, fugitive gases are captured and utilised to drive gas turbines which in turn generate electricity. In Australia, sugar mills run cogeneration plants which are fuelled by bagasse left over after crushing the sugar cane.

*Trigeneration technology*

Trigeneration technology provides cooling in addition to heat and electricity generation. The process waste heat can be usefully applied for heating in winter and, via an absorption chiller/refrigeration,



for cooling in summer. Refrigeration and air-conditioning normally require a compressor driven by electricity. The absorption chiller uses a heat source to provide energy to drive the cooling system. The combination of technologies to convert waste heat into cooling can reduce peak summer electricity consumption and greenhouse gas emissions from air-conditioning by about 25 per cent.

A small scale trigeneration option is an Organic Rankine Cycle (ORC) engine which uses an organic fluid with a low boiling point, rather than steam and hence lower cost involved in gathering heat. A biomass-fired ORC trigeneration system is able to generate electricity and provide heating and cooling demands.

#### *Gasification and pyrolysis technologies (thermochemical processes)*

The use of gasification is more efficient for energy recovery in terms of electricity generation than traditional combustion. In gasification, solid biomass is heated to high temperatures (800–1000°C) in a gasifier and converted to a syngas primarily composed of hydrogen, carbon monoxide, carbon dioxide, water vapour and methane. There are lower amounts of sodium oxides, nitrous oxides and dioxins emissions than in a traditional combustion process.

The syngas can be used in combustion engines (10 kW to 10 MW) with efficiency of 30 to 50 per cent in gas turbines or combined cycles (IEA 2007a). Biomass integrated gasification/gas turbines (BIG/GT) are being developed. Tar elimination is one of the areas of research, which is expected to be overcome

in the medium term. The first integrated gasification combined cycle (IGCC) plant running on 100 per cent biomass (straw) has been successfully operated in Sweden.

Pyrolysis is thermal degradation of biomass to produce bio-oil, syngas and charcoal at medium temperatures (350–800°C) in the absence of air. Pyrolysis encounters technical difficulties which have prevented its implementation on a commercial-scale. These include effective heat transfer between the heat carrier and biomass particles or the quenching of vapours to stop further reactions that result in bio-oil quality variations.

#### *Anaerobic digestion technology*

Anaerobic digestion is a technique used for producing biogas which is used commercially worldwide, especially for waste effluents such as waste water, sewage sludge and municipal solid waste. Anaerobic bacteria digest organic material in the absence of oxygen and produce biogas. Anaerobic processes can be managed in a digester or airtight tank or covered lagoon. There is increasing use of this technology in small scale, off grid applications at the domestic and farm-scale.

In modern landfill sites, methane production ranges between 50 and 100 kg per ton of municipal solid waste (MSW). In general, some 50 per cent of biogas can be recovered and used for power and heat generation. After purification and upgrading, biogas can be used in heat plants and stationary engines, fed into the natural gas grid or used as a transport fuel (compressed natural gas) (IEA 2007b).

development of algae biofuels such as algae species that balances requirements of biofuel production, equipment and structures needed to grow large quantities of algae and the negative energy balance after accounting for water pumping, harvesting and extraction.

Research is being undertaken into production systems such as open ponds and closed loop systems, algal strains and fertilisation with nutrients and CO<sub>2</sub>. Open pond systems (e.g. sewage ponds) require an algae strain that is resilient to wide swings in temperature and pH, and competition from invasive algae and bacteria. In a closed system (not exposed to open air) also referred to as a photobioreactor, nutrient-laden water is pumped through plastic tubes that are exposed to sunlight. Photobioreactors have several advantages over open systems by reducing contamination by organisms blown in by the air, controlled conditions (pH, light, temperature and CO<sub>2</sub>) and preventing water evaporation.

In Australia, there is a number of R&D projects investigating biofuel technologies from microalgae.

In Victoria, the University of Melbourne is researching efficient separation, processing and utilisation of algal biomass. Algal Fuels Consortium is developing a pilot-scale biorefinery in South Australia for sustainable microalgal biofuels. A joint project between Murdoch University, Western Australia, and University of Adelaide, South Australia is working on all steps in the process of microalgal biofuels production, from microalgae culture, harvesting of the algae and extraction of oil for biofuels production. Construction commenced in January 2010 on a pilot plant to test the whole process on a larger scale in Karratha, north-west Western Australia, and is expected to be operational by July 2010.

Third generation technologies are in the R&D stage. The technology involves the development of lignocellulosic biorefineries that produce large volumes of low cost biofuel and the overall process is supported through the production of bioenergy and high value bioproducts. Internationally there is commercial and R&D interest in developing bio-based products from biorefineries. DuPont and the University of Tennessee plan to construct a



**BOX 12.2** BIOFUEL TECHNOLOGIES FOR TRANSPORT

Conversion technologies use a range of biochemical and thermochemical processes to convert biomass into biofuels.

**First generation technologies** use conventional processes, fermentation of sugar and starch crops for ethanol production and trans-esterification of oilseed crops, used cooking oil or animal fat (e.g. beef tallow) for biodiesel. The chemical reaction (trans-esterification) involves reaction of an oily feedstock with an alcohol (methanol or ethanol) and a catalyst to form esters (biodiesel) and glycerol.

Advances in first generation biofuels are focused on feedstocks, such as GM crops, new non-edible oilseeds and new sugar (agave) crops. The use of non-edible oil seed plants, such as *Jatropha*, has been explored as potential feedstock in the Philippines and India. *Jatropha* production may be expanded without directly competing with natural forests or high-value agriculture lands used for food production as it can grow on less fertile land (FAO 2008). In Australia, *Jatropha* is banned as it is an invasive plant. However, there is potential for using other non-edible oilseed plants (e.g. *Pongamia* and *Karanja*).

**Second generation technologies** use biochemical and thermochemical processes to convert lignocellulosic and algae feedstocks to biofuels. Biochemical processes use enzymes and micro-organisms to convert feedstocks to sugar prior to fermentation to produce ethanol, butanol or potentially other fuels. Thermochemical processes use pyrolysis and gasification technologies. Pyrolysis processes produce bio-oil, syngas and biochar. The bio-oil is unstable and requires further refining to produce petrol, biodiesel and other high value chemicals. Gasification methods produce syngas, which can be further processed using Fischer-Tropsch synthesis to produce syndiesel and aviation biofuels.

In Australia, R&D into second generation technologies and feedstocks for biofuels is being undertaken (section 12.4.3). CSIRO's Energy Transformed Flagship is conducting research into the potential for a sustainable and economically viable second generation biofuels industry. It has a research program covering sustainable biomass production, thermochemical conversion, enzymatic conversion and algal fuels (CSIRO 2009).

pilot-scale biorefinery in Tennessee, United States (The University of Tennessee 2009). The National Renewable Energy Laboratory in the United States is involved with six major biorefinery development projects that are focused on integrating the production of biomass-derived fuels and other products in a single facility (National Renewable Energy Laboratory 2009).

Currently in Australia, only a few companies are pursuing the lignocellulosic biorefinery model. The Oil Mallee project successfully uses Mallee eucalypts for producing eucalyptus oil, activated carbon and bioenergy from 1 kW integrated wood processing demonstration plant in Narrogin, Western Australia (Oil Mallee Association 2009). The Mallee eucalypts are planted as a complementary crop on land used for growing grain. The re-sprouting ability of the Mallee eucalypts allow for coppicing (harvesting of branches) every second year indefinitely without replanting. It also provides an environmental benefit as the deep mallee roots soak up ground water and assist in mitigating dryland salinity (Oil Mallee Association 2009).

#### **Biomass resources – reliable and environmentally sustainable supply**

Biomass production is a significant potential source of renewable energy that can provide greenhouse gas reduction benefits when replacing fossil fuels. However, a key factor in the growth of the bioenergy sector is

the sustainable management of biomass exploitation and the avoidance of potential negative environmental impacts of bioenergy feedstocks production.

The expansion of the bioenergy industry can provide greenhouse gas savings and other environmental benefits, such as improved biodiversity as well as opportunities for social and economic development in rural communities. The greenhouse gas savings depend on the biomass feedstock cultivation method, changes in land use, the quantity of fossil fuel inputs and the technology used. Waste and residue biomass does not require significant energy input and generally has lower greenhouse emissions when compared to energy crops.

However, the expansion of bioenergy production creates some challenges, such as potential competition for land use, and biomass use for food and stockfeed and potential impacts on biodiversity. As already noted, the availability of biomass is also influenced by population growth, diet, water availability, agricultural density and the environment (Hoogwijk 2006).

Energy crops are dependent on land being available that is not being used for forestry and agricultural products, environmental protection or urban areas. The amount of biomass produced (crop productivity) is a function of the quality of the land, the climate, water resources and management practices. Increased use of fertilisers and pest control to

improve crop yields may lead to increased pollution from nutrient and biocides/pesticides.

Residues from forests and wood processing and organic waste streams are large untapped resources, and effective and sustainable use of these resources can make a contribution to energy supply while reducing waste disposal problems and avoiding the potential environmental impacts of dedicated bioenergy crops.

#### *Electricity and heat generation*

In Australia, bioenergy for electricity and heat generation is produced predominantly from by-products of sugar production and waste streams. Future energy crops may include tree crops, woody weeds and algae as well as expansion into crop and food residues. The main factors are technology costs, reliable supply and consistent quality of biomass.

In urban regions, capturing waste gas from landfill and sewage facilities provides dual benefits of generating bioenergy and eliminating methane emissions. The waste stream supplies to these facilities are relatively constant and if waste gases are not collected and used for bioenergy production, the gas would be flared or vented into the atmosphere. Generation of electricity and heat from biogas will reduce emissions and can replace the use of fossil fuels as clean, cost effective, renewable energy.

Similarly, conversion of animal wastes to biogas can also provide energy and reduce environmental problems associated with animal wastes. The anaerobic digestion process can control manure odour and reduce harmful water run-off.

The Berrybank piggery near Ballarat, Victoria has a 0.225 MW plant that has been generating 3.5 MWh of electricity per day from animal manure since 1991. The Clean Energy Council (2008) estimates that about half of the existing pig herd in Australia is at piggeries of sufficient scale to allow economic implementation of energy generation from the waste stream, with a long-term potential from this industry of about 200 Gigawatt-hours (GWh) per year.

Forestry and agricultural residue and wood waste bioenergy plants rely on a constant supply and consistent grade of biomass. Wood waste for electricity generation is predominantly by co-fired coal plants. Forest residues, wood process wastes and municipal solid wastes have the potential to be used as lignocellulosic feedstock in second generation technologies.

#### *Transport biofuels*

First generation biofuels from energy crops are constrained by the amount of land available and the limited supply of sugar and starch by-products, animal fats and used cooking oil feedstocks. For biofuels to contribute significantly to transport fuel consumption,

a large proportion of arable land would have to be devoted to energy crops production. In 2005, the European Union (EU) used 3 per cent of its total arable land for biofuel feedstocks producing 4.9 billion litres of biofuels, which represented around 1 per cent of liquid fuels consumption in the EU transport sector (European Commission 2007; IEA 2007b).

First generation biofuels from energy crops require sustainable agricultural practices to minimise environment impacts, the adoption of crop rotation with an energy crop diversifies the crops grown, which can improve the land for traditional cropping and provide a high value crop (FAO 2008). In Australia, biofuel production is currently too low to affect the production of agricultural commodities.

Second generation biofuels will be produced from specialised energy crops, such as tree crops and algae, as well as from residue and the waste streams. The utilisation of residue and waste material for biofuels requires no additional land. Second generation biofuel feedstocks may also be grown on less productive lands and degraded agricultural land that do not compete directly with growing food, stockfeed and fibre crops (IEA Bioenergy 2008). Some second generation feedstocks, such as algae and oil mallee, do not compete for freshwater resources.

Worldwide, investment in second generation technologies is being undertaken to ensure these characteristics – environmental and economic viability and avoidance of competition for productive land with food and fibre production – are achievable and therefore that the future production of bioenergy can proceed in a sustainable way.

### **12.4.2 Outlook for bioenergy resources**

The bioenergy supply chain is complex because of its interaction with other supply chains such as agricultural and forestry. There is scope to optimise current production systems for the bioenergy market without diverting biomass from current uses (e.g. plantation thinnings). The production of second generation feedstocks on less productive or under-utilised lands could potentially provide economic, environmental and social benefits (O'Connell et al. 2009a). The use of such land may provide opportunities for: farmers to diversify existing systems; the development of industries in rural regions; and improvements in biodiversity. Currently, second generation biofuels are not commercially competitive in any country. The transition from first to second generation technologies will require significant R&D investment which, in turn, will only be attracted by an industry with a significant and sustainable future. The industry needs to demonstrate that the potential it offers meets these criteria.

**Table 12.11** Potential for stationary bioenergy generation in Australia

Biomass	Quantity	Conversion technologies	Electricity generation GWh/yr		
	2005–06		2010	2020	2050
<b>Agricultural related wastes</b>					
Poultry	94 384 000 population	AD/RGE	-	90	848
		P	-	207	207
Cattle (feedlots)	870 025 population	AD/RGE; DC/ST	-	112	442
Pigs	1 801 800 population	AD/RGE	1	22	205
Dairy cows	1 394 000 population	AD/RGE	-	22	89
Abattoirs	1 285 000 t	AD/RGE		337	1773
Nut shells	-	DC/ T	1		1
Stubble residues from grain and cotton crops	24 000 000 t	DC/ST; G/GT; P			47 000
Bagasse (sugar cane residue)	5 000 000 t	DC/ST	1200	3000	4600
Sugar cane trash, tops and leaves	4 000 000 t	DC/ST	-	165	3200
<b>Energy crops</b>					
Algae	-	AD/RGE; P		-	-
Oil mallee	-	DC/ST; G/GT; P		112	484
<b>Woody weeds</b>					
Camphor laurel	-	DC/ST; G/GT; P		83	20
<b>Forest residues</b>					
Native forest (public and private)	2 200 000 t	AD/RGE; DC/ST; briquetting and pelletising; G/GT; charcoal production; Co-firing	79	2442	4554
Plantation (public and private)	3 800 000 t				
Sawmill and wood chip residues	2 800 000 t				
<b>Pulp and paper mills wastes</b>					
Black liquor	-	DC/ST	285	365	365
Wood waste	-	DC/ST	60	85	85
Recycled paper wet wastes	-	AD/RGE	2	8	8
Paper recycling wastes	-	DC/ST	12	48	48
<b>Urban waste</b>					
Food and other organics	2 890 000 t	AD/RGE	13	126	565
		DC/ST	16	141	189
Garden organics	2 250 000 t	P	-	37	186
		AD/RGE	29	84	275
Paper and cardboard	2 310 000 t	DC/ST	-	-	1548
		P	-	38	191
Wood/timber	1 630 000 t	DC/ST	45	295	1366
Landfill gas	9 460 000 t	Spark ignition engine; co-firing; flaring	772	1880	3420
Sewage gas	735 454 t	AD/RGE; DC/ST	57	901	929

AD = anaerobic digestion; RGE = reciprocating gas engine; P = pyrolysis; DC = direct combustion; ST = steam turbine; G = gasification; GT = gas turbine

Source: Clean Energy Council 2008

## Electricity and heat generation

Currently electricity is generated predominantly from bagasse and landfill and sewage sites and to a lesser degree wood waste, pulp and paper mill waste. The Clean Energy Council (2008) identified significant potential for growth in bioenergy production from waste streams, such as landfill and sewage gas and urban waste.

An appraisal of bioenergy resources, primarily waste streams, for stationary energy was undertaken by the Clean Energy Council in 2008 to estimate the potential by 2020 and in the long-term (2050). The assessment is based on biomass quantities potentially available in 2005–06. The biomass feedstocks are grouped into agricultural related wastes, energy crops, woody weeds, forest residues, pulp and paper mill wastes, and urban wastes (table 12.11).

**Agricultural related wastes** in total are a very large resource but currently are not used as feedstocks. The resources are widely dispersed and can have a range of alternative uses including composting and feed for animals.

The sugar cane industry, already one of the few industries self sufficient in energy through its use of bagasse-fired cogeneration, has the potential to increase electricity generation efficiency with integrated gasification combined cycle technology as well as biomass expansion to include sugar cane trash, tops and leaves.

Crop residues from grain and cotton crops are a potential resource. However, crops can be subject to large annual variations of quantities produced due to environmental and climatic factors. An option to reduce the variability of resources is to process a wide range of biomass material such as residues from grain, rice, cotton crops and left-over plant matter from vegetables and fruits.

The potential estimated stubble residues that can be collected, taking into account that a proportion of the crop is left on the land for maintenance of soil health, is estimated to be 24 Mt per year. However, the high cost of transport of a highly dispersed resource means that there will be little or no contribution from this sector to 2020. For this sector to contribute to energy production there needs to be further investigation of energy conversion processes (e.g. gasification and pyrolysis) and ways to reduce transport costs. A long-term estimate of potential energy is 47 000 GWh per year (Clean Energy Council 2008).

Large scale livestock feedlots, piggeries, dairy and poultry farms with their mixed waste streams of animal bedding and manure are suitable for generating bioenergy. Waste material can be used to produce stationary energy and assist in reducing

environmental problems from waste disposal, methane emissions and pollution of water supplies.

The Clean Energy Council estimated that the long-term potential for feedlot cattle and piggeries are about 440 GWh per year and 200 GWh per year, respectively. However, there are uncertainties with moisture content and suitability for combustion or anaerobic digestion. Poultry farm waste is estimated to have a long-term potential in the range of 840 GWh per year. This estimate does not take into account that some operations may be too small to be viable or that poultry manure is used for fertiliser.

In addition, there is also the potential of solid wastes from abattoirs. The Clean Energy Council indicated that there are approximately 0.77 Mt to 1.8 Mt per year of solid waste produced from about 150 abattoirs. If by 2020, 30 abattoirs implement anaerobic digestion cogeneration plants, these projects have the potential to produce about 340 GWh per year, with a long-term estimate of about 1770 GWh per year.

Native forest **wood waste** is assumed to remain relatively constant: however the potential from plantation wood waste should increase in line with plantation expansion. Australian governments, at all levels, have established regulatory mechanisms concerning the eligibility for forest wood waste for electricity generation in order to manage the sustainable use of these products.

**Urban waste**, including food, garden, urban timber, paper and cardboard wastes, is steadily growing and has significant potential for energy generation. The decomposition of these wastes in landfill results in methane generation, which is not appropriately captured and utilised, particularly in older and smaller landfill sites. In 2002–03 approximately 9.5 Mt per year of organic urban waste was sent to landfill. The potential electricity generation for 9 Mt of urban waste is 103 GWh, with a long-term estimate of about 4300 GWh (Clean Energy Council 2008).

There is potential for growth of biogas power generation from landfill sites and sewage treatment plants in urban and rural centres for local use. Converting biogas to energy would provide dual benefits of energy supply and reduced greenhouse gas emissions. If these wastes are not collected and used for bioenergy production, the gas would be flared or vented into the atmosphere.

There is a number of potential **energy crops** that may provide fuel for future bioenergy as well as providing environmental benefits. The integration of complementary energy crops and woody perennials into existing agricultural systems may be able to reduce dryland salinity and land erosion.

The Oil Mallee project in Western Australia

**Table 12.12** Estimated energy and fuel yields for different feedstocks

Feedstock	Ethanol L/t	Biodiesel L/t	Synfuel* L/t	Electricity MWh/t
<b>First Generation</b>				
Cereals	360			
Oilseeds		400		
Sugar cane				
Molasses	280			
Sugar	560			
<b>Second Generation</b>				
Cereals	335		246	1.02
Wood waste	240		246	1.35
Algae		495		0.27
Sugar cane				
Whole plant	465		246	0.80
Bagasse	300		246	0.80
Forestry				
Sawmill residues	233		246	1.35
Harvest residues	233		246	1.35
Pulpwood	240		246	1.35
Bioenergy plantations	260		246	1.35
Grasses	323		246	1.02

\*Production using gasification, gas condition and cleaning followed by Fischer Tropsch synthesis and refining to produce syngasoline and syndiesel

Source: O'Connell et al. 2009b

successfully demonstrated the use of Mallee eucalypts to produce eucalyptus oil, activated carbon and generate electricity. Woody weeds, such as Camphor Laurel, are abundant but either need research into their suitability as feedstock, or are too dispersed in nature to be economical to harvest.

R&D into algae is drawing attention because of its potential high hydrocarbon content, high oil yields and ability to be grown in saline and waste water. Algae grown and harvested from purpose-built ponds and photobioreactors has the potential to be a feedstock for biofuels and power generation.

### Transport biofuels

First generation biofuels are not expected to make a large contribution to Australia's future biofuels supply as there is limited availability of low cost first generation feedstocks. Second generation technologies may provide a greater range of biomass feedstocks and potential greenhouse gas emissions savings. Second generation technologies will use lignocellulosic material, specialised crops such as oil mallee, non-food components of crops and algae.

O'Connell et al. (2009b) estimated yields of biofuels and electricity generation from different feedstock for the first and second generation technologies (table 12.12). The analysis was restricted to Queensland and did not provide spatially explicit analysis of biofuel feedstock production. However, it does provide useful 'first cut' estimates of the

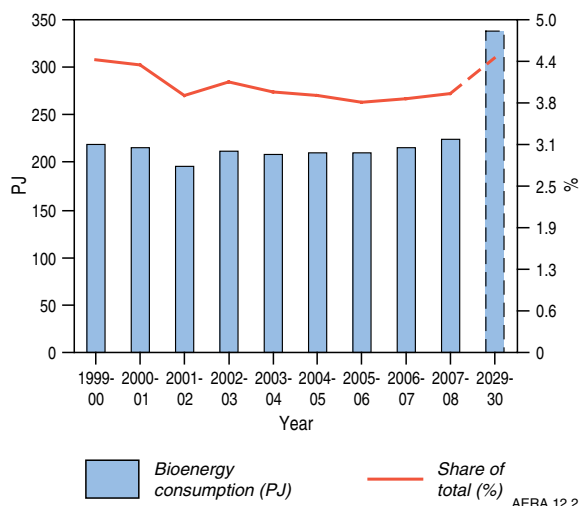
possibilities. Current technologies can produce 280 to 560 litres of ethanol per tonne of biomass and 400 litres of biodiesel per tonne of oilseeds. The second generation technologies will use a wider range of biomass feedstocks to produce ethanol, biodiesel, synfuel and generate electricity. That report estimated that approximately 55 Mt of stubble residue biomass per year can be produced based on 20 per cent of the current 45 million hectares of grazing and cropping land, and that there is potentially about 6 tonnes of biomass per hectare per year. This biomass resource could produce approximately 82 TWh per year of electricity or 17 GL per year of syngasoline and syndiesel.

### 12.4.3 Outlook for bioenergy market

Bioenergy has the potential to make a growing contribution to Australia's energy use, and to electricity generation in particular. Australia's current bioenergy production is principally sourced from by-products of production processes or waste products. There are still under-utilised waste products that may be used for bioenergy in the future.

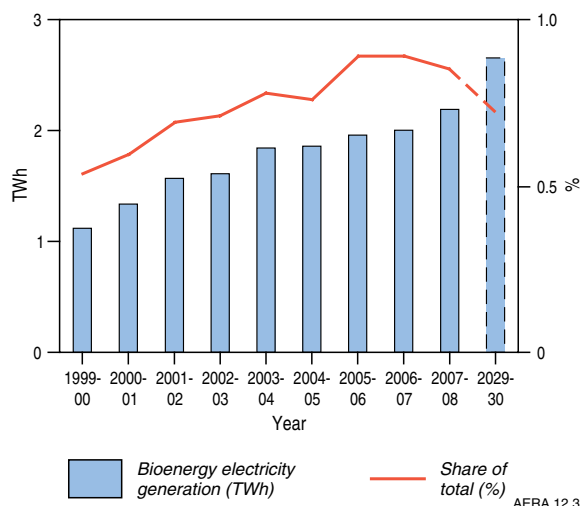
In ABARE's latest energy projections, which include the Renewable Energy Target, a 5 per cent emissions reduction target, and other government policies, bioenergy use in Australia is projected to increase by 60 per cent to 340 PJ in 2029–30, representing an average annual growth rate of 2.2 per cent (figure 12.15).





**Figure 12.15** Projected primary consumption of bioenergy

Source: ABARE 2009a; ABARE 2010



**Figure 12.16** Projected electricity generation from bioenergy

Source: ABARE; ABARE 2010

Australia's large potential bioenergy resources, the Renewable Energy Target and the potential commercialisation of second generation technologies are all expected to drive an increase in electricity generation from bioenergy. However, growth is likely to be constrained to some extent by competition for land and water resources and logistical issues associated with handling, transport and storage. Some second generation feedstocks such as algae and solid biomass wastes may substantially reduce the problems associated with land use and water resources.

Electricity generation from bioenergy (excluding cogeneration) is projected to increase at an average rate of 2.3 per cent per year from 2 TWh in 2007–08 to 3 TWh by 2029–30 (figure 12.16). More than 60 per cent of the projected growth in the use of bioenergy for electricity generation is projected to occur in Queensland.

### Bioenergy project developments

As at October 2009, there were three projects under development in Australia (table 12.14). In Tasmania, Gunns Ltd plans to develop a large cogeneration power plant of 200 MW capacity at its Bell Bay pulp mill. WA Biomass Pty Ltd plans to construct and operate a 40 MW power plant fuelled by up to 380 000 tonnes per year of plantation waste in Western Australia. National Biodiesel Ltd plans to construct a soybean processing and biodiesel production facility at Port Kembla, New South Wales. The facility will process over a million tonnes of soybean per year into high quality soybiodiesel®, soybean meal (animal feed) and pharmaceutical grade vegetable glycerine.

In addition, there is a number of R&D projects investigating bioenergy technologies and biomass potential across Australia.

### Electricity and heat generation

There are several proposed bioenergy power plants using a range of biomass feedstocks, such as animal, municipal and sawmill and pulp mill wood wastes and forestry and plantations residues. There are research projects on methane capture systems from uncovered effluent treatment lagoons and energy generation from intensive animal industries such as dairy farms, beef cattle feedlots and piggeries.

In Victoria, there is a proposal to use fire-affected tree residues from bushfire-affected areas. TreePower Australia has undertaken a feasibility study for a 1 MW biomass fired Organic Rankine Cycle cogeneration power plant near Marysville, Victoria. The company is considering a trigeneration option, in which some (or all) of the heat output would drive an absorption chiller process for cooling outputs.

### Transport biofuels

In August 2009, the Australian Government announced A\$15 million funding for projects under the Second Generation Biofuels Research and Development Program to demonstrate the sustainable development of the biofuels industry. The projects include researching biofuel from microalgae, developing a pilot-scale biorefinery for sustainable microalgal biofuels and value added products, investigating the production of biofuels from mallee biomass by pyrolysis, developing a sugar cane biomass input system for biofuel production and commercial demonstration of lignocellulosics to stable bio-oil.

Rural Industries Research and Development Corporation (RIRDC) has a Bioenergy, Bioproducts and Energy program to conduct research into

**Table 12.14** Bioenergy development projects, as at October 2009

Project	Company	Location	Status	Start up	Capacity	Capital expenditure A\$million
Bell Bay Power Plant	Gunns Ltd	North of Launceston, Tas	On hold due to uncertainty of pulp mill construction	NA	200 MW	NA
WA Biomass Power Plant	WA Biomass Pty Ltd	Manjimup, south west WA	Feasibility study under way	NA	40 MW	110
Soybean Processing and Biodiesel Production Facility	National Biodiesel Ltd	Port Kembla, NSW	Development approval	NA	Soybiodiesel@ 288 ML per year	240

**Note:** Only includes power generation projects for which generation capacity is proposed to exceed 30 MW

**Source:** ABARE 2009b

and develop sustainable and profitable bioenergy and bioproducts industries. Research has been completed on identifying and developing Australian native species as biofuel crops and research is in progress in evaluating biodiesel potential of Australian native plants, Indian mustard seed and biofuel production of giant reed grass. RIRDC is compiling a detailed listing of projects currently underway in Australia.

The National Collaborative Research Infrastructure Strategy (NCRIS), an Australian and State government partnership is enhancing Australia's capacity to produce biofuels derived from non-food biomass. NCRIS involves the development of five integrated sites to provide researchers with access to quality facilities, technologically advanced equipment, and technical expertise. Macquarie University, University of Sydney and University of New South Wales are providing access to facilities for the conversion of lignocellulosic and microalgae biomass to biofuels (ethanol and biodiesel). Two pilot-scale manufacturing facilities are also being established:

- a biomass biorefinery at Queensland University of Technology, for the conversion of lignocellulosic biomass to ethanol, lignin and other commodities and;
- a photobioreactor facility at South Australian Research and Development Institute for the demonstration of microalgae biomass culture for biodiesel production.

The Biofuels Cooperative Research Centre, an initiative of the BioEnergy Research Institute at Southern Cross University is researching non-food crops that will grow with a reduced reliance on water, such as Australian native species, which have the advantage of adaptable for marginal growing areas.

## 12.5 References

ABARE (Australian Bureau of Agricultural and Resource Economics), 2009a, Australian energy statistics, Canberra, August

ABARE, 2009b, Electricity generation major development projects — October 2009 listing, Canberra, November

ABARE, 2010, Australian energy projections to 2029–30, ABARE research report 10.02, prepared for the Department of Resources, Energy and Tourism, Canberra

Batten D and O'Connell D, 2007, Biofuels in Australia: Some economic and policy considerations, RIRDC Publication No07/177, Rural Industries Research and Development Corporation and CSIRO, Canberra

Clean Energy Council, 2008, Australian bioenergy road map and biomass resource appraisal, <<http://cleanenergycouncil.org.au/bioenergy/>>

CSIRO, 2009, Natural Research Flagships Energy Transformed, <<http://www.csiro.au/org/EnergyTransformedFlagship.html>>

EESI (Environmental and Energy Study Institute), 2009a, Issue brief: Biomass co-firing: A transition to a low carbon future, March

EESI, 2009b, Issue Brief: Reconsidering municipal solid waste as a renewable energy feedstock, July

European Commission, 2007, Biofuels in the European Union: An agricultural perspective, European Commission Directorate-General for Agriculture and Rural Development, Brussels

FAO (Food and Agriculture Organization of the United Nations), 2008, Biofuels: prospects, risks and opportunities, The State of Food and Agriculture, Rome

Geoscience Australia, 2009, Renewable Energy Generators in Australia, on behalf of Department of Environment, Water, Heritage and the Arts <<http://www.ga.gov.au/renewable>>

Grabowski P, 2004, Biomass co-firing: A presentation to the Department of Energy and United States Department of Agriculture Technical Advisory Committee, 11 March

Hoogwijk M, 2006, Global biomass availability: Assumption and conditions, IEA Bioenergy ExCo58, 4 October

IEA (International Energy Agency), 2006a, Energy technology perspectives 2006, OECD/IEA, Paris

IEA, 2006b, Renewable energy: R&D priorities insights from IEA technology programmes 2006, OECD/IEA, Paris

IEA, 2007a, IEA energy technology essentials: Biomass for power generation and CHP, OECD/IEA, Paris, January

IEA, 2007b, IEA energy technology essentials: Biofuels production, OECD/IEA, Paris, January

IEA, 2008, Energy technology perspectives 2008, OECD/IEA, Paris

IEA, 2009a, World energy balances 2009, OECD/IEA, Paris

IEA, 2009b, World energy outlook 2009, OECD/IEA, Paris

IEA Bioenergy, 2007, Potential contribution of bioenergy to the world's future energy demand, OECD/IEA, Paris

IEA Bioenergy, 2008, From 1st to 2nd generation biofuel technologies: An overview of current industry and RD&D activities, OECD/IEA, Paris, November

IEA Bioenergy, 2009a, Bioenergy – a sustainable and reliable energy source: A review of status and prospects, OECD/IEA, Paris

IEA Bioenergy, 2009b, Bioenergy – a sustainable and reliable energy source: Main report, OECD/IEA, Paris, December

Massachusetts Technology Collaborative, 2009, Bioenergy technologies, <<http://www.masstech.org/cleanenergy/biomass/technology.htm>>

National Renewable Energy Laboratory, 2009, Biomass research: What is a biorefinery? <<http://www.nrel.gov/biomass/biorefinery.html>>

O'Connell D, Braid A, Raison J, Handberg K, Cowie A, Rodriguez L and George B, 2009a, Sustainable production of bioenergy; A review of global bioenergy sustainability frameworks and assessment systems, RIRDC Publication No09/167, Rural Industries Research and Development Corporation and CSIRO, Canberra, November

O'Connell D, May B, Farine D, Raison J, Herr A, O'Connor M, Campbell PK, Taylor J, Dunlop M, Poole M and Crawford D, 2009b, Substitution of fossil fuels with production of biofuel and bioenergy from renewable resources; In Eady S, Battaglia M, Grundy M, and Keating B, (eds), An analysis

of greenhouse gas mitigation and carbon biosequestration opportunities from rural land use, Report to the Queensland state government, June, <<http://www.csiro.au/resources/carbon-and-rural-land-use-report.html>>

O'Connell D, Batten D, O'Connor M, May B, Raison J, Keating B, Beer T, Braid A, Haritos V, Begley C, Poole M, Poulton P, Graham S, Dunlop M, Grant T, Campbell P and Lamb D, 2007, Biofuels in Australia – an overview of issues and prospects, Rural Industries Research and Development Corporation and CSIRO, Canberra

Oil Mallee Association, 2009, The oil mallee project, Narrogin bioenergy plant, accessed December 2009, <<http://oilmallee.org.au/index.html>>

REN21, 2009, Renewables Global Status Report: 2009 Update, Paris <[http://www.ren21.net/pdf/RE\\_GSR\\_2009\\_Update.pdf](http://www.ren21.net/pdf/RE_GSR_2009_Update.pdf)>

Saddler H, Diesendorf M and Denniss R, 2004, A clean energy future for Australia, Energy Strategies for the Clean Energy Future Group, <<http://www.enerstrat.com.au>>

Stuckey CR, Schuck SM, Sims RE, Larsen PL, Turvey ND and Marine BE, 2004, Biomass energy production in Australia: Status, costs and opportunities for major technologies, RIRDC Publication No04/031, Rural Industries Research and Development Corporation, Bioenergy Australia, Canberra

The University of Tennessee, 2009, Office of Bioenergy Programs, Biorefinery groundbreaking, accessed December 2009, <<http://www.utbioenergy.org/TNBiofuelsInitiative/Biorefinery+Groundbreaking.htm>>

Warden AC and Haritos VS, 2008, Future biofuels for Australia: Issues and opportunities for conversion of second generation lignocellulosics, RIRDC Publication No8/117, Rural Industries Research and Development Corporation, Canberra

Wild A, 2009, Biofuels and competition in Australia, CSIRO, accessed October 2009, <<http://www.csiro.au/science/biofuels-and-competition.html>>

Worldwatch Institute, 2006, Biofuels for transportation: Global potential and implications for energy and agriculture in the 21st Century, <<http://www.worldwatch.org/publs/biofuels>>

# Appendices



## Appendix A: Australian Energy Resource Assessment Terms of Reference

A comprehensive and integrated assessment of Australia's energy resources will be developed to support industry investment decision-making and government policy development. The Department of Resources, Energy and Tourism has jointly commissioned Geoscience Australia and the Australian Bureau of Agricultural and Resource Economics to undertake the assessment.

The assessment will:

- 1) Provide a comprehensive and integrated compilation and assessment of energy resources within Australia's economic zones to inform future industry investment analysis and decision making and government policy development. This information will relate to the exploration, development and delivery of energy resources to export points and to users within the domestic energy market.
- 2) Incorporate spatial, statistical, explanatory and, where appropriate, interpretive assessments (past, present and projected) covering:
  - a) energy resources, including conventional oil, gas (natural and coal seam methane), coal and uranium resources; renewable resources (wind, solar, hydro and biomass); emerging resources, including geothermal, and non-conventional resources requiring further development (oil shale, tight gas sands, hydrate resources, deep coals (underground gasification), marine energy (renewable wave and tidal power) and thorium
  - b) economic information from exploration, development, production, to use (export and domestic)
  - c) infrastructure, from exploration, development and delivery to market of energy.
- 3) Incorporate (where available) related general information, including:
  - a) human professional, technical and related resources of the energy resources sector
  - b) social information (from the Australian Bureau of Statistics).
- 4) Deliver:
  - a) a common lexicon of energy resources and economic definitions
  - b) a comprehensive outline (content and sources) of the full assessment by June 2009, including initial analyses to inform the Energy Green Paper; the assessment, and in particular the resources component, is to be linked to existing resource information systems and internet-based mapping systems
  - c) a report on future information requirements to support Australian energy resources exploration and development to 2030, by September 2009
  - d) a completed Australian Energy Resources Assessment to be published as a companion document to the Energy White Paper in December 2009.

## Appendix B: Abbreviations and Acronyms

<b>ABARE</b>	Australian Bureau of Agricultural and Resource Economics	<b>JORC</b>	Joint Ore Reserves Committee
<b>ABS</b>	Australian Bureau of Statistics	<b>LCOE</b>	Levelised cost of electricity
<b>AEMC</b>	Australian Energy Market Commission	<b>LNG</b>	Liquefied natural gas
<b>APEC</b>	Asia Pacific Economic Cooperation	<b>LPG</b>	Liquefied petroleum gas
<b>APERC</b>	Asia Pacific Energy Research Centre	<b>MRET</b>	Mandatory Renewable Energy Target
<b>APPEA</b>	Australian Petroleum Production and Exploration Association	<b>NEM</b>	National Electricity Market
<b>ASX</b>	Australian Securities Exchange	<b>OECD</b>	Organisation for Economic Co-operation and Development
<b>BOM</b>	Bureau of Meteorology (Australian Government)	<b>OPEC</b>	Organisation of Petroleum Exporting Countries
<b>CCS</b>	Carbon (dioxide) capture and storage	<b>R&amp;D</b>	Research and development
<b>COAG</b>	Council of Australian Governments	<b>RD&amp;D</b>	Research, development and demonstration
<b>CPRS</b>	Carbon Pollution Reduction Scheme	<b>RET</b>	Department of Resources, Energy and Tourism (Australian Government)
<b>CSG</b>	Coal seam gas	<b>RET</b>	Renewable Energy Target
<b>CSIRO</b>	Commonwealth Scientific and Industrial Research Organisation	<b>SDR</b>	Sub-economic demonstrated resources
<b>DCC</b>	Department of Climate Change (Australian Government)	<b>USGS</b>	United States Geological Survey
<b>DEWHA</b>	Department of the Environment, Water, Heritage and the Arts (Australian Government)	<b>WEC</b>	World Energy Council
<b>EDR</b>	Economic demonstrated resources	<b>Units</b>	
<b>EIS</b>	Environmental impact statement	<b>GJ</b>	Gigajoule – $10^9$ joules
<b>EPA</b>	Environment Protection Agency	<b>Gt</b>	Gigatonne – $10^9$ tonnes
<b>EPBC</b>	Environmental Protection and Biodiversity Conservation Act 1999 (Commonwealth of Australia)	<b>GW</b>	Gigawatt – $10^9$ watts
<b>EPRI</b>	Electric Power Research Institute (of USA)	<b>kt</b>	Kilotonne – thousand ( $10^3$ ) tonnes
<b>ETS</b>	Emissions Trading Scheme	<b>kW</b>	Kilowatt – thousand ( $10^3$ ) watts
<b>GA</b>	Geoscience Australia	<b>kWh</b>	Kilowatt-hours – thousand ( $10^3$ ) watt-hours
<b>GHG</b>	Greenhouse gas (emissions)	<b>ML</b>	Megalitre – million ( $10^6$ ) litres
<b>GSHP</b>	Ground source heat pump	<b>mmbbl</b>	Million ( $10^6$ ) barrels
<b>IEA</b>	International Energy Agency	<b>Mt</b>	Million ( $10^6$ ) tonnes
<b>IGCC</b>	Integrated gasification combined cycle (electricity generation technology)	<b>MW</b>	Megawatts – $10^6$ watts
<b>INF</b>	Inferred resources	<b>MWh</b>	Megawatt-hours – $10^6$ watt-hours
		<b>PJ</b>	Petajoules – $10^{15}$ joules
		<b>tcf</b>	Trillion ( $10^{12}$ ) cubic feet
		<b>TJ</b>	Terajoules – $10^{12}$ joules
		<b>TWh</b>	Terawatt-hours – $10^{12}$ watt-hours



## Appendix C: Glossary

### Accumulation (petroleum)

An individual body of naturally occurring petroleum in a reservoir or a group of reservoirs that are related to a localised geological structural feature and/or stratigraphic condition (trap).

### Availability factor

Percentage of time that an electricity generating plant can be operated at full output.

### Base load

The minimum level of demand (load) on an electricity supply system that exists 24 hours a day.

### Biofuels

Liquid fuels (e.g. ethanol, biodiesel) produced directly or indirectly from biomass.

### Biogas

Gas captured from landfill sites (garbage tips), sewage treatment plants and livestock feedlots.

### Biomass

Vegetable and animal derived organic materials, such as forestry residues, wood waste, bagasse (sugar cane residue), oilseed crops and animal waste.

### Basin

A geological depression filled with sedimentary rocks.

### Capacity factor

The amount of electricity that the plant produces over a given period divided by the amount of electricity it could have produced if it had run at full power over that same period.

### Cogeneration

Also known as a CHP (combined heat and power). Simultaneous production of heat and electricity in the one fuel combustion process.

### Completion (petroleum)

The process by which a finished well (borehole) is either sealed off or prepared for production.

### Conventional resources (petroleum)

Petroleum resources within discrete accumulations that are recoverable through wells (boreholes) and typically require minimal processing prior to sale. For natural gas, the term generally refers to methane held in a porous rock reservoir frequently in combination with heavier hydrocarbons.

### Conversion

The process of transforming one form of energy into another before use. Conversion itself consumes energy, calculated as the difference between the energy content of the fuels consumed and that of the fuels produced.

### Development

Petroleum: phase in which a proven oil or gas field is brought into production by drilling production wells.

Minerals: phase in which the mineral deposit is brought into production through development of a mine.

### Discovered petroleum initially-in-place

Quantity of petroleum that is estimated, as of a given date, to be contained in known accumulations prior to production.

### Discovery

Petroleum: first well (borehole), in a new field from which any measurable amount of oil or gas has been recovered. A well that makes a discovery is classified as a new field discovery (NFD).

Minerals: first drill intersection of economic grade mineralisation at a new site.

### Enhanced oil recovery

The extraction of additional petroleum, beyond primary recovery, from naturally occurring reservoirs by supplementing the natural forces in the reservoir. It includes water flooding and gas injection for pressure maintenance (secondary processes) and any other means of supplementing natural reservoir recovery processes, including thermal and chemical processes to improve the in-situ mobility of viscous forms of petroleum (tertiary processes).

### Exploration

Phase in which a company or organisation searches for petroleum or mineral resources by carrying out detailed geological and geophysical surveys, followed up where appropriate by drilling and other evaluation of the most prospective sites.

### Extension/appraisal wells (petroleum)

Wells (boreholes) drilled to determine the physical extent, reserves and likely production rate of a field.

### Field (petroleum)

An area consisting of a single reservoir or multiple reservoirs grouped on, or related to, the same individual geological structural feature and/or stratigraphic condition.

### Fossil fuels

A hydrocarbon deposit in geological formations that may be used as fuel such as crude oil, coal or natural gas.

### Gas-to-liquids

Technologies that use specialised processing (e.g. Fischer-Tropsch synthesis) to convert natural gas into liquid petroleum products.

### JORC Code

The Australasian Code for Reporting of Exploration Results, Mineral Resources and Ore Reserves, prepared by the Joint Ore Reserves Committee.

It is a principles-based code which sets out recommended minimum standards and guidelines on classification and public reporting in Australasia. Companies listed on the Australian Securities Exchange are required to report exploration outcomes, resources and reserves in accordance with the JORC Code standards and guidelines.

**Liquid fuels**

All liquid hydrocarbons, including crude oil, condensate, LPG, and other refined petroleum products.

**Load factor**

The ratio of the actual amount of kilowatt-hours delivered on a system in a given period of time to the total possible kilowatt-hours that could be delivered on the system over that same time period.

**Megawatt, gigawatt, terawatt**

$10^6$ ,  $10^9$ ,  $10^{12}$  watts respectively. Measures of electricity generator capacity or output. Consumption is measured in multiples of watt-hours. See also Appendix E.

**Non-renewable resources**

Resources, such as fossil fuels (crude oil, natural gas, coal) and uranium that are depleted by extraction.

**Peak load**

Period of most frequent or heaviest use of electricity.

**Petajoule**

$10^{15}$  joules, the standard form of reporting energy aggregates. One petajoule is equivalent to 278 gigawatt-hours. See also Appendix E.

**Play (geological)**

A model that can be used to direct petroleum exploration. It is a group of fields or prospects in the same region and controlled by the same set of geological circumstances.

**Primary energy**

Energy found in nature that has not been subjected to any conversion or transformation process.

**Primary fuels**

The forms of energy sources obtained directly from nature. They include non-renewable fuels such as black coal, brown coal, uranium, crude oil and condensate, natural gas, and renewable fuels such as biomass, hydro, wind, solar, ocean and geothermal.

**Primary recovery**

The extraction of petroleum from reservoirs utilising the natural energy available in the reservoirs to move fluids through the reservoir rock to points of recovery.

**Production**

Petroleum: the phase of bringing well fluids to the surface, separating them and storing, gauging and otherwise preparing them for transport.

Minerals: the phase at which operations produce mined product.

**Prospect (geological)**

A potential accumulation of petroleum or minerals that is sufficiently well defined to represent a viable drilling target.

**Renewable resources**

Resources that can be replenished at a rate equal to or greater than the rate of depletion, such as biomass, hydro, solar, wind, ocean and geothermal.

**Resources**

A concentration of naturally occurring solid, liquid or gaseous materials in or on the Earth's crust in such form and amount that its economic exploitation is currently or potentially feasible. See also Appendix D.

**Total final energy consumption**

The total amount of energy consumed in the final or end-use sectors. It is equal to total primary energy consumption less the energy consumed or lost in conversion, transmission and distribution.

**Total primary energy consumption**

Also referred to as total domestic availability. The total of the consumption of each primary fuel (in energy units) in both the conversion and end-use sectors. It includes the use of primary fuels in conversion activities – notably the consumption of fuels used to produce petroleum products and electricity. It also includes own-use and losses in the conversion sector.

**Trap (geological)**

Any barrier to the upward movement of oil or gas, allowing either or both to accumulate. The barrier can be a stratigraphic trap, an overlying impermeable rock formation or a structural trap as result of faulting or folding.

**Unconventional resources (petroleum)**

Resources within petroleum accumulations that are pervasive throughout a large area and that are not significantly affected by hydrodynamic influences. Typically, such accumulations require specialised extraction technology. Examples include coal seam gas (CSG), tight gas, shale gas, gas hydrates, natural bitumen and shale oil.

**Undiscovered accumulation (petroleum)**

Generally, all undiscovered petroleum deposits irrespective of their economic potential. All of the petroleum accumulations that may occur in multiple reservoirs within the same structural or stratigraphic trap are referred to as undiscovered fields.

**Wildcat well**

A petroleum exploration well drilled on a structural or stratigraphic trap that has not previously been shown to contain petroleum.

## Appendix D: Resource Classification

Development of new energy sources requires reliable estimates of how much energy is available at potential development sites. The estimation and classification of energy resources varies according to type.

### Mineral and petroleum resource classification

The non-renewable energy resources are geologically-based and their classification is largely based on the McKelvey resource classification system.

The McKelvey resource classification system classifies known (identified) resources according to the certainty or degree of (geological) assurance of occurrence and the degree of economic feasibility of exploitation either now or in the future. The first takes account of information on the size and quality of the resource, whereas the economic feasibility considers the changing economic factors such as commodity prices, operating costs, capital costs, and discount rates.

The assessments of **identified resources** – resources for which the location, quantity, and quality are known from specific measurements or estimates from geological evidence – are based on and compiled from resource data reported for individual mineral deposits and petroleum and gas accumulations

by companies but take a long term (20–25 year) view of the feasibility for economic extraction. The Australian Securities Exchange mandates standards for the public reporting of mineral and petroleum resources by Australian-listed companies. Oil and gas companies are required to follow the Petroleum Resources Management System of the Society of Petroleum Engineers in reporting petroleum resources or define the alternative standard used. Listed companies must follow the Joint Ore Reserves Committee (JORC) Code for the public reporting of ore reserves and mineral resources under their control.

Data from company reports on specific projects are aggregated into categories in the national classification scheme to provide estimate of the national resource base.

In the national system used by Geoscience Australia (figure D.1), **Demonstrated resources** are resources that can be recovered from an identified resource and whose existence and quality have been established with a high degree of geological certainty, based on drilling, analysis, and other geological data and projections.

**Economic demonstrated resources** (EDR) are resources with the highest levels of geological and economic certainty. For petroleum these include

		DECREASING GEOLOGICAL ASSURANCE →		
DECREASING ECONOMIC FEASIBILITY ↓	<b>Identified resources</b>		<i>Undiscovered resources</i>	
	<b>Demonstrated resources</b>		<b>Inferred resources</b>	
	<b>Economic Demonstrated Resources</b>	JORC mineral reserves Proved petroleum reserves	JORC inferred mineral resources	
		Proved and probable petroleum reserves JORC measured and indicated mineral resources	Possible petroleum resources	
<b>Subeconomic Resources</b>	Subeconomic mineral resources Contingent proved and probable petroleum resources	Contingent possible petroleum resources		
		Quantitative mineral potential assessments Undiscovered petroleum resource assessments		

AERA D.1

**Figure D.1** Australia's national energy resources classification scheme (based on the McKelvey resource classification scheme). See text for explanation of terms

**Source:** Geoscience Australia

remaining proved plus probable commercial reserves. For minerals, these include JORC Code proved and probable ore reserves and measured and indicated mineral resources. For these categories, profitable extraction or production has been established, analytically demonstrated or assumed with reasonable certainty using defined investment assumptions.

**Sub-economic demonstrated resources** (SDR) are resources for which, at the time of determination, profitable extraction or production under defined investment assumptions has not been established, analytically demonstrated, or cannot be assumed with reasonable certainty (this includes contingent petroleum resources).

**Inferred resources** (INF) are those with a lower level of confidence that have been inferred from more limited geological evidence and assumed but not verified. Where probabilistic methods are used there should be at least a 10 per cent probability that recovered quantities will equal or exceed the sum of proved, probable and possible reserves.

**Undiscovered or potential resources** are unspecified resources that may exist based on certain geological assumptions and models, and be discovered through future exploration. Undiscovered resource assessments have inbuilt uncertainties, and are dynamic and change as knowledge improves and uncertainties are resolved.

**Uranium resources** at the national level are commonly reported under the Nuclear Energy

Agency/International Atomic Energy Agency (IAEA) uranium resources classification system. Economic Demonstrated Resources correlate with **Reasonably Assured Resources** recoverable at <US\$80/kg U, and **Inferred Resources** are the same in both systems. Coal resources are reported as **Recoverable coal resources** to allow for losses during mining.

### Renewable Energy Resource Classification

Renewable energy resources are commonly transient and not always available, and hence not readily classified using the McKelvey system. Renewable resources are often reported in terms of output or installed capacity. Estimates of renewable resource potential are based on maps that show the energy (or power) potentially or theoretically available at the site and detailed studies of the annual and diurnal variation in the energy to determine the capacity factor (the average actual energy output compared with the theoretical maximum possible output if the energy was continuously and fully available for use).

A code based on JORC – the Australian Code for Reporting of Exploration Results, Geothermal Resources and Geothermal Reserves – has been developed for the public reporting of geothermal exploration results and classification of geothermal resources and reserves, covering all forms of geothermal energy. **Geothermal reserves** are energy that is commercially recoverable now, whereas ‘Geothermal resources’ require further work to be classified as ‘Geothermal reserves’.

## Appendix E: Energy Measurement and Conversion Factors

The basic international unit of energy across all energy types is the Joule (J). It is defined as the amount of work done by a force of one Newton exerted over a distance of one metre.

The basic unit of power – or energy per unit time – is the Watt (W), which is equal to one Joule per second. The common unit for electricity is watt (W or  $W_e$ ) which refers to electric power produced, while watt thermal ( $W_t$ ) refers to thermal (heat) power produced. Electricity usage (power consumption) is reported in kilowatt-hours per year (kWh/yr), the average rate at which energy is transferred.

Both Joules and Watts are more commonly recorded in multiples.

### Decimal numbering system

Multiples of energy measurements in Australia are expressed in standard international decimal classification terms:

Multiple	Scientific exp.	Term	Abbreviation
Thousand	$10^3$	Kilo	k
Million	$10^6$	Mega	M
Billion	$10^9$	Giga	G
Trillion	$10^{12}$	Tera	T
Quadrillion	$10^{15}$	Peta	P

### Energy measurement

Energy production and consumption are typically reported in the International System of Units (SI) as petajoules (PJ) as used here but in some cases are reported in barrels of oil equivalent (BOE) and million tonnes of oil equivalent (MTOE).

Individual energy resources are commonly reported according to prevailing industry conventions. Petroleum is reported by volume and weight according to either the SI or the United States system as used by the American Petroleum Institute.

In this report energy is reported in standard SI units (PJ) with the conventional volume or weight equivalent terms widely in use in industry in parentheses.

Energy resource	Measure	Abbreviation
Oil and condensate	<u>Production, reserves</u> : Litres (usually millions or billions) or barrels (usually thousands or millions) <u>Refinery throughput/capacity</u> : Litres (usually thousands or millions) or barrels per day (usually thousands or millions)	L, ML, GL bbl, kbbl, mmbbl ML, GL per day bd, kbd, mmbd
Natural gas	Cubic feet (usually billions or trillions) Or cubic metres (usually millions or billions of cubic metres)	bcf, tcf $m^3$ , mcm, bcm
LNG	Tonnes (usually millions) <u>Production rate</u> : Million tonnes per year	t, Mt Mtpa
LPG	Litres (usually megalitres) or barrels (usually millions)	L, ML bbl, mmbbl
Coal	Tonnes (usually millions or billions) <u>Production rate</u> : tonnes per year (usually kilotonnes or million tonnes per year)	t, Mt, Gt tpa, Mtpa
Uranium	Tonnes (usually kilotonnes) of uranium or of uranium oxide	t U; kt U t $U_3O_8$ ; kt $U_3O_8$
Electricity	<u>Capacity</u> : watts, kilowatts, etc <u>Production or use</u> : watt-hours, kilowatt-hours, etc	W, kW, MW ... Wh, kWh, MWh ...
Bioenergy • bagasse, biomass	Tonnes (or thousands of tonnes)	t, kt



## Fuel-specific to standard unit conversion factors

Oil and condensate	1 barrel	=	158.987 litres
	1 gigalitre (GL)	=	6.2898 million barrels
	1 tonne (t)	=	1250 litres (indigenous)/ 1160 litres (imported)
Ethanol	1 tonne	=	1266 litres
Methanol	1 tonne	=	1263 litres
<b>LPG</b>			
• average	1 tonne	=	1760 – 1960 litres
• naturally occurring	1 tonne	=	1866 litres
Natural gas	1 cubic metre (m <sup>3</sup> )	=	35.315 cubic feet (cf)
Liquefied natural gas	1 tonne	=	2174 litres
Electricity	1 kilowatt-hour (kWh)	=	3.6 megajoules (MJ)

## Energy content conversion factors

The energy content of individual resources may vary, depending on the source, the quality of the resource, impurities content, extent of pre-processing, technologies used, and so on. The following table provides a range of measured energy contents and, where appropriate, the accepted average conversion factor.

### a) Gaseous fuels

	PJ/bcf	MJ/m <sup>3</sup>
<b>Natural gas</b>		
• Victoria	1.0987	38.8
• Queensland	1.1185	39.5
• Western Australia	1.1751	41.5
• South Australia, New South Wales	1.0845	38.3
• Northern Territory	1.1468	40.5
• Average	1.1000 (54 GJ/t)	38.8
<b>Ethane (average)</b>	1.6282	57.5
<b>Town gas</b>		
• synthetic natural gas	1.1043	39.0
• other town gas	0.7079	25.0
• Coke oven gas	0.5125	18.1
• Blast furnace gas	0.1133	4.0

### b) Liquid fuels

	PJ/mmbbl	By volume MJ/L	By weight GJ/t
<b>Crude oil and condensate</b>			
• indigenous (average)	5.88	37.0	46.3
• imports (average)	6.15	38.7	44.9
<b>LPG</b>			
• propane	4.05	25.5	49.6
• butane	4.47	28.1	49.1
• mixture	4.09	25.7	49.6
• naturally occurring (average)	4.21	26.5	49.4
<b>Other</b>			
• Liquefied natural gas (North West Shelf )	3.97	25.0	54.4
<b>Naphtha</b>	4.99	31.4	48.1
<b>Ethanol</b>	3.72	23.4	29.6
<b>Methanol</b>	2.48	15.6	19.7

## c) Solid fuels

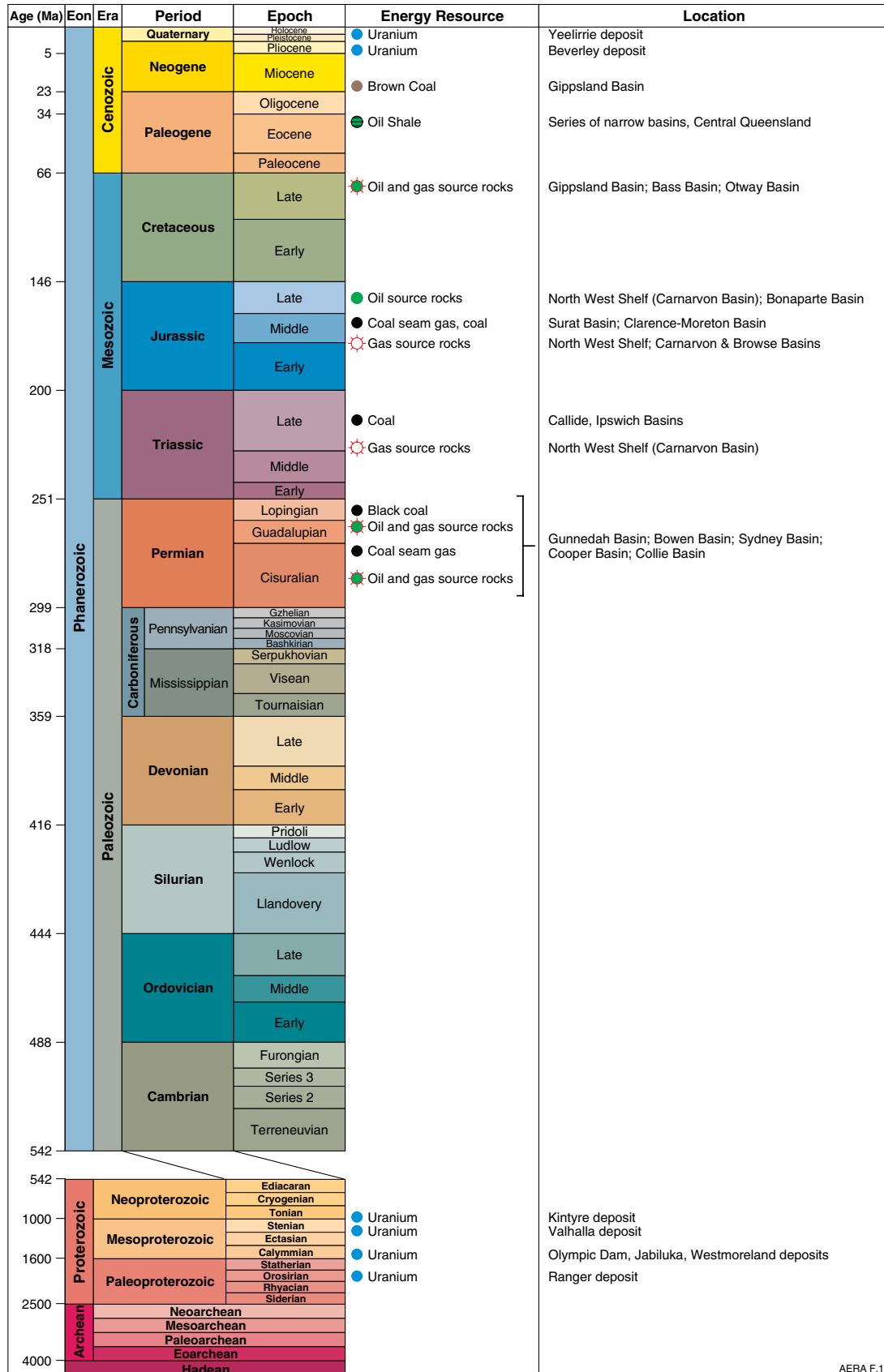
	GJ/t
<b>Black coal</b>	
<i>New South Wales</i>	
Exports – metallurgical coal	29.0
Exports – thermal coal	27.0
Electricity generation	23.4
Other	23.9 – 30.0
<i>Queensland</i>	
Exports – metallurgical coal	30.0
Exports – thermal coal	27.0
Electricity generation	23.4
Other	23.0
<i>Western Australia</i>	
Thermal coal	19.7
<i>Tasmania</i>	
Thermal coal	22.8
<b>Lignite (Brown Coal)</b>	
<i>Victoria</i>	9.8
Briquettes	22.1
<i>South Australia</i>	15.2
<b>Uranium*</b>	
Metal (U)	560 000
Uranium Oxide (U <sub>3</sub> O <sub>8</sub> )	470 000
<b>Other</b>	
Coke	27.0
Wood (dry)	16.2
Bagasse	9.6

\* The usable energy content of uranium metal (U) is 0.56 petajoules per tonne, and that of uranium oxide (U<sub>3</sub>O<sub>8</sub>) is 0.47 petajoules per tonne. The oxide contains 84.8 per cent of the metal by weight

Source: ABARE; Geoscience Australia

## Appendix F: Geological Time Scale and Formation of Australia's Major Energy Resources

The geological timing of some of the major non-renewable energy resources in Australia are charted. The geological time scale is based on Gradstein FM, Ogg J and Smith AG, A Geological Time Scale 2004, Cambridge University Press, New York.



Note: Ma = million years

AERA F.1